



POOLS

2021



www.grepool.com

■ índice ■ index ■ sommaire ■ indice

INTRODUCCIÓN INTRODUCTION INTRODUCTION INTRODUZIONE		Pag. 02
PISCINAS DE MADERA WOODEN POOL PISCINES BOIS PISCINA IN LEGNO		Pag. 06
PISCINAS DE COMPOSITE COMPOSITE POOLS PISCINES COMPOSITE PISCINA IN COMPOSITE		Pag. 28
PISCINAS DE ACERO STEEL WALL POOLS PISCINES PAROI ACIER PISCINA IN ACCIAIO		Pag. 34
PISCINAS ENTERRADAS IN-GROUND POOLS PISCINES ENTERRÉES PISCINE INTERRATA		Pag. 74
COMPLEMENTOS COMPLEMENTES COMPLEMENTES COMPLEMENTI		Pag. 82
MATERIAL DE LIMPIEZA CLEANING MATERIAL MATÉRIEL DE NETTOYAGE MATERIALE DI PULIZIA		Pag. 142
PRODUCTO QUÍMICO CHEMICALS PRODUITS D'ENTRETIEN CHIMICI		Pag. 176

■ Novedades ■ New products
■ Nouveautés ■ Nuovo



Nuevos modelos de piscinas de acero
New models of steel wall pools

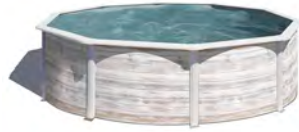

Nouveaux modèles de piscines en acier
Nuovi modelli di piscine pareti in acciaio

Nuevos modelos de piscinas de madera
New models of wooden pools
Nouveaux modèles de piscines bois
Nuovi modelli di piscine in legno



Enrollador solar piscinas enterradas
Solar cover roller for inground pools
Enrouleur solaire pour piscines enterrées
Avvolgitore solare per piscina interrata

Electrolisis de sal
Salt chlorinator
Electrolyse au sel
Elettrolisi salina



Nueva gama de bombas de calor
Heat pumps new range



Nouvelle gamme de pompes à chaleur
Nuova gamma di pompe di calore



Duchas
Showers
Douches
Docce



Escalera
Ladder
Échelle
Scaletta



Limpiafondos eléctricos
electric cleaners
nettoyeurs de fond électriques
pulitore elettrico per fondo piscina



Nueva gama de producto químico
New range of chemical product
Nouvelle gamme de produits chimiques
Nuova gamma di prodotti chimici

BOX





■ Presentación de la empresa

Gre es una empresa con más de 50 años de experiencia en la fabricación de piscinas elevadas.

Como empresa pionera en el sector, somos especialistas y líderes a nivel europeo.

Nuestra apuesta clara por la calidad y seguridad de todos nuestros productos, nos convierte en la referencia fundamental del mercado.

Nuestra empresa ofrece una amplia gama de productos: piscinas elevadas de diferentes formatos y acabados, una completa línea de accesorios para su equipamiento y mantenimiento y una serie de productos químicos diseñados específicamente para el agua de la piscina.

Con el ánimo siempre, de satisfacer al cliente, Gre ha diseñado una estrategia de servicios, cuyo objetivo es ofrecer una solución integral. Nuestra amplia red de Servicios Técnicos, así como nuestros Departamentos de Atención al Cliente, son la mejor prueba de ello. Estos servicios nos permiten asesorarle sobre la opción de piscina y equipamiento más adecuados a sus necesidades.

■ Présentation de l'entreprise

Gre est une société spécialisée dans la fabrication de piscines hors-sol.

Pionnière dans le secteur, notre entreprise est SPÉCIALISTE et LEADER en EUROPE.

Notre pari sur la QUALITÉ et la SÉCURITÉ de tous nos produits nous permet d'être la principale RÉFÉRENCE du marché.

Notre entreprise offre une LARGE GAMME de produits, allant des piscines hors-sol aux tailles et finitions diverses et variées, jusqu'à un éventail complet des accessoires nécessaires à l'équipement et à l'entretien, et une gamme de produits chimiques conçus spécifiquement pour l'eau de la piscine.

Toujours dans le but de satisfaire les clients, Gre a conçu une stratégie de SERVICES dont l'objectif est d'offrir une réponse et une solution complètes grâce à son large réseau de Services Techniques et à son Service client. Ces services nous permettent de vous conseiller tant sur le choix de votre piscine que de l'équipement le plus approprié à vos besoins.

■ Company presentation

Gre is a company with more than 50 years experience in manufacturing above-ground pools.

As a pioneer company on its field, we are SPECIALISTS and LEADERS within the European market.

We are considered to be a fundamental market REFERENCE as a result of our clear wager on QUALITY and SECURITY of all our products.

Our company offers a WIDE RANGE of products which includes: different sizes and finishes aboveground pools, a complete range of accessories for their equipment and maintenance and a number of swimming pool chemicals designed specifically for the pool water.

Bearing in mind our customers satisfaction, Gre has designed an important SERVICES strategy whose aim is to offer an integral solution. Our wide network of Technical Services and our Customer Service Departments are the best proof of that. These services help us to identify our customers needs and to advise them on the best pool and equipment according to those needs.

■ Presentazione dell'azienda

La Gre è un'azienda con oltre 50 anni di esperienza nella produzione di piscine smontabili su terra.

Come impresa pioniera nel settore, siamo SPECIALISTI e LEADER a livello EUROPEO.

La nostra chiara scommessa sulla QUALITÀ e sulla SICUREZZA di tutti i nostri prodotti, fa di noi il RIFERIMENTO fondamentale del mercato.

La nostra società offre una VASTA GAMMA di prodotti: piscine elevate di diversi formati e rifiniture, una completa linea di accessori per l'attrezzatura e la manutenzione e una serie di prodotti chimici pensati specificamente per l'acqua della piscina.

Sempre con l'intenzione di soddisfare il cliente, la Gre ha progettato una strategia di SERVIZI il cui scopo è quello di offrire una soluzione integrale. La nostra vasta rete di Servizi Tecnici, così come i nostri Reparti di Servizio al Cliente, ne sono la miglior prova. Tali servizi ci consentono di dare consulenza sulla scelta della piscina e dell'equipaggiamento più idoneo alle vostre necessità.

■ Certificaciones ■ Certifications ■ Certifications ■ Certificazioni

MADE IN EUROPE

Todas las piscinas fabricadas por Manufacturas GRE S.A. Son de origen CE - Comunidad Europea.

Toutes les piscines fabriquées par Manufacturas Gre S.A. sont d'Origine CE - Communauté Européenne.

All the pools manufactured by Manufacturas Gre S.A. are of EC - European Community origin.

Tutte le piscine prodotte da Manufacturas Gre S.A. sono di origine CE - Comunità Europea.



ISO 9001

Los procesos utilizados para el diseño, la fabricación y comercialización de piscinas desmontables de Manufacturas Gre S.A., así como la comercialización de productos asociados, están certificados siguiendo los criterios de sistema de Gestión de Calidad según la norma internacional ISO9001:2015, lo cual garantiza regularidad y control en la calidad de nuestros productos y procesos.

Les processus utilisés pour la conception, la fabrication et la commercialisation de piscines hors-sol de Manufacturas Gre S.A., ainsi que la commercialisation de produits associés, sont certifiés conformes aux critères du système de Gestion de Qualité, selon la norme internationale ISO9001:2015.

The processes used for the design, manufacturing and commercialisation of dismantable pools by Manufacturas Gre S.A., as well as the commercialisation of associated products, are certified according to the Quality System according to the international ISO9001:2015 standard, which guarantees regularity and control in the quality of our products and processes.

I processi utilizzati per la progettazione, la costruzione e la vendita di piscine smontabili a marchio Manufacturas Gre S.A., oltre alla vendita di prodotti ad esse associati, sono certificati in base ai criteri del sistema di Gestione della Qualità secondo la norma internazionale ISO9001:2015, ciò garantisce la regolarità e il controllo della qualità dei nostri prodotti e dei processi produttivi.



ISO 14001

Gracias a la implantación de un Sistema de Gestión Ambiental según la norma internacional ISO 14001: 2015, Manufacturas Gre S.A. se posiciona como una empresa socialmente responsable. Entre otras ventajas ambientales, optimizamos la gestión de recursos y residuos, reduciendo los impactos ambientales negativos derivados de nuestra actividad o aquellos riesgos asociados a situaciones accidentales.

Grâce à l'implémentation d'un Système de Gestion Environnementale conformément à la norme internationale ISO 14001:2015, Manufacturas Gre S.A. se positionne comme une entreprise socialement responsable. Parmi de nombreux avantages environnementaux, nous optimisons la gestion des ressources et des déchets, réduisant ainsi les impacts environnementaux négatifs et dérivés de notre activité ou les risques associés à des situations d'accidents.

Thanks to the implantation of an Environmental Management System according to the international ISO 14001:2015 standard, Manufacturas Gre S.A. is positioned as a socially responsible company. Among other environmental advantages, we optimise resources and residues, reducing negative environmental impact derived from our activity or those risks associated to accidental situations.

Grazie all'introduzione di un Sistema di Gestione Ambientale secondo la norma internazionale ISO 14001:2015, Manufacturas Gre S.A. si classifica tra le aziende socialmente responsabili. Ciò comporta vantaggi per l'ambiente come l'ottimizzazione della gestione delle risorse, la riduzione degli impatti ambientali negativi derivanti dall'attività di produzione o dei rischi associati a eventi accidentali.



ARBITRAJE DE CONSUMO / CONSUMER ARBITRATION / ARBITRAGE DE CONSOMMATION / ARBITRATO DI CONSUMO

Manufacturas Gre S.A. está adherido a la Junta Arbitral de Consumo como muestra de predisposición a la solución amistosa de cualquier tipo de reclamación por parte de sus clientes.

Manufacturas Gre S.A. est membre du bureau d'Arbitrage de Consommation, comme preuve de sa prédisposition à trouver une solution amiable face à tout type de réclamation de la part de ses clients.

Manufacturas Gre S.A. is adhered to the Consumer Arbitration Directorate evidencing predisposition to a friendly solution to any type of reclamation from its clients.

Manufacturas Gre S.A. aderisce alla Giunta Arbitrale di Consumo come segnale di predisposizione alla soluzione amichevole di qualsiasi tipo di reclamo da parte dei propri clienti.



CE

Los productos distribuidos por Manufacturas Gre S.A. con el marcado CE cumplen todos los requisitos legales vigentes en Europa.

Les produits distribués par Manufacturas Gre S.A. et dotés du marquage CE répondent à toutes les obligations légales en vigueur en Europe.

The products distributed by Manufacturas Gre S.A., with the CE marking comply with all the legal requirements in force in Europe.

I prodotti distribuiti da Manufacturas Gre S.A. con il marchio CE rispettano tutti i requisiti legali vigenti in Europa.





EN 16582-1:2015, EN 16582-3:2015, EN 16713-1:2015

Estas certificaciones garantizan que las piscinas, filtros y escaleras fabricados y/o distribuidos por Manufacturas Gre S.A. cumplen con las normativas de seguridad establecidas.

These certifications guarantee that the pools, filters and stepladders manufactured and/or commercialised by Manufacturas Gre S.A. comply with the established safety regulations.

Ces certifications garantissent que les piscines, les filtres et les échelles fabriqués et/ou distribués par Manufacturas Gre S.A. respectent les normes de sécurité établies.

Queste certificazioni garantiscono che le piscine, i filtri e le scalette prodotti e/o distribuiti da Manufacturas Gre S.A. rispettano le normative di sicurezza previste.



ECOEMBES

Manufacturas Gre S.A. está adherida a un sistema de recogida y reciclaje selectivo de los materiales que pone en el mercado con el fin último de preservar el medio ambiente.

Manufacturas Gre S.A. is adhered to a system for the selective collection and recycling of the materials it puts on the market in order to conserve the environment.

Manufacturas Gre S.A. est membre d'un système de collecte et de recyclage sélectif des matériaux qu'elle met sur le marché, dans le but de préserver l'environnement.

Manufacturas Gre S.A. aderisce a un sistema di raccolta differenziata e riciclaggio dei materiali immessi sul mercato, in un'ottica di preservazione dell'ambiente.



REACH

Manufacturas Gre S.A. cumple con el reglamento Reach asegurando que todas las sustancias químicas que comercializa están registradas.

Manufacturas Gre S.A. complies with the Reach regulation ensuring that all the chemical substances it commercialises are registered.

Manufacturas Gre S.A. respecte le règlement Reach, qui garantit que toutes les substances chimiques qu'elle commercialise sont enregistrées.

Manufacturas Gre S.A. rispetta il regolamento Reach garantendo la registrazione di tutte le sostanze chimiche immesse sul mercato dall'azienda.

RoHS

ROHS

Manufacturas Gre S.A. cumple esta directiva para proteger el medio ambiente y la salud de las personas, evitando el uso de determinadas sustancias en aparatos eléctricos y electrónicos.

Manufacturas Gre S.A. complies with this directive to protect the environment and health of persons, avoiding the use of determined substances in electrical and electronic devices.

Manufacturas Gre S.A. respecte cette directive afin de protéger l'environnement et la santé des personnes, évitant ainsi l'utilisation de substances déterminées dans les appareils électriques et électroniques.

Manufacturas Gre S.A. rispetta questa normativa per proteggere l'ambiente e la salute delle persone, evitando l'utilizzo di determinate sostanze su dispositivi elettrici ed elettronici.



PEFC

Manufacturas Gre S.A. cumple con los requisitos del Estándar de Cadena de Custodia de Productos Forestales PEFC ST 2002:2013.

Manufacturas Gre S.A. complies with the requirements of the Programme for the Endorsement of Forest Certification PEFC ST 2002:2013.

Manufacturas Gre S.A. respecte les conditions du Standard de la Chaîne de Contrôle de Produits Forestiers PEFC ST 2002:2013.

Manufacturas Gre S.A. rispetta i requisiti previsti dallo Standard della catena di custodia dei prodotti forestali PEFC ST 2002:2013.



Origine France Garantie

Origine France Garantie es una marca cuyo principio es simple: 2 criterios son obligatorios.
· Al menos el 50% del costo unitario es francés.
· El producto tiene sus características esenciales en Francia.
La etiqueta permite a las empresas **promover la producción en Francia** y los consumidores pueden optar por **comprar producto francés**.

Origine France Garantie is a brand whose principle of achievement is simple: 2 cumulative criteria are mandatory.
· At least 50% of the unit cost is French.
· The product has its essential characteristics in France.
The label allows companies to **promote production in France** and **consumers can choose to buy French**.

Origine France Garantie est une marque dont le principe d'obtention est simple : 2 critères cumulatifs sont obligatoires.
· Au moins 50 % du prix de revient unitaire est français.
· Le produit a ses caractéristiques principales en France.
Le label permet aux entreprises de promouvoir la **production en France** et aux consommateurs de pouvoir **choisir d'acheter français**.

Origine France Garantie è un marchio il cui principio di realizzazione è semplice: 2 criteri cumulativi sono obbligatori.
· Almeno il 50% del costo unitario è francese.
· Il prodotto ha le sue caratteristiche essenziali in Francia.
L'etichetta consente alle aziende di **promuovere Producono in Francia** e i consumatori **possono scegliere di acquistare il francese**.

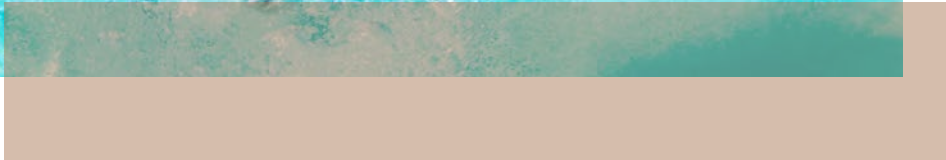

PISCINAS DE MADERA

LINER: Tratamiento Anti-ultravioleta que retrasa el envejecimiento del P.V.C

MADERA: Fabricadas en Francia en pino silvestre francés y con tratamiento en autoclave clase IV que garantiza la resistencia de la madera contra el ataque de insectos y pudrimiento. 10 años de garantía sobre la madera.

WOODEN POOL

LINER: Anti-ultraviolet treatment to slow down P.V.C aging.

WOODEN: Manufactured in France with pine boards (originating in France), with a class IV autoclave treatment which guarantees its resistance to decay and xylophagous insects attack.

PISCINE BOIS

LINER: Traitement anti-ultraviolets contre le vieillissement du P.V.C.

BOIS: De fabrication française et réalisées à partir de madriers en pin (origine France), nos piscines bois bénéficient d'un traitement par autoclave de classe IV, ce qui garantit une résistance au pourrissement et aux attaques d'insectes xylophages. 10 ans de garantie sur les composants bois de la piscine.

PISCINA IN LEGNO

LINER: Trattamento Anti-ultravioletti - Ritarda l'invecchiamento del P.V.C.

LEGNO: Prodotte in Francia in pino silvestre francese con trattamento in autoclave classe IV che garantisce la resistenza del legno agli insetti e al deterioramento. 10 anni di garanzia sulle parti in legno.



**MADE
IN
EU**

■ La madera una historia ■ The wood a story ■ Le bois une histoire ■ Il bosco una storia

PINO SILVESTRE

Manufacturas Gre presenta piscinas con estructuras de madera de **pino silvestre**. Con un planteamiento de desarrollo sostenible, **Manufacturas Gre** cuenta **exclusivamente** con proveedores **locales en Francia**, de bosques de pinos denominados «del país». Asimismo, limitamos el transporte y las emisiones de gases de efecto invernadero. El PINO es la esencia de la clase de uso del autoclave IV, que garantiza resistencia frente a la podredumbre y a los insectos xilófagos.

El denominado pino «del país» presenta **más albura** que los pinos procedentes de bosques septentrionales. Además, ofrece **una zona de impregnación más significativa**, lo que asegura una vida útil superior a los diez años debido a una impregnación profunda en el autoclave. Este último es el único procedimiento normalizado y garantizado que aporta garantías a la durabilidad.

LE PIN SYLVESTRE

Manufacturas Gré propose des piscines à ossature bois en pin sylvestre. Dans une logique de développement durable, **Manufacturas Gré** s'approvisionne **localement et exclusivement en France**, auprès de forêts de pin dit « de pays ». Nous limitons ainsi le transport et les émissions de gaz à effet de serre.

Le PIN est l'essence idéale pour la classe d'emploi autoclave IV, garantissant une résistance au pourrissement et aux attaques d'insectes xylophages. Le pin dit « de pays » présente **plus d'aubiers** que les pins des forêts du nord. Il offre ainsi **une zone d'impregnation plus importante** lui garantissant une durée de service supérieure à 10 ans grâce à l'impregnation profonde en autoclave. Ce dernier est le seul procédé normalisé et certifié apportant des garanties dans la durée.



SCOTS PINE

Manufacturas Gre presents pools with **Scots pine** wood structures. With its proposal for sustainable development, **Manufacturas Gré** exclusively uses **local French** suppliers, from forests of pine wood denominated «local pine». Likewise, we limit transport and emissions of greenhouse gases. PINE is the essence of the class used in Autoclave IV that guarantees resistance against rot and xylophagous insects.

The so-called «local pine» has **more whiteness** than pines coming from northern forests. In addition, it offers **a more significant impregnation area**, which assures a useful life above ten years due to deeper impregnation in the autoclave. This latter is the only standardised and guaranteed process proving guaranteed durability.

PINO SILVESTRE

Manufacturas Gre è lieta di presentare le piscine con struttura in legno di **pino silvestre**.

Con un approccio rivolto allo sviluppo sostenibile, **Manufacturas Gre** si affida **esclusivamente** a fornitori **locali in Francia**, di legno proveniente da foreste di pini "autoctoni".

Vengono limitati il trasporto e le emissioni di gas serra.

Il PINO subisce un trattamento in autoclave classe IV, che garantisce resistenza al deterioramento e agli insetti xilofagi.

Il cosiddetto pino "autoctono" presenta una quantità maggiore di **alburno** rispetto ai pini provenienti dalle foreste settentrionali. Offre inoltre **una maggiore area di impregnazione**, che garantisce una durata utile superiore a dieci anni grazie a una profonda impregnazione in autoclave. Quest'ultima è l'unica procedura standardizzata e garantita che apporta garanzie di durabilità.



CERTIFICACIONES

PRODUCTOS CERTIFICADOS POR **PEFC** (Programa europeo de certificación forestal)
Licencia número: PEFC/14-38-00166
Pioneros en la certificación forestal en Francia, PEFC acoge en la actualidad 8,1 millones de hectáreas, 62 000 propietarios y 3000 empresas del sector maderero forestal (explotaciones, aserraderos, industrias de transformación, construcciones, intermediarios comerciales, distribuidores, industrias papeleras, imprentas, editoriales, etc.). En conjunto, aportan al consumidor la garantía de que el producto que lleve la marca PEFC se enmarca en una estrategia responsable de gestión forestal sostenible.

CERTIFICATION

PRODUITS LABELLISÉS **PEFC** (Programme Européen des Forêts Certifiées)
N° licence : PEFC/14-38-00166
Pionnier de la certification forestière en France, PEFC représente aujourd'hui 8,1 millions d'hectares, 62 000 propriétaires et 3 000 entreprises de la filière forêt-bois (exploitants, scieries, transformateurs, constructeurs, négociants, artisans, distributeurs, papetiers, imprimeurs, éditeurs...). Ensemble, ils apportent au consommateur la garantie qu'un produit portant la marque PEFC s'inscrit dans une démarche responsable de gestion durable de la forêt.

www.pefc.es / www.pefc-france.org

Nuestra madera procede de bosques gestionados de forma responsable y sostenible, certificados como PEFC™. Our wood comes from responsibly and sustainably managed forests, certified with PEFC™. Notre bois est issu de forêts gérées de façon responsable et durable, certifiées PEFC™. Il nostro legno proviene da foreste gestite in modo responsabile e sostenibile, certificate come PEFC™.

CERTIFICATION

PRODUCTS CERTIFIED BY **PEFC** (European programme for forestry certification)
License number: PEFC/14-38-00166
Pioneers in forestry certification in France, PEFC currently includes 8.1 million hectares, 62,000 owners, and 3,000 forest timber sector companies (exploitations, sawmills, transformation industries, constructions, commercial intermediaries, distributors, paper industries, printers, publishers, etc.). Overall, the provide the consumer with the guarantee that the product with PEFC marking is framed within a responsible strategy of sustainable forest management.

CERTIFICAZIONE

PRODOTTI CERTIFICATI DAL **PEFC** (Programma europeo di certificazione forestale)
Licenza numero: PEFC/14-38-00166
Pionieri nella certificazione forestale in Francia, PEFC conta attualmente 8,1 milioni di ettari, 62.000 proprietari e 3000 aziende nel settore del legno (aziende agricole, segherie, industrie di trasformazione, settore edile, intermediari commerciali, distributori, cartiere, stamperie, editorie, ecc.). Uniti nell'intento di offrire ai consumatori la garanzia che il prodotto a marchio PEFC faccia parte di una strategia responsabile per la gestione sostenibile delle foreste.

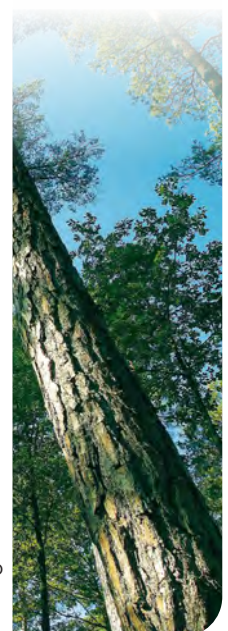



La certificación **CTB B+** solo indica el uso de un producto de tratamiento conforme a los criterios de la certificación. Pivetau Bois cuenta con la certificación **CTB B+** (con el respaldo de la asociación Arbust). El certificado CTB B+ confirma la utilización de productos de tratamiento con la **certificación CTB B+**, así como la **conformidad del proceso y su eficacia**.

Le CTB P+ atteste uniquement de l'utilisation d'un produit de traitement conforme aux critères de la certification. Pivetau Bois est certifié CTB B+ (soutenu par l'association Arbust). Le certificat CTB B+ atteste de l'utilisation de produit de traitement certifié CTB P+ et **atteste aussi de la conformité du processus et de son efficacité**.

The **CTB B+** certification only indicates the use of a treatment product in accordance to certification criteria. Pivetau Bois has the CTB B+ certification (with the backing of the Arbust association). The **CTB B+** confirms the use of treatment products with **CTB B+ certification**, as well as **process conformity and efficiency**.

La certificazione **CTB B +** indica l'utilizzo di un prodotto di trattamento conforme ai criteri della certificazione. Pivetau Bois è in possesso della certificazione **CTB B +** (con il supporto dell'associazione Arbust). La certificazione **CTB B +** conferma l'utilizzo di prodotti per il trattamento con la certificazione **CTB B +**, nonché la **conformità del processo e la sua efficacia**.

■ Tratamiento autoclave ■ Autoclave treatment ■ Le traitement autoclave ■ Trattamento in autoclave

El tratamiento en el autoclave es **la mejor solución** para proteger las maderas expuestas de forma directa a la intemperie o en contacto con el suelo y consiste en **impregnar conservantes hasta el núcleo de la madera**.

Le traitement par autoclavage est **la meilleure solution** pour protéger les bois directement exposés aux intempéries ou en contact avec le sol et consiste à **impregner des agents de conservation jusqu'au cœur du bois**.

Treatment in the autoclave is **the best solution** for protecting wood directly exposed to outdoor weather or in contact with the ground and consists of **impregnating preservatives into the core of the wood**.

Il trattamento in autoclave è la **soluzione migliore** per proteggere il legno esposto direttamente alle intemperie o a contatto con il terreno e consiste **nell'impregnare conservanti nel nucleo del legno**.



INSTALCIÓN

Libre elección de instalación: en superficie, semienterrada o enterrada. En estos dos últimos casos, es obligatorio acondicionar un drenaje en todo el perímetro del vaso (consultar el aviso).

IMPLANTATION

Implantation libre de choix : hors-sol, semi-enterrée jusqu'à complètement enterrée. En cas d'implantation semi-enterrée ou totalement enterrée, il est impératif de réaliser un drainage sur toute la périphérie du bassin (cf notice).

INSTALLATION

Free choice of installation: above ground, semi in-ground or in-ground. In these two latter cases, there must be drainage in the entire perimeter of the pool (check warning).

INSTALLAZIONE

Libera installazione: superficiale, semi-interrata o interrata. In questi ultimi due casi, è obbligatorio predisporre un drenaggio attorno al perimetro della vasca (consultare le specifiche indicazioni).

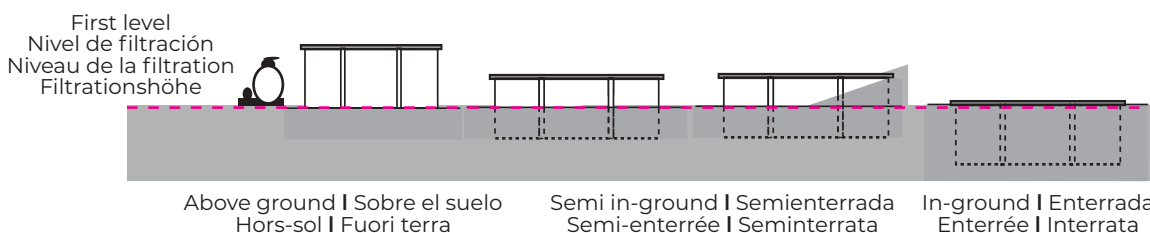

All the dimensions of our pools are presented with a tolerance of +/- 3% · Todas las dimensiones de nuestras piscinas se presentan con una tolerancia de +/- 3% · Toutes les dimensions de nos piscines sont données avec une tolérance de +/- 3% · Tutte le dimensioni delle nostre piscine vengono indicate con una tolleranza di +/- 3%.

■ Piscinas de madera ■ Wooden pools ■ Les piscines en bois
■ Piscine in legno

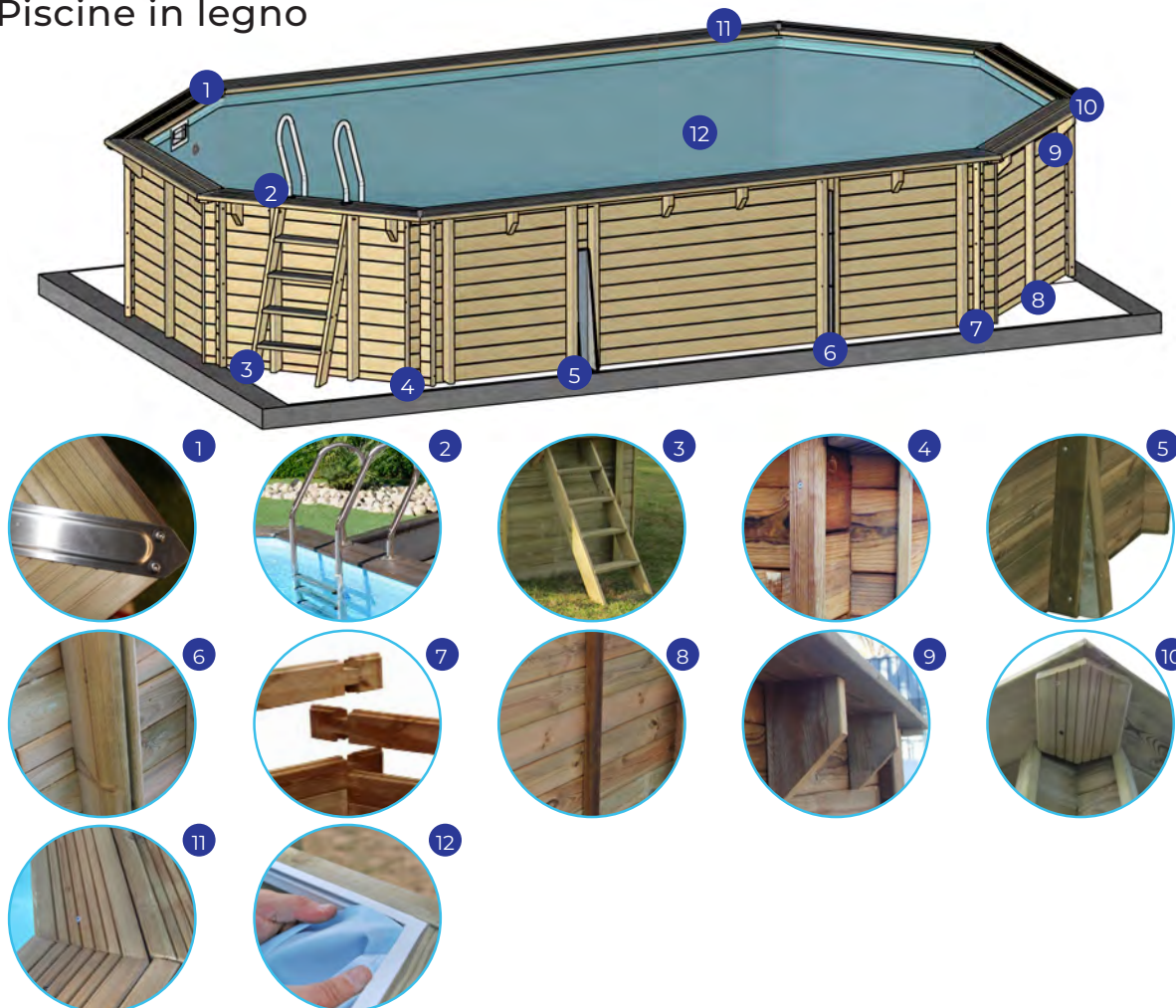

1: Stainless steel corners According to model **2: Stainless steel ladder** Fixed - 3 non-slip steps **3: Wood ladder** Possibility of readjusting the wood ladder according to the height of the pool. **4: Angular finishing** The wood coating at the ends of the boards provides greater aesthetics to the pool **5: Wedges** Reinforcement wedges for fixing on concrete slab **6: Nerves** Metallic nerves for embedding in concrete slab or omega system (optional concrete slab) **7: Tongue and groove series** Boards are fitted to each other by a cross at the end - Simple tongue and groove facilitating assembly and that way avoiding risk of breakage. **8: Vertical reinforcements** Vertical resistance thanks to wood reinforcements **9: Corbels** Corbels are used to sustain the edges **10: Plates under edges** Allow reinforcing the installation of edges on the corners **11: Wood edges** Made from Scots pine treated in class IV autoclave - Single (190 mm) or double (2 x 145 mm) according to model - Thickness of 28 mm or of 36 mm according to model **12: Liner** Baguettes Hung

1: Embellecedor de esquinas inoxidable Según el modelo **2: Escalera inoxidable** Fija - 3 Escalones antideslizantes **3: Escalera de madera** Posibilidad de reajustar la escalera de madera según la altura del vaso **4: Embellecedor angular** El revestimiento de madera en los extremos de los tabloncillos perfecciona la estética del vaso **5: Cuñas metálicas** Cuñas de refuerzo para fijar sobre la losa de hormigón **6: Vigas** Vigas metálicas para encastrar en la losa de hormigón o sistema de omegas (los de hormigón opcional) **7: Conjunto de ranura y lengüeta** Encaje de tabloncillos entre ellos mediante cruce de los extremos - Ranura y lengüeta sencillas para facilitar el montaje y así evitar el riesgo de rotura **8: Refuerzos verticales** Resistencia vertical gracias a los refuerzos de madera **9: Tacos de madera** Los tacos se emplean para sostener las playas **10: Tacos bajo playa** Permiten reforzar la instalación de las playas en las esquinas **11: Playas de madera** De pino silvestre tratado en autoclave de clase IV - Simple (190 mm) o doble (2 x 145 mm) según el modelo - Grosor de 28 mm o de 36 mm según el modelo **12: Liner** Perfil colgate

1: Caches angles Inox Selon modèle **2: Échelle Inox** Amovible - 3 marches anti-dérapantes **3: Échelle Bois** Possibilité de réajuster l'échelle bois selon la hauteur du bassin **4: Cache L** Un habillage bois aux extrémités des madriers vient parfaire l'esthétisme du bassin **5: Sabots** Renforts sabot à fixer sur la dalle béton **6: Berceaux** Berceaux métalliques à noyer dans la dalle béton ou renforts enterrés (dalle béton facultative) **7: Assemblage Rainure languette** Emboîtement des madriers les uns sur les autres en se croisant à leurs extrémités - Simple rainure / languette pour faciliter le montage et éviter ainsi le risque de casse **8: Renforts verticaux** Résistance verticale grâce aux renforts bois **9: Consoles** Les consoles sont destinées à soutenir les margelles **10: Plaques sous margelles** Permet de renforcer l'assemblage des margelles dans les angles **11: Margelles Bois** En pin Sylvestre traité autoclave classe IV - Simple (190 mm) ou double (2 x 145 mm) selon modèle - Épaisseur 28 mm ou 36 mm selon modèle **12: Liner** Baguettes Hung

1: Rivestimento per angoli in acciaio inox In base al modello **2: Scaletta in acciaio inox** Fissa - 3 scalini antiscivolo **3: Scaletta in legno** Possibilità di regolare la scaletta in base all'altezza della vasca **4: Rivestimento angolare** Il rivestimento in legno posto alle estremità dei pannelli perfeziona l'estetica della vasca **5: Cunei** Cunei di rinforzo da fissare sulla lastra in calcestruzzo **6: Nervature** Nervature metalliche da incastrare nella lastra in calcestruzzo o sistema omega (basamento di calcestruzzo opzionale) **7: Set composto da scanalatura e linguetta** Incastrare i pannelli tra loro incrociando le estremità - Scanalatura e linguetta per facilitare il montaggio evitando il rischio di rottura **8: Rinforzi verticali** Resistenza verticale grazie ai rinforzi in legno **9: Mensole** Le mensole vengono utilizzate per sostenere i bordi **10: Piastrine poste sotto al bordo** Permettono di rinforzare i bordi negli angoli **11: Bordi in legno** Realizzati in legno di pino silvestre con trattamento in autoclave in classe IV - Semplice (190 mm) o doppio (2 x 145 mm) a seconda del modello - Spessore 28 mm o 36 mm a seconda del modello **12: Liner** Baguettes Hung

■ Refuerzos de estructura ■ Structural reinforcements ■ Renforts de structure ■ Rinforzi strutturali

CUÑA METÁLICA :

La cuña se fija sobre la losa de hormigón. Por lo tanto, permite construir la losa, con un espesor mínimo de 15 cm, antes de montar el vaso (consultar el manual de instalación y el vídeo de montaje). Los refuerzos tienen un revestimiento de madera para garantizar su integración y su estética.

LES SABOTS :

Le sabot vient se fixer sur la dalle en béton. Il est donc possible de réaliser la dalle, épaisseur 15 cm minimum, préalablement au montage du bassin (cf. notice de montage et vidéo de montage). Les renforts de structure reçoivent un habillage bois, pour une intégration et un esthétisme assuré.

WEDGE :

The wedge is fixed on the concrete slab. Therefore, this allows preparing the concrete slab, with minimum thickness of 15 cm before assembling pool (check installation warning and assembly video). Structural reinforcements are covered with wood to guarantee their integration and aesthetics.

CUNEO METALLICO :

Il cuneo viene fissato sulla lastra di calcestruzzo. Consente pertanto di costruire la lastra, con uno spessore minimo di 15 cm, prima di montare la vasca (consultare le indicazioni e il video di montaggio). I rinforzi strutturali sono provvisti di una copertura in legno che ne migliorano il posizionamento e l'estetica.

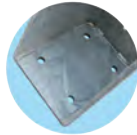

VIGAS METÁLICAS (IPE):

Las vigas metálicas se encastran en la losa de hormigón, con un espesor mínimo de 17 cm. Su colocación forma parte del proceso de montaje de la estructura (consultar el manual de instalación).

BERCEAUX (IPE):

Les berceaux métalliques sont à noyer dans la dalle béton, épaisseur 17 cm minimum. Leur pose fait partie intégrante du montage de la structure (cf. notice de montage).

BURIED STEEL BEAMS (IPE):

Buried steel beams are embedded in the concrete slab, with a minimum thickness of 17 cm. Their installation is part of the structure assembly process (check installation warning).

BARRA DI ACCIAIO (IPE):

La barra di acciaio vengono incassate nella lastra di calcestruzzo, con uno spessore minimo di 17 cm. Il loro posizionamento fa parte del processo di assemblaggio della struttura (vedere indicazioni per il montaggio).

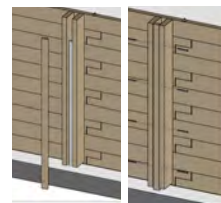
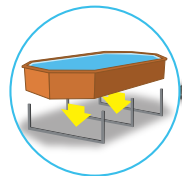

SISTEMA DE OMEGAS:

Viga de acero enterrada de 15x15 cm. Es necesario excavar y preparar el terreno para nivelarlo. Losa de hormigón opcional.

RENFORTS ENTERRÉS:

Poteaux en acier à enterrer de 15x15 cm. Il est nécessaire de décapoter votre terrain et de mettre le terrassement de niveau. Dalle béton facultative.

OMEGA SYSTEM:

15x15 cm buried steel beam. You should excavate and prepare the land for levelling. Optional concrete slab.

SISTEMA OMEGA:

Barra di acciaio interrata da 15x15 cm. È necessario scavare e preparare il terreno per livellarlo. Basamento di calcestruzzo opzionale.

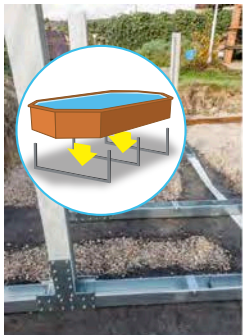

wooden pools **CARDAMON · MINT · BRAGA**

H. 1,46 m



788033 CARDAMON



790207 BRAGA

REFERENCIA | RÉFÉRENCE |
REFERENCE | RIFERIMENTO



CÓDIGO | GENCOD |
EAN CODE | CODICE A BARRE



EXTERIORES | EXTÉRIEURES |
OUTSIDE | ESTERNO



INTERIORES | INTÉRIEURES |
INSIDE | INTERNI



VOLUMEN DE AGUA | VOLUME D'EAU | WATER
VOLUME | VOLUME DI ACQUA



LÍNEA DE AGUA | LIGNE D'EAU |
WATER LINE | LINEA DELL'ACQUA



MADERA | WOOD | BOIS | LEGNO



ESPESOR MADERA | ÉPAISSEUR MADRIER |
WOOD THICKNESS | DIMENSIONE



MACHIHEMBRADO | TONGUE AND GROOVE |
ASSEMBLAGE RAINURES LANGUETTES | INCASTRO



PLAYAS | MARGELLES | EDGES | BORDI

ANCHO | WIDTH | LARGEUR | LARGHEZZA

ESPESOR | THICKNESS | ÉPAISSEUR |
DIMENSIONE



EMBELLECEDORES METÁLICOS | METAL COVERS
CACHES ANGLES INOX | PROTEZIONE METALLICO



LINER



FILTRACIÓN | FILTRATION | FILTRO



PROTECTOR | FEUTRE | PROTECTOR | PROTEZIONE

FONDO | FLOOR | FOND



PARED | PARI | WALL | PARETE



ESCALERA INTERIOR | ÉCHELLE INTÉRIEURE |
INSIDE LADDER | SCALA INTERNA



ESCALERA EXTERIOR | ÉCHELLE EXTÉRIEURE |
OUTSIDE LADDER | SCALA ESTERNA



ESTRUCTURA | STRUCTURE |
STRUCTURE | STRUTTURA



ACCESORIOS | ACCESSORIES |
ACCESSOIRES | ACCESSORI
MADERA | WOOD | BOIS | LEGNO



INSTALACIÓN | INSTALLATION | INSTALLAZIONE

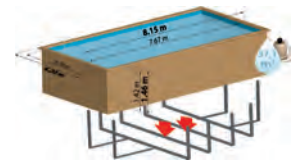
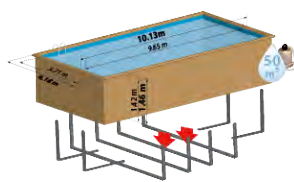
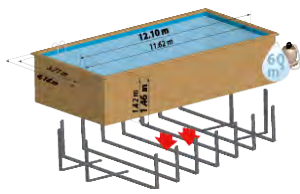

CARDAMON

MINT

BRAGA

788033

788032

790207
LDD: 790207D

3605217880338

3605217880321

3605217902078
LDD: 3605217902207

12,10 x 4,18 x H. 1,46 m

10,10 x 4,18 x H. 1,46 m

8,15 x 4,20 x H. 1,46 m

11,62 x 3,71 x H. 1,42 m

9,65 x 3,71 x H. 1,42 m

7,67 x 3,73 x H. 1,42 m

60 m³

50 m³

37 m³

1,36 m

1,36 m

1,36 m

Pino silvestre francés y autoclave clase IV · Pine boards originating in France, with a class IV autoclave · Pin sylvestre origine France autoclave classe IV · pino silvestre francese con trattamento in autoclave classe IV
Certificado · Certificate · Certifié · Certificato PEFC

46 mm

46 mm

46 mm

✓

✓

✓

Double
14,5 cm x 2 = 29 cm

Double
14,5 cm x 2 = 29 cm

Double
14,5 cm x 2 = 29 cm

3,6 cm

3,6 cm

3,6 cm

✓

✓

✓

75/100

75/100

75/100

FILTRO DE ARENA · SAND FILTER · FILTRATION À SABLE · FILTRO A SABBIA

10 m³/h - 2 skimmer

10 m³/h - 2 skimmer

10 m³/h - 2 skimmer

Espesor · Thickness · Épaisseur · Dimensione: 200 g/m²

✓

✓

✓

✓

✓

✓

ACERO INOXIDABLE · STAINLESS STEEL · ACIER INOXYDABLE · ACCIAIO INOX

MADERA · WOOD · BOIS · LEGNO



VIGAS METÁLICAS · BURIED STEEL BEAM · BERCEAUX METALLIQUES · BARRA DI ACCIAIO (IPE SYSTEM)

Losa de hormigón obligatorio · Obligatory concrete slab · Dalle béton Obligatoire · Basamento di calcestruzzo obbligatorio

1250 x 459 x H 17 cm
9,78 m³

1053 x 459 x H 17 cm
8,24 m³

856 x 461 x H 17 cm
6,72 m³

L 200 x l 80 x H 78 cm - 673 kg
L 405 x l 111 x H 102 cm - 2088 kg

L 200 x l 80 x H 78 cm - 612 kg
L 405 x l 111 x H 92 cm - 1730 kg

L 200 x l 80 x H 100 cm - 481 kg
L 405 x l 111 x H 77 cm - 1572 kg

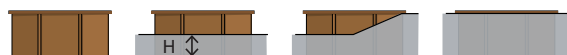

wooden pools EVORA · EVORA PLUS

H. 1,33 - H. 1,36 m



790206 EVORA



800009 EVORA PLUS

REFERENCIA | RÉFÉRENCE |
REFERENCE | RIFERIMENTO



CÓDIGO | GENCOD |
EAN CODE | CODICE A BARRE



EXTERIORES | EXTÉRIEURES |
OUTSIDE | ESTERNO



INTERIORES | INTÉRIEURES |
INSIDE | INTERNI



VOLUMEN DE AGUA | VOLUME D'EAU | WATER
VOLUME | VOLUME DI ACQUA



LINEA DE AGUA | LIGNE D'EAU |
WATER LINE | LINEA DELL'ACQUA



MADERA | WOOD | BOIS | LEGNO



ESPEJOR MADERA | ÉPAISEUR MADRIER |
WOOD THICKNESS | DIMENSIONE



MACHIHEMBADO | TONGUE AND GROOVE |
ASSEMBLAGE RAINURES LANGUETTES | INCASTRO



PLAYAS | MARGELLES | EDGES | BORDI



ANCHO | WIDTH | LARGEUR | LARGHEZZA

ESPEJOR | THICKNESS | ÉPAISEUR |
DIMENSIONE



EMBELLECEDORES METÁLICOS | METAL COVERS
CACHES ANGLES INOX | PROTEZIONE METALLICO



LINER



FILTRACIÓN | FILTRATION | FILTRO



PROTECTOR | FEUTRE | PROTECTOR | PROTEZIONE



FONDO | FLOOR | FOND



PARED | PARI | WALL | PARETE



ESCALERA INTERIOR | ÉCHELLE INTÉRIEURE |
INSIDE LADDER | SCALA INTERNA

ESCALERA EXTERIOR | ÉCHELLE EXTÉRIEURE |
OUTSIDE LADDER | SCALA ESTERNA



ESTRUCTURA | STRUCTURE |
STRUCTURE | STRUTTURA



TERRENO | TERRAIN | LAND | TERRENO



ACCESORIOS | ACCESSORIES |
ACCESSOIRES | ACCESSORI
MADERA | WOOD | BOIS | LEGNO



INSTALACIÓN | INSTALLATION | INSTALLAZIONE

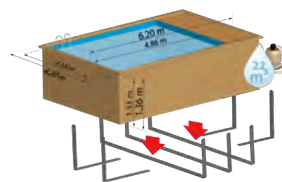

EVORA

EVORA PLUS

790206
 LDD: **790206D**

800009

3605217902061
 LDD: 3605217902191

8412081313870

6,20 x 4,20 x H. 1,33 m

6,20 x 4,20 x H. 1,36 m

5,70 x 3,73 x H. 1,30 m

4,86 x 3,73 x H. 1,33 m

24,1 m³

22 m³

1,20 m

1,23 m

Pino silvestre francés y autoclave clase IV · Pine boards originating in France, with a class IV autoclave · Pin sylvestre origine France autoclave classe IV · pino silvestre francese con trattamento in autoclave classe IV
 Certificado · Certificate · Certifié · Certificato PEFC

46 mm

46 mm



-

Double
 14,5 cm x 2 = 29 cm

Double
 14,5 cm x 2 = 29 cm

2,8 cm

2,8 cm



75/100

75/100

FILTRO DE ARENA · SAND FILTER · FILTRATION À SABLE · FILTRO A SABBIA

8 m³/h

8 m³/h

Espesor · Thickness · Épaisseur · Dimensione: 200 g/m²



ACERO INOXIDABLE · STAINLESS STEEL · ACIER INOXYDABLE · ACCIAIO INOX

MADERA · WOOD · BOIS · LEGNO



VIGAS METÁLICAS · BURIED STEEL BEAM · BERCEAUX METALLIQUES · BARRA DI ACCIAIO (IPE SYSTEM)

Losa de hormigón obligatorio · Obligatory concrete slab · Dalle béton Obligatoire · Basamento di calcestruzzo obbligatorio

659 x 461 x H 17 cm
 5,17 m³

659 x 461 x H 17 cm
 5,17 m³

L 200 x I 80 x H 100 cm - 400 kg
 L 405 x I 111 x H 77 cm - 1190 kg

L 200 x I 80 x H 100 cm - 425 kg
 L 405 x I 112 x H 72 cm - 1471 kg

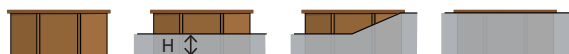

wooden pools MANGO · MARBELLA

H. 1,30 - H. 1,19 m



KPBRC620 MANGO



790096 MARBELLA

REFERENCIA | RÉFÉRENCE |
REFERENCE | RIFERIMENTO



CÓDIGO | GENCODE |
EAN CODE | CODICE A BARRE



EXTERIORES | EXTÉRIEURES |
OUTSIDE | ESTERNO



INTERIORES | INTÉRIEURES |
INSIDE | INTERNI



VOLUMEN DE AGUA | VOLUME D'EAU | WATER
VOLUME | VOLUME DI ACQUA



LÍNEA DE AGUA | LIGNE D'EAU |
WATER LINE | LINEA DELL'ACQUA



MADERA | WOOD | BOIS | LEGNO



ESPESOR MADERA | ÉPAISSEUR MADRIER |
WOOD THICKNESS | DIMENSIONE



MACHIHEMBADO | TONGUE AND GROOVE |
ASSEMBLAGE RAINURES LANGUETTES | INCASTRO



PLAYAS | MARGELLES | EDGES | BORDI

ANCHO | WIDTH | LARGEUR | LARGHEZZA

ESPESOR | THICKNESS | ÉPAISSEUR |
DIMENSIONE



EMBELLECEDORES METÁLICOS | METAL COVERS
CACHES ANGLES INOX | PROTEZIONE METALLICO



LINER



FILTRACIÓN | FILTRATION | FILTRO



PROTECTOR | FEUTRE | PROTECTOR | PROTEZIONE

FONDO | FLOOR | FOND



PARED | PAROI | WALL | PARETE



ESCALERA INTERIOR | ÉCHELLE INTÉRIEURE |
INSIDE LADDER | SCALA INTERNA



ESCALERA EXTERIOR | ÉCHELLE EXTÉRIEURE |
OUTSIDE LADDER | SCALA ESTERNA



ESTRUCTURA | STRUCTURE |
STRUCTURE | STRUTTURA



ACCESORIOS | ACCESSORIES |
ACCESSOIRES | ACCESSORI
MADERA | WOOD | BOIS | LEGNO



INSTALACIÓN | INSTALLATION | INSTALLAZIONE



MANGO

MARBELLA

KPBR620

790096
LDD: 790096D

8412081273266

3605217900968
LDD: 8412081003382

6,18 x 3,20 x H. 1,30 m

4,27 x 2,77 x H. 1,19 m

5,68 x 2,73 x H. 1,27 m

3,79 x 2,29 x H. 1,16 m

18,1 m³

9 m³

1,17 m

1,06 m

Pino silvestre francés y autoclave clase IV · Pine boards originating in France, with a class IV autoclave · Pin sylvestre origine France autoclave classe IV · pino silvestre francese con trattamento in autoclave classe IV
Certificado · Certificata · Certifié · Certificato PEFC

46 mm

46 mm

✓

✓

Double
14,5 cm x 2 = 29 cm

Double
14,5 cm x 2 = 29 cm

2,8 cm

2,8 cm

✓

✓

60/100

75/100

FILTRO DE ARENA · SAND FILTER · FILTRATION À SABLE · FILTRO A SABBIA

6 m³/h

4 m³/h

Espeor · Thickness · Épaisseur · Dimensione: 200 g/m²

✓

✓

✓

✓

ACERO INOXIDABLE · STAINLESS STEEL · ACIER INOXYDABLE · ACCIAIO INOX

MADERA · WOOD · BOIS · LEGNO



SISTEMA DE OMEGAS · OMEGA SYSTEM · RENFORTS ENTERRÉS · SISTEMA OMEGA

Losa de hormigón opcional · Optional concrete slab · Dalle béton facultative · Basamento di calcestruzzo opzionale

718 x 421 x H 15 cm
4,55 m³

528 x 378 x H 15 cm
3,00 m³

L 200 x I 80 x H 78 cm - 285 kg
L 405 x I 111 x H 54 cm - 1053 kg

L 120 x I 80 x H 100 cm - 252 kg
L 405 x I 111 x H 40 cm - 700 kg

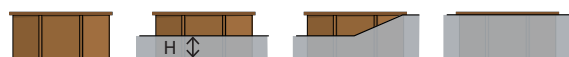

wooden pools CARRA · LEMON · CITY

H. 1,19 - 0,68 m

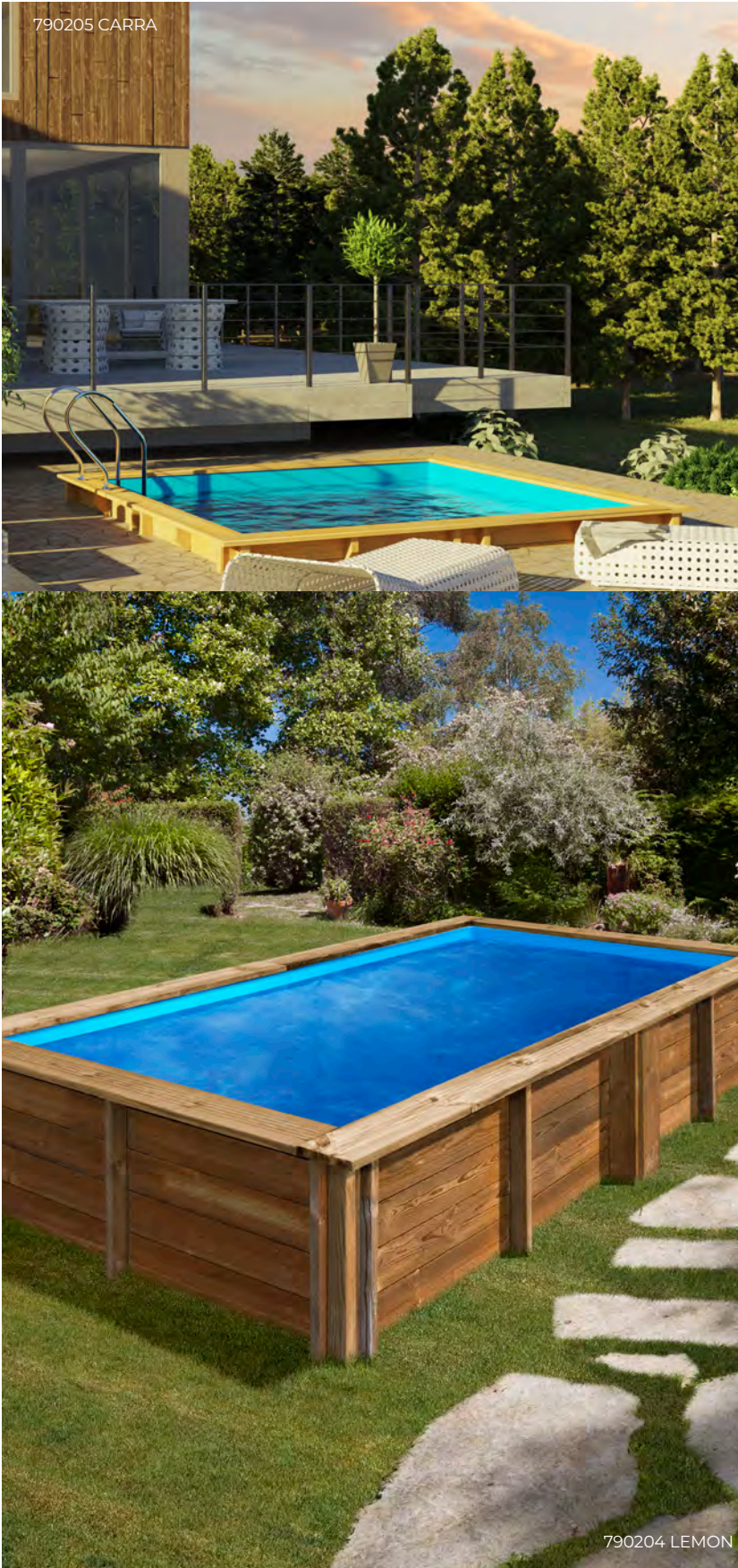

REFERENCIA | RÉFÉRENCE |
REFERENCE | RIFERIMENTO



CÓDIGO | GENCOD |
EAN CODE | CODICE A BARRE



EXTERIORES | EXTÉRIEURES |
OUTSIDE | ESTERNO



INTERIORES | INTÉRIEURES |
INSIDE | INTERNI



VOLUMEN DE AGUA | VOLUME D'EAU | WATER
VOLUME | VOLUME DI ACQUA



LINEA DE AGUA | LIGNE D'EAU |
WATER LINE | LINEA DELL'ACQUA



MADERA | WOOD | BOIS | LEGNO



ESPESOR MADERA | ÉPAISEUR MADRIER |
WOOD THICKNESS | DIMENSIONE



MACHIHEMBADO | TONGUE AND GROOVE |
ASSEMBLAGE RAINURES LANGUETTES | INCASTRO

PLAYAS | MARGELLES | EDGES | BORDI



ANCHO | WIDTH | LARGEUR | LARGHEZZA

ESPESOR | THICKNESS | ÉPAISEUR |
DIMENSIONE



EMBELLECEDORES METÁLICOS | METAL COVERS
CACHES ANGLES INOX | PROTEZIONE METALLICO



LINER



FILTRACIÓN | FILTRATION | FILTRO



PROTECTOR | FEUTRE | PROTECTOR | PROTEZIONE

FONDO | FLOOR | FOND



PARED | PAROI | WALL | PARETE



ESCALERA INTERIOR | ÉCHELLE INTÉRIEURE |
INSIDE LADDER | SCALA INTERNA



ESCALERA EXTERIOR | ÉCHELLE EXTÉRIEURE |
OUTSIDE LADDER | SCALA ESTERNA



ESTRUCTURA | STRUCTURE |
STRUCTURE | STRUTTURA



TERRENO | TERRAIN | LAND | TERRENO







ACCESORIOS | ACCESSORIES |
ACCESSOIRES | ACCESSORI
MADERA | WOOD | BOIS | LEGNO

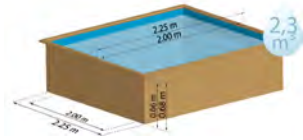
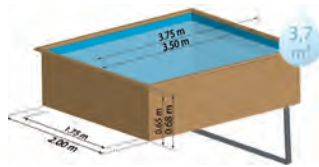

INSTALACIÓN | INSTALLATION | INSTALLAZIONE



CARRA	LEMON	CITY
790205 LDD: 790205D	 790204 LDD: 790204D	790000 LDD: 790000D
3605217902054 LDD: 3605217902184	3605217902047 LDD: 3605217902177	3605217900005 LDD: 8412081003474
3,05 x 3,05 x H. 1,19 m	3,75 x 2,00 x H. 0,68 m	2,25 x 2,25 x H. 0,68 m
2,73 x 2,73 x H. 1,16 m	3,50 x 1,75 x H. 0,65 m	2,00 x 2,00 x H. 0,65 m
7,7 m ³	3,7 m ³	2,3 m ³
1,06 m	0,6 m	0,6 m
Pino silvestre francés y autoclave clase IV · Pine boards originating in France, with a class IV autoclave · Pin sylvestre origine France autoclave classe IV · pino silvestre francese con trattamento in autoclave classe IV Certificado · Certificate · Certifié · Certificato PEFC		
46 mm	36 mm	36 mm
✓	PANELES - BOARDS - PANNEAUX - PANNELLI	
Simple	Simple	Simple
19 cm	19 cm	14,5 cm
2,8 cm	2,8 cm	2,8 cm
-	-	-
60/100	50/100	50/100
FILTRO DE ARENA · SAND FILTER · FILTRATION À SABLE · FILTRO A SABBIA	FILTRO DE CARTUCHO · CARTRIDGE FILTER · EPURATEUR À CARTOUCHE · FILTRO A CARTUCCIA	
4 m ³ /h	2 m ³ /h	
Espesor · Thickness · Épaisseur · Dimensione: 200 g/m ²	Espesor · Thickness · Épaisseur · Dimensione: 100 g/m ²	
✓	✓	✓
✓	-	-
ACERO INOXIDABLE · STAINLESS STEEL · ACIER INOXYDABLE · ACCIAIO INOX	-	-
MADERA · WOOD · BOIS · LEGNO	-	-
 CUÑA METÁLICA · WEDGE LE SABOT · CUNEIO METALLICO	 OMEGA SYSTEM	 -
Losa de hormigón obligatorio · Obligatory concrete slab · Dalle béton Obligatoire · Basamento di calcestruzzo obbligatorio	Losa de hormigón opcional · Optional concrete slab · Dalle béton facultative · Basamento di calcestruzzo opzionale	
351 x 351 x H 15 cm 1,86 m ³	409 x 324 x H 15 cm 1,99 m ³	259 x 259 x H 10 0,67 m ³
L 120 x l 80 x H 78 cm - 160 kg L 305 x l 111 x H 45 cm - 590 kg	BOX: L 60 x l 40 x H 80 cm - 40 kg L 180 x l 65 x H 59 cm - 300 kg	BOX: L 47 x l 30 x H 70 cm - 15 kg L 200 x l 120 x H 60 cm - 188 kg
		

wooden pools ORANGE · VERMELA · AVOCADO · SAFRAN

H. 1,46 - 1,31 - 1,33 m



790203 AVOCADO



790089 SAFRAN

REFERENCIA | RÉFÉRENCE |
REFERENCE | RIFERIMENTO



CÓDIGO | GENCOD |
EAN CODE | CODICE A BARRE



EXTERIORES | EXTÉRIEURES |
OUTSIDE | ESTERNO



INTERIORES | INTÉRIEURES |
INSIDE | INTERNI



VOLUMEN DE AGUA | VOLUME D'EAU | WATER
VOLUME | VOLUME DI ACQUA



LINEA DE AGUA | LIGNE D'EAU |
WATER LINE | LINEA DELL'ACQUA



MADERA | WOOD | BOIS | LEGNO



ESPESOR MADERA | ÉPAISSEUR MADRIER |
WOOD THICKNESS | DIMENSIONE



MACHIHEMBRADO | TONGUE AND GROOVE |
ASSEMBLAGE RAINURES LANGUETTES | INCASTRO



PLAYAS | MARGELLES | EDGES | BORDI

ANCHO | WIDTH | LARGEUR | LARGHEZZA

ESPESOR | THICKNESS | ÉPAISSEUR |
DIMENSIONE



EMBELLECEDORES METÁLICOS | METAL COVERS
CACHES ANGLES INOX | PROTEZIONE METALLICO



LINER



FILTRACIÓN | FILTRATION | FILTRO



PROTECTOR | FEUTRE | PROTECTOR | PROTEZIONE

FONDO | FLOOR | FOND



PARED | PAROI | WALL | PARETE



ESCALERA INTERIOR | ÉCHELLE INTÉRIEURE |
INSIDE LADDER | SCALA INTERNA



ESCALERA EXTERIOR | ÉCHELLE EXTÉRIEURE |
OUTSIDE LADDER | SCALA ESTERNA



ESTRUCTURA | STRUCTURE |
STRUCTURE | STRUTTURA



TERRENO | TERRAIN | LAND | TERRENO



ACCESORIOS | ACCESSORIES |
PALET ACCESSOIRES | ACCESSORI
MADERA | WOOD | BOIS | LEGNO



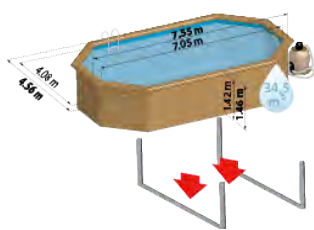

INSTALACIÓN | INSTALLATION | INSTALLAZIONE



NEW
2021



ORANGE	VERMELA	AVOCADO	SAFRAN
800007 LDD: 800007D	790098 LDD: 790098D	790203 LDD: 790203D	790089 LDD: 790089D
8412081313313 LDD: 8412081314457	3605217900982 LDD: 8412081003498	3605217902030 LDD: 3605217902146	3605217900890 LDD: 8412081003313
7,55 x 4,56 x H. 1,46 m	6,72 x 4,72 x 1,46 m	6,56 x 4,56 x H. 1,31 m	6,37 x 4,12 x H. 1,33 m
7,05 x 4,08 x H. 1,42 m	6,23 x 4,23 x 1,42 m	6,08 x 4,08 x H. 1,27 m	5,90 x 3,65 x H. 1,30 m
34,5 m ³	31 m ³	24,7 m ³	23 m ³
1,36 m	1,36 m	1,17 m	1,20 m
Pino silvestre francés y autoclave clase IV · Pine boards originating in France, with a class IV autoclave · Pin sylvestre origine France autoclave classe IV · pino silvetre francese con trattamento in autoclave classe IV Certificado · Certificate · Certifié · Certificato PEFC			
46 mm	46 mm	46 mm	46 mm
-	✓	-	✓
Double 14,5 cm x 2 = 29 cm	Double 14,5 cm x 2 = 29 cm	Double 14,5 cm x 2 = 29 cm	Double 14,5 cm x 2 = 29 cm
2,8 cm	2,8 cm	2,8 cm	2,8 cm
✓	✓	✓	
75/100	75/100	75/100	75/100
FILTRO DE ARENA · SAND FILTER · FILTRATION À SABLE · FILTRO A SABBIA			
10 m ³ /h	8 m ³ /h	8 m ³ /h	8 m ³ /h
Espesor · Thickness · Épaisseur · Dimensione: 200 g/m ²			
✓	✓	✓	✓
✓	✓	✓	✓
ACERO INOXIDABLE · STAINLESS STEEL · ACIER INOXYDABLE · ACCIAIO INOX			
MADERA · WOOD · BOIS · LEGNO			
 IPE SYSTEM	 CUÑA METÁLICA · WEDGE · SABOT · CUNEO METALLICO		
Losa de hormigón obligatorio · Obligatory concrete slab · Dalle béton Obligatoire · Basamento di calcestruzzo obbligatorio			
764 x 497 x H 17 cm 6,46 m ³	682 x 512 x H 17 cm 5,94 m ³	666 x 486 x H 15 4,87 m ³	646 x 442 x H 15 4,29 m ³
L 200 x l 80 x H 100 cm - 410 kg L 405 x l 102 x H 75 cm - 1267 kg	L 200 x l 80 x H 100 cm - 357 kg L 405 x l 111 x H 59 cm - 1250 kg	L 120 x l 80 x H 100 cm - 250 kg L 400 x l 114 x H 65 cm - 1084 kg	L 120 x l 80 x H 100 cm - 270 kg L 405 x l 111 x H 57 cm - 1040 kg
			

wooden pools CAMOMILLE · CANELLE · GRENADE

H. 1,27 - 1,19 m



790087 CANELLE



790086 GRENADE

REFERENCIA | RÉFÉRENCE |
REFERENCE | RIFERIMENTO



CÓDIGO | GENCOD |
EAN CODE | CODICE A BARRE



EXTERIORES | EXTÉRIEURES |
OUTSIDE | ESTERNO



INTERIORES | INTÉRIEURES |
INSIDE | INTERNI



VOLUMEN DE AGUA | VOLUME D'EAU | WATER
VOLUME | VOLUME DI ACQUA



LINEA DE AGUA | LIGNE D'EAU |
WATER LINE | LINEA DELL'ACQUA



MADERA | WOOD | BOIS | LEGNO



ESPESOR MADERA | ÉPAISEUR MADRIER |
WOOD THICKNESS | DIMENSIONE



MACHIHEMBRADO | TONGUE AND GROOVE |
ASSEMBLAGE RAINURES LANGUETTES | INCASTRO

PLAYAS | MARGELLES | EDGES | BORDI



ANCHO | WIDTH | LARGEUR | LARGHEZZA

ESPESOR | THICKNESS | ÉPAISEUR |
DIMENSIONE



EMBELLECEDORES METÁLICOS | METAL COVERS
CACHES ANGLES INOX | PROTEZIONE METALLICO



LINER



FILTRACIÓN | FILTRATION | FILTRO

PROTECTOR | FEUTRE | PROTECTOR | PROTEZIONE



FONDO | FLOOR | FOND



PARED | PARI | WALL | PARETE

ESCALERA INTERIOR | ÉCHELLE INTÉRIEURE |
INSIDE LADDER | SCALA INTERNA



ESCALERA EXTERIOR | ÉCHELLE EXTÉRIEURE |
OUTSIDE LADDER | SCALA ESTERNA



ESTRUCTURA | STRUCTURE |
STRUCTURE | STRUTTURA



TERRENO | TERRAIN | LAND | TERRENO



ACCESORIOS | ACCESSORIES |
PALET ACCESSOIRES | ACCESSORI
MADERA | WOOD | BOIS | LEGNO



INSTALACIÓN | INSTALLATION | INSTALLAZIONE

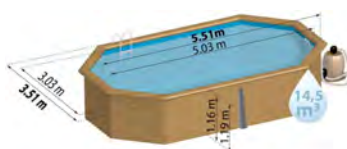

CAMOMILLE	CANELLE	GRENADE
790202	790087 LDD: 790087D	790086 LDD: 790086D
3605217902023	3605217900876 LDD: 8412081003290	3605217900869 LDD: 8412081003283
6,20 x 3,95 x H. 1,27 m	5,51 x 3,51 x H. 1,19 m	4,36 x 3,36 x H. 1,19 m
5,73 x 3,48 x H. 1,24 m	5,03 x 3,03 x H. 1,16 m	4,03 x 3,03 x H. 1,16 m
20,8 m ³	14,5 m ³	11,2 m ³
1,14 m	1,06 m	1,06 m
Pino silvestre francés y autoclave clase IV · Pine boards originating in France, with a class IV autoclave · Pin sylvestre origine France autoclave classe IV · pino silvestre francese con trattamento in autoclave classe IV Certificado · Certificate · Certifié · Certificato PEFC		
46 mm	46 mm	46 mm
-	✓	✓
Double 14,5 cm x 2 = 29 cm	Double 14,5 cm x 2 = 29 cm	Simple 19 cm
2,8 cm	2,8 cm	2,8 cm
✓	✓	✓
60/100	60/100	60/100
FILTRO DE ARENA · SAND FILTER · FILTRATION À SABLE · FILTRO A SABBIA		
6 m ³ /h	6 m ³ /h	4 m ³ /h
Espesor · Thickness · Épaisseur · Dimensione: 200 g/m ²		
✓	✓	✓
✓	✓	✓
ACERO INOXIDABLE · STAINLESS STEEL · ACIER INOXYDABLE · ACCIAIO INOX		
MADERA · WOOD · BOIS · LEGNO		
CUÑA METÁLICA · WEDGE · SABOT · CUNEO METALLICO		
Losa de hormigón obligatorio · Obligatory concrete slab · Dalle béton Obligatoire · Basamento di calcestruzzo obbligatorio		
632 x 427 x H 15 cm 4,04 m ³	561 x 381 x H 15 cm 3,21 m ³	461 x 381 x H 15 cm 2,64 m ³
L 120 x l 80 x H 85 cm - 200 kg L 400 x l 114 x H 53 cm 950 kg	L 130 x l 80 x H 78 cm - 138 kg L 400 x l 114 x H 65 cm - 800 kg	L 120 x l 80 x H 78 cm - 140 kg L 400 x l 120 x H 57 cm - 620 kg

wooden pools **MACADAMIA · BAMBU**

H. 1,30 m



KPB0C535 BAMBU



KPB0C632 MACADAMIA

REFERENCIA | RÉFÉRENCE |
REFERENCE | RIFERIMENTO



CÓDIGO | GENCODE |
EAN CODE | CODICE A BARRE



EXTERIORES | EXTÉRIEURES |
OUTSIDE | ESTERNO



INTERIORES | INTÉRIEURES |
INSIDE | INTERNI



VOLUMEN DE AGUA | VOLUME D'EAU | WATER
VOLUME | VOLUME DI ACQUA



LINEA DE AGUA | LIGNE D'EAU |
WATER LINE | LINEA DELL'ACQUA



MADERA | WOOD | BOIS | LEGNO



ESPESOR MADERA | ÉPAISSEUR MADRIER |
WOOD THICKNESS | DIMENSIONE



MACHIHEMBRADO | TONGUE AND GROOVE |
ASSEMBLAGE RAINURES LANGUETTES | INCASTRO



PLAYAS | MARGELLES | EDGES | BORDI

ANCHO | WIDTH | LARGEUR | LARGHEZZA

ESPESOR | THICKNESS | ÉPAISSEUR |
DIMENSIONE



EMBELLECEDORES METÁLICOS | METAL COVERS
CACHES ANGLES INOX | PROTEZIONE METALLICO



LINER



FILTRACIÓN | FILTRATION | FILTRO



PROTECTOR | FEUTRE | PROTECTOR | PROTEZIONE

FONDO | FLOOR | FOND



PARED | PAROI | WALL | PARETE



ESCALERA INTERIOR | ÉCHELLE INTÉRIEURE |
INSIDE LADDER | SCALA INTERNA



ESCALERA EXTERIOR | ÉCHELLE EXTÉRIEURE |
OUTSIDE LADDER | SCALA ESTERNA



ESTRUCTURA | STRUCTURE |
STRUCTURE | STRUTTURA



TERRENO | TERRAIN | LAND | TERRENO



ACCESORIOS | ACCESSORIES |
PALET ACCESSOIRES | ACCESSORI
MADERA | WOOD | BOIS | LEGNO



INSTALACIÓN | INSTALLATION | INSTALLAZIONE

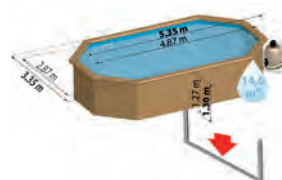
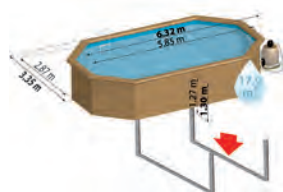

MACADAMIA

BAMBU

🇪🇸 KPBOC632

🇪🇸🇮🇹 KPBOC535

8412081273242

8412081273235

6,32 x 3,35 x H. 1,30 m

5,35 x 3,35 x H. 1,30 m

5,85 x 2,87 x H. 1,27 m

4,87 x 2,87x H. 1,27 m

17,9 m³

14,6 m³

1,17 m

1,17 m

Pino silvestre francés y autoclave clase IV · Pine boards originating in France, with a class IV autoclave · Pin sylvestre origine France autoclave classe IV · pino silvestre francese con trattamento in autoclave classe IV
Certificado · Certificate · Certifié · Certificato PEFC

46 mm

46 mm



Double

Double

14,5 cm x 2 = 29 cm

14,5 cm x 2 = 29 cm

2,8 cm

2,8 cm



60/100

60/100

FILTRO DE ARENA · SAND FILTER · FILTRATION À SABLE · FILTRO A SABBIA

6 m³/h

6 m³/h

Espesor · Thickness · Épaisseur · Dimensione: 200 g/m²



ACERO INOXIDABLE · STAINLESS STEEL · ACIER INOXYDABLE · ACCIAIO INOX

MADERA · WOOD · BOIS · LEGNO



SISTEMA DE OMEGAS · OMEGA SYSTEM · RENFORTS ENTERRÉS · SISTEMA OMEGA

Losa de hormigón opcional · Optional concrete slab · Dalle béton facultative · Basamento di calcestruzzo opzionale

642 x 435 x H 15 cm
4,20 m³

545 x 435 x H 15 cm
3,56 m³

L 200 x l 80 x H 78 cm - 250 kg
L 405 x l 111 x H 54 cm - 990 kg

L 200 x l 80 x H 78 cm - 167 kg
L 355 x l 111 x H 53 cm - 820 kg

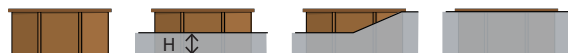

wooden pools VIOLETTE 2 · ANANAS · VANILLE 2 · LILI 2

H. 1,27 m - 1,17 m - 1,19 m - 1,07 m



790210 ANANAS



800003 VIOLETTE 2

REFERENCIA | RÉFÉRENCE |
REFERENCE | RIFERIMENTO



CÓDIGO | GENCOD |
EAN CODE | CODICE A BARRE



EXTERIORES | EXTÉRIEURES |
OUTSIDE | ESTERNO



INTERIORES | INTÉRIEURES |
INSIDE | INTERNI



VOLUMEN DE AGUA | VOLUME D'EAU | WATER
VOLUME | VOLUME DI ACQUA



LINEA DE AGUA | LIGNE D'EAU |
WATER LINE | LINEA DELL'ACQUA



MADERA | WOOD | BOIS | LEGNO



ESPESOR MADERA | ÉPAISSEUR MADRIER |
WOOD THICKNESS | DIMENSIONE



MACHIHEMRADO | TONGUE AND GROOVE |
ASSEMBLAGE RAINURES LANGUETTES | INCASTRO

PLAYAS | MARGELLES | EDGES | BORDI



ANCHO | WIDTH | LARGEUR | LARGHEZZA

ESPESOR | THICKNESS | ÉPAISSEUR |
DIMENSIONE



EMBELLECEDORES METÁLICOS | METAL COVERS
CACHES ANGLES INOX | PROTEZIONE METALLICO



LINER



FILTRACIÓN | FILTRATION | FILTRO



PROTECTOR | FEUTRE | PROTECTOR | PROTEZIONE

FONDO | FLOOR | FOND



PARED | PARI | WALL | PARETE



ESCALERA INTERIOR | ÉCHELLE INTÉRIEURE |
INSIDE LADDER | SCALA INTERNA



ESCALERA EXTERIOR | ÉCHELLE EXTÉRIEURE |
OUTSIDE LADDER | SCALA ESTERNA



ESTRUCTURA | STRUCTURE |
STRUCTURE | STRUTTURA



TERRENO | TERRAIN | LAND | TERRENO



ACCESORIOS | ACCESSORIES |
ACCESSOIRES | ACCESSORI
MADERA | WOOD | BOIS | LEGNO



INSTALACIÓN | INSTALLATION | INSTALLAZIONE

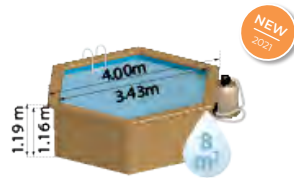
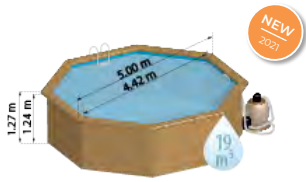

VIOLETTE 2		ANANAS		VANILLE 2		LILI 2	
800003 LDD: 800003D		790210 LDD: 790210D		800002 LDD: 800002D		800008 LDD: 800008D	
8412081313283 LDD: 8412081314440		3605217902108 LDD: 3605217902122		8412081313252 LDD: 8412081314433		8412081313221 LDD: 8412081314426	
Ø 5,00 x H. 1,27 m		Ø 4,28 x H. 1,17 m		Ø 4,00 x H. 1,19 m		Ø 2,80 x H. 1,07 m	
Ø 4,42 x H. 1,24 m		Ø 3,76 x H. 1,14 m		Ø 3,43 x H. 1,16 m		Ø 2,42 x H. 1,04 m	
15,5 m ³		10,5 m ³		8 m ³		3,6 m ³	
1,17 m		1,07 m		1,09 m		0,97 m	
Pino silvestre francés y autoclave clase IV · Pine boards originating in France, with a class IV autoclave · Pin sylvestre origine France autoclave classe IV · pino silvestre francese con trattamento in autoclave classe IV Certificado · Certificate · Certifié · Certificato PEFC							
46 mm		46 mm		46 mm		46 mm	
-		-		-		-	
Double 14,5 cm x 2 = 29 cm		Double 14,5 cm x 2 = 29 cm		Double 14,5 cm x 2 = 29 cm		Simple 19 cm	
2,8 cm		2,8 cm		2,8 cm		2,8 cm	
✓		✓		✓		-	
75/100		75/100		50/100		50/100	
FILTRO DE ARENA · SAND FILTER · FILTRATION À SABLE · FILTRO A SABBIA						AQUALOON	
6 m ³ /h		6 m ³ /h		4 m ³ /h		4 m ³ /h	
Espesor · Thickness · Épaisseur · Dimensione: 200 g/m ²							
✓		✓		✓		100 g/m ²	
✓		✓		✓		-	
ACERO INOXIDABLE · STAINLESS STEEL · ACIER INOXYDABLE · ACCIAIO INOX						Escalera seguridad plataforma Safety ladder platform Échelle sécurité plateforme Scala di sicurezza piattaforma	
MADERA · WOOD · BOIS · LEGNO							
-							
Losas de hormigón opcional · Optional concrete slab · Dalle béton facultative · Basamento di calcestruzzo opzionale							
467 x 467 x H 10 cm 2,18 m ³		407 x 407 x H 10 cm 1,65 m ³		356 x 356 x H 10 cm 1,27 m ³		268 x 268 x H 10 cm 0,72 m ³	
L 120 x l 80 x H 78 cm - 120 kg L 205 x l 111 x H 76 cm - 770 kg		L 120 x l 80 x H 78 cm - 115 kg L 180 x l 105 x H 75 cm - 651 kg		L 120 x l 80 x H 78 cm - 95 kg L 205 x l 111 x H 59 cm - 544 kg		L 120 x l 80 x H 78 cm - 54 kg L 155 x l 102 x H 55 cm - 360 kg	

Avantgarde

POOLS

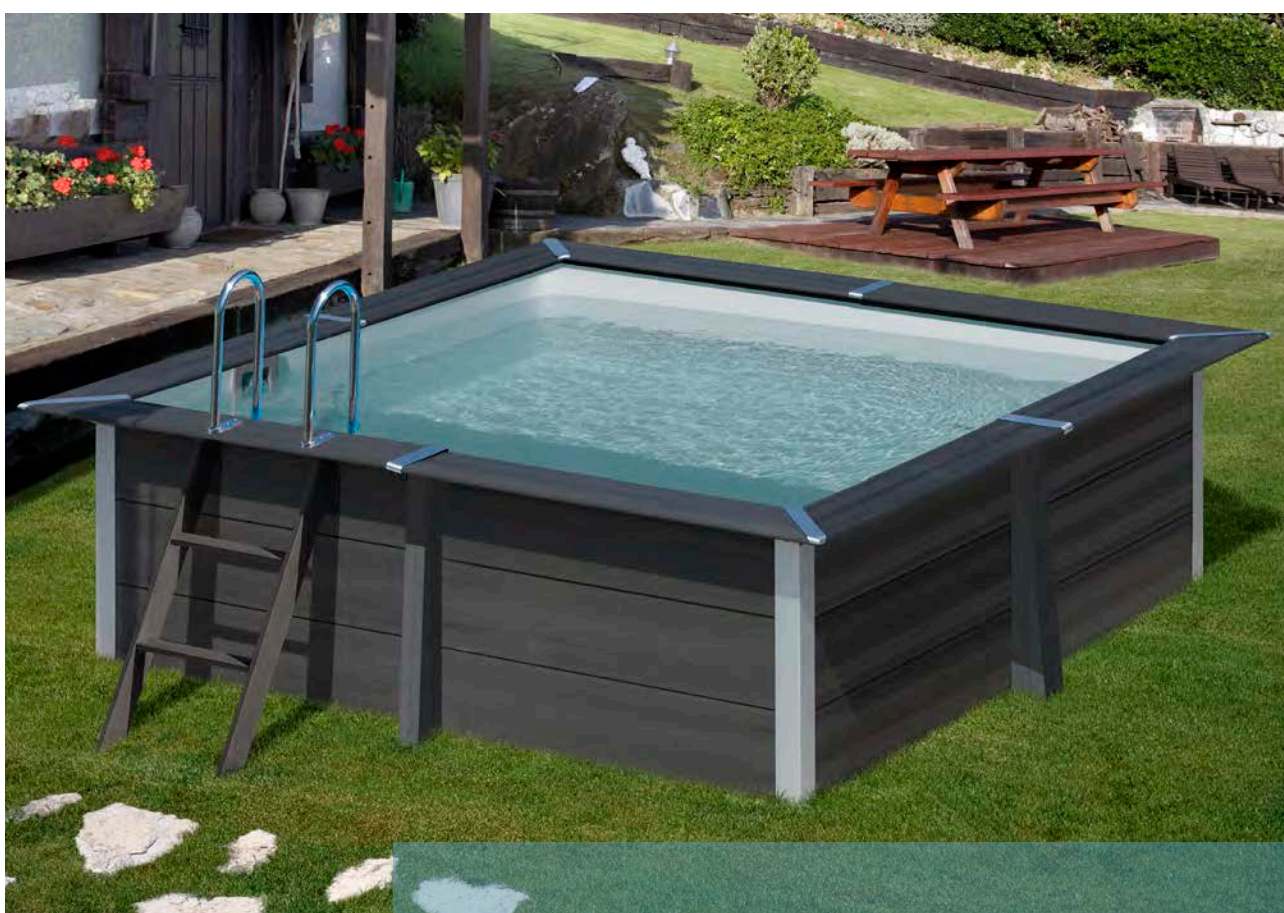



PISCINAS DE COMPOSITE

LINER: Tratamiento Anti-ultravioleta que retrasa el envejecimiento del P.V.C.

COMPOSITE: Las piscinas de composite están fabricadas de un nuevo material mezcla de madera (harina de madera) y polímeros.

COMPOSITE POOLS

LINER: Anti-ultraviolet treatment to slow down P.V.C aging.

COMPOSITE: Composite pools are made of a new material composed of wood (wood flour) and polymers.

PISCINES COMPOSITE

LINER: Traitement anti-ultraviolets contre le vieillissement du P.V.C.

COMPOSITE: Les piscines "composite" sont fabriquées avec un nouveau matériau composé d'un mélange de bois (farine de bois) et de polymères.

PISCINA IN COMPOSITE

LINER: Trattamento Anti-ultravioletti - Ritarda l'invecchiamento del P.V.C.

COMPOSITE: Le piscine in composite vengono prodotte con un nuovo materiale composto da una miscela di legno (farina di legno) e polimeri.



Resina plástica
Plastic resin
Résine plastique
Resina plastica

+



Serrín
Sawdust
Farine de bois
Segatura

+



Pigmento
Pigments
Pigments
Pigmenti

+



Aditivos con carga mineral
Mineral additives
Additifs Charge minérale
Additivi con carica minerale

=



DESIGNED &
ASSEMBLED
IN EU

composite pool



KPCOR60



EAN 13

NEW 2021

KPCOR60L	606x326 cm	124 cm	17.875 l	1220 kg	1/170x130	6m ³ /h	√	√	√	8 412081 313092	
KPCOR60	606x326 cm	124 cm	17.875 l	1220 kg	1/170x130	6m ³ /h	√	√	-	8 412081 273686	
KPCOR46	466x326 cm	124 cm	13.400 l	1000 kg	1/170x130	6m ³ /h	√	√	-	8 412081 304878	
KPCOR28	326x326 cm	96 cm	6.600 l	900 kg	1/170x130	4m ³ /h	√	√	-	8 412081 302683	
KPCOR2814	326x186 cm	96 cm	3.300 l	450 kg	1/170x130	4m ³ /h	√	√	-	8 412081 304953	

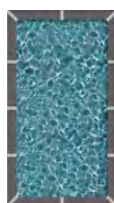
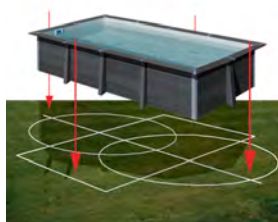

MEDIDA PISCINA
POOL SIZE
DIMENSIONS PISCINE
MISURA PISCINA

ESPACIO NECESARIO
NECESSARY SPACE
ESPACE NECESSAIRE
SPAZIO NECESSARIO

KPCOR60	606x326 cm	806x526 cm
KPCOR46	466x326 cm	666x526 cm
KPCOR28	326x326 cm	526x526 cm
KPCOR2814	326x186 cm	526x386 cm

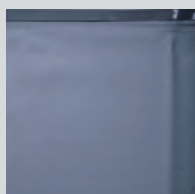

Liner PVC gris 60/100
PVC grey liner 60/100
Liner PVC gris 60/100
Liner PVC grigio 60/100

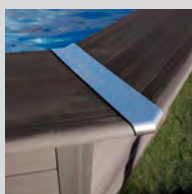

Embellecedores y perfilera de aluminio
Aluminium profiles and trims
Protections et margelles en aluminium
Profili in alluminio

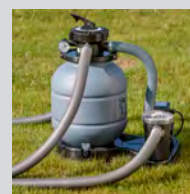

Depuradora arena
(Caudal grupo 6/4 m³/h)
Sand filter
(Flow group 6/4 m³/h)
Filtre à sable
(Débit groupe 6/4 m³/h)
Filtro a sabbia
(Portata gruppo 6/4 m³/h)



La cuña metálica se fija sobre la losa de cemento. Así, es obligatorio realizar la losa, de 15cm de espesor mínimo, previamente al montaje de la piscina.

The wedge is fixed over the concrete slab. In such a way, it is mandatory to make the slab, of 15cm minimum, beforehand to the assembly of the pool.

Le sabot vient se fixer sur la dalle en béton. Il est donc impératif de réaliser une dalle de 15 cm minimum avant le montage du bassin.

Il cuneo metallico si fissa sopra il massetto di cemento. Quindi è obbligatorio realizzare il massetto dello spessore minimo di 15cm prima del montaggio della piscina.

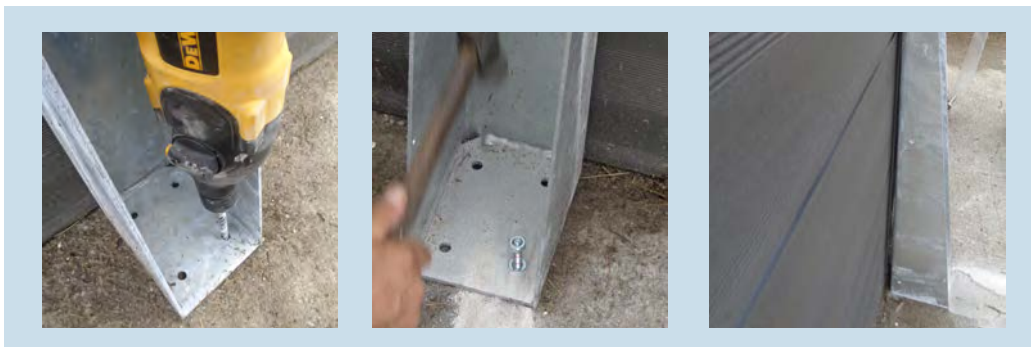

Cuña metálica Metallic wedge Sabots Cuneo metallico



White led projector
Preycor led blanco
Projecteur led blanc
Proiettore a led bianco



Escalera: Composite /
acero inoxidable
Ladder: Composite /
stainless steel
Échelle: Composite /
acier inoxydable
Scale: Composite /
acciaio inox

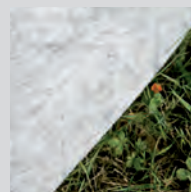

Manta protectora
(Poliéster)
Bottom protective-
blanket (Polyester)
Tapis de sol en feutre
(Polyester)
Telo di protezione
(Poliestere)

composite pool



Vigas enterradas de 15x15 cm que hace innecesarios los postes exteriores, obteniendo mejor aprovechamiento del jardín.

* KPCOV6650: sistema de vigas metálicas (IPE).

15x15cm buried steel beam makes unnecessary the outer posts, optimizing the use of the garden area.

* KPCOV6650: Buried steel beam (IPE).



Poteaux en acier à enterrer de 15x15 cm évitant des renforts apparents extérieurs, pour mieux profiter de l'espace du jardin.

* KPCOV6650: berceaux métalliques (IPE).

Barra di acciaio interrata da 15x15 cm che non rende necessario l'utilizzo delle barre laterali; permette di poter sfruttare al meglio gli spazi del proprio giardino.

* KPCOV6650: barra di acciaio (IPE).

KPCOV52



EAN 13

	Dimensions	Height	Capacity	Weight	Box	Pump	Ladder	Filter	Ring	EAN 13
KPCOV80	804x386 cm	124 cm	27.000 l	1450 kg	1/170x150	6m³/h	✓	✓	-	8 412081 268804
NEW 2021 KPCOV6650	664x386 cm	154 cm	27.500 l	1600 kg	1/170x150	8m³/h	✓	✓	-	8 412081 312705
NEW 2021 KPCOV66L	664x386 cm	124 cm	21.500 l	1220 kg	1/170x150	6m³/h	✓	✓	✓	8 412081 313108
KPCOV66	664x386 cm	124 cm	21.500 l	1220 kg	1/170x150	6m³/h	✓	✓	-	8 412081 268798
KPCOV52	524x386 cm	124 cm	16.210 l	960 kg	1/170x130	6m³/h	✓	✓	-	8 412081 268781

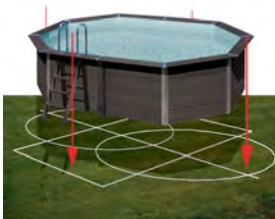

MEDIDA PISCINA
POOL SIZE
DIMENSIONS PISCINA
MISURA PISCINA

ESPACIO NECESARIO
NECESSARY SPACE
ESPACE NECESSAIRE
SPAZIO NECESSARIO

Model	Pool Size	Necessary Space
KPCOV80	804x386 cm	844x506 cm
KPCOV66 KPCOV6650 KPCOV66	664x386 cm	704x506 cm
KPCOV52	524x386 cm	564x506 cm

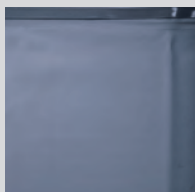

Liner PVC gris 60/100
PVC grey liner 60/100
Liner PVC gris 60/100
Liner PVC grigio 60/100

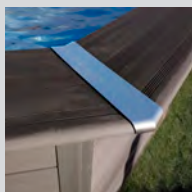

Embellecedores y periferia de aluminio
Aluminium profiles and trims
Protections et margelles en aluminium
Profili in alluminio

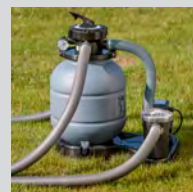

Depuradora arena
(Caudal grupo 6/4 m³/h)
Sand filter
(Flow group 6/4 m³/h)
Filtre à sable
(Débit groupe 6/4 m³/h)
Filtro a sabbia
(Portata gruppo 6/4 m³/h)



KPCO41



EAN 13

KPCO41

Ø 410 cm

124 cm

11.000 l

705 kg

1/170x130

4m³/h

✓

✓

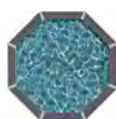

MEDIDA PISCINA
POOL SIZE
DIMENSIONS PISCINE
MISURA PISCINA

ESPACIO NECESARIO
NECESSARY SPACE
ESPACE NECESSAIRE
SPAZIO NECESSARIO

KPCO41

Ø 410cm

450x450 cm



White led projector
Preycor led blanco
Projecteur led blanc
Proiettore a led bianco



Escala: Composite /
acero inoxidable
Ladder: Composite /
stainless steel
Échelle: Composite /
acier inoxydable
Scale: Composite /
acciaio inox

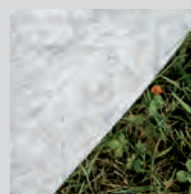

Manta protectora
(Poliéster)
Bottom protective-
blanket (Polyester)
Tapis de sol en feutre
(Polyester)
Telo di protezione
(Poliestere)

dream pool





PISCINA DESMONTABLE DE PARED DE ACERO

LINER: Tratamiento Anti - Ultravioleta que retrasa el envejecimiento del P.V.C.

CHAPA: laminada en frío con tratamiento de galvanización, fosfatación, imprimación y lacado.

Perfilación vertical de la misma para la obtención de una mayor resistencia.

Troquelada para skimmer y válvula de retorno del agua.

PIEZAS ESTRUCTURALES: De acero.

PISCINES HORS SOL AVEC PAROIS EN ACIER

LINER: Traitement anti-ultraviolets contre le vieillissement du P.V.C.

TÔLE: Tôle laminée à froid et traitée par galvanisation, phosphatage, couche d'apprêt et laquage.

Profilés verticaux pour une meilleure résistance.

Découpage pour le skimmer et la buse de refoulement.

PIÈCES STRUCTURELLES: Métalliques

STEEL WALL POOL

LINER: Anti-ultraviolet treatment to slow down P.V.C aging.

PLATE: Galvanized, phosphatized, primed and lacquered cold-rolled plate .

Vertical sectioning for an increased strength . Die cut for skimmer and water return valve openings.

STRUCTURAL PARTS: Steel

PISCINE FUORI TERRA CON PARETI IN ACCIAIO

LINER: Trattamento Anti-ultravioletti - Ritarda l'invecchiamento del P.V.C.

PANNELLO: Laminata a freddo con trattamento di galvanizzazione, fosfatazione e preparazione.

Preparazione verticale per ottenere una maggiore resistenza.

Stampigliatura per Skimmer e valvola di ritorno dell'acqua.

PEZZI STRUTTURALI: Acciaio.



DESIGNED
MACHINED &
ASSEMBLED
IN EU

dream pool

serie **ISLANDIA**

NEW
2021

KITPROV7388N



EAN 13

KITPROV7388N	730x375 cm	132 cm	28.217 l	348 kg	1/120x80	6m ³ /h	√	√	15	12	8 4 12081 313665
KITPROV6188N	610x375 cm	132 cm	23.281 l	279 kg	1/90x80	6m ³ /h	√	√	15	12	8 4 12081 313672

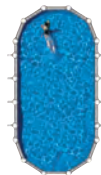
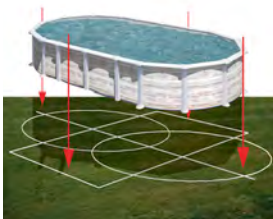

MEDIDA PISCINA
POOL SIZE
DIMENSIONS PISCINE
MISURA PISCINA

ESPACIO NECESARIO
NECESSARY SPACE
ESPACE NECESSAIRE
SPAZIO NECESSARIO

KITPROV7388N	730x375 cm	770x495 cm
KITPROV6188N	610x375 cm	650x495 cm

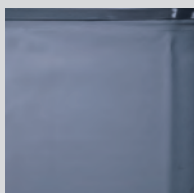

Liner PVC gris
40/100
PVC grey liner
40/100
Liner PVC gris
40/100
Liner PVC grigio
40/100



Protectores de
inyección
Injection saver
Protections
moulées par
injection
Angolare di
protezione



Perfileria de acero
Steel profiles
Poteaux et
margelles acier
Profili in acciaio



Viga de acero enterrada de 15x15 cm que hace innecesarios los postes exteriores, obteniendo mejor aprovechamiento del jardín.

15x15 cm buried steel beam makes unnecessary the outer buttress, optimizing the use of the garden area.

Poteaux en acier à enterrer de 15x15 cm évitant des renforts apparents extérieurs, pour mieux profiter de l'espace du jardin.

Barra di acciaio interrata da 15x15 cm che non rende necessario l'utilizzo delle barre laterali; permette di poter sfruttare al meglio gli spazi del proprio giardino.



Sistema de omegas Omega system Renforts enterrés Sistema omega

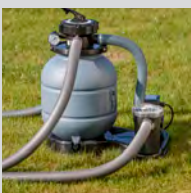

Depuradora arena
(Caudal grupo 6 m³/h)
Sand filter
(Flow group 6 m³/h)
Filtre à sable
(Débit groupe 6 m³/h)
Filtro a sabbia
(Portata gruppo 6 m³/h)



Escalera de seguridad
Plataforma
Safety Ladder
Platform
Échelle sécurité
Plateforme
Scala di sicurezza
Piattaforma

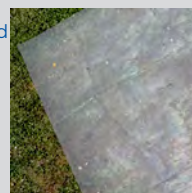

Tapiz protector
(Polietileno)
Floor tapestry
(Polythene)
Tapis de sol en feutre
(Polyéthylène)
Telo di protezione
(Polietilene)

dream pool

serie **GROENLANDIA**

NEW
2021

KITPROV738N



EAN 13

	730x375 cm	132 cm	28.217 l	335 kg	1/120x80	6m³/h	√	√	15	12	8 4 12081 313689
KITPROV738N	730x375 cm	132 cm	28.217 l	335 kg	1/120x80	6m³/h	√	√	15	12	8 4 12081 313689
KITPROV618N	610x375 cm	132 cm	23.281 l	270 kg	1/90x80	6m³/h	√	√	15	12	8 4 12081 313696
KITPROV508N	500x300 cm	132 cm	16.210 l	260 kg	1/90x80	6m³/h	√	√	15	12	8 4 12081 313719

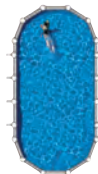
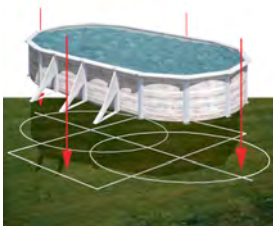

MEDIDA PISCINA
POOL SIZE
DIMENSIONS PISCINE
MISURA PISCINA

ESPACIO NECESARIO
NECESSARY SPACE
ESPACE NECESSAIRE
SPAZIO NECESSARIO

KITPROV738N	730x375 cm	770x595 cm
KITPROV618N	610x375 cm	650x595 cm
KITPROV508N	500x300 cm	540x520 cm

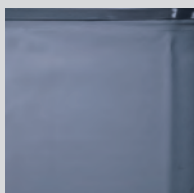

Liner PVC gris
40/100
PVC grey liner
40/100
Liner PVC gris
40/100
Liner PVC grigio
40/100



Protectores de
inyección
Injection saver
Protections
moulées par
injection
Angolare di
protezione



Perfileria de acero
Steel profiles
Poteaux et
margelles acier
Profili in acciaio



KITPR558N



EAN 13

Model	Ø	Height	Capacity (l)	Weight (kg)	Box Size	Flow (m³/h)	Filter	Ladder	Platform	Filter	Box Size	Barcode
KITPR558N	Ø550 cm	132 cm	27.798 l	243 kg	1/90x80	6m³/h	✓	✓	15	12	8 4 12081 313702	
KITPR458N	Ø460 cm	132 cm	19.444 l	238 kg	1/90x80	6m³/h	✓	✓	15	12	8 4 12081 313726	
KITPR358N	Ø350 cm	132 cm	11.250 l	184 kg	1/90x80	6m³/h	✓	✓	15	12	8 4 12081 313733	

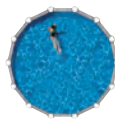
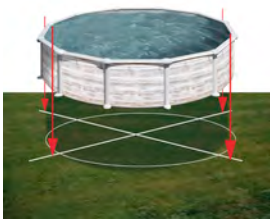

MEDIDA PISCINA
POOL SIZE
DIMENSIONS PISCINE
MISURA PISCINA

ESPACIO NECESARIO
NECESSARY SPACE
ESPACE NECESSAIRE
SPAZIO NECESSARIO

Model	Pool Size	Necessary Space
KITPR558N	Ø 550cm	600x600 cm
KITPR458N	Ø 460cm	500x500 cm
KITPR358N	Ø 350cm	400x400 cm

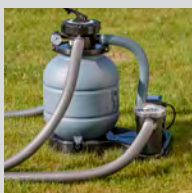

Depuradora arena
(Caudal grupo 6 m³/h)
Sand filter
(Flow group 6 m³/h)
Filtre à sable
(Débit groupe 6 m³/h)
Filtro a sabbia
(Portata gruppo 6 m³/h)



Escalera de seguridad
Plataforma
Safety Ladder
Platform
Échelle sécurité
Plateforme
Scala di sicurezza
Piattoforma

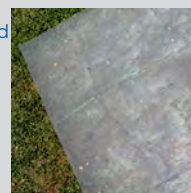

Tapiz protector
(Polietileno)
Floor tapestry
(Polythene)
Tapis de sol en feutre
(Polyéthylène)
Telo di protezione
(Polietilene)

dream pool

serie **FINLANDIA**

NEW
2021

KIT730N



EAN 13

	730x375 cm	120 cm	25.323 l	287 kg	1/90x80	4m³/h	√	15	12	8 4 12081 313740
KIT730N	730x375 cm	120 cm	25.323 l	287 kg	1/90x80	4m³/h	√	15	12	8 4 12081 313740
KIT610N	610x375 cm	120 cm	20.893 l	235 kg	1/80x60	4m³/h	√	15	12	8 4 12081 313757
KIT500N	500x300 cm	120 cm	14.550 l	224 kg	1/80x60	4m³/h	√	15	12	8 4 12081 313764

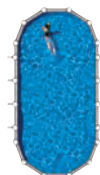
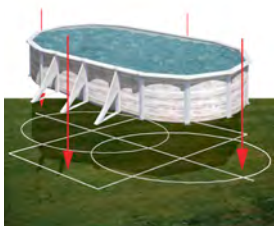

MEDIDA PISCINA
POOL SIZE
DIMENSIONS PISCINE
MISURA PISCINA

ESPACIO NECESARIO
NECESSARY SPACE
ESPACE NECESSAIRE
SPAZIO NECESSARIO

KIT730N	730x375 cm	770x595 cm
KIT610N	610x375 cm	650x595 cm
KIT500N	500x300 cm	540x520 cm

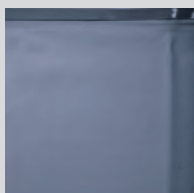

Liner PVC gris 30/100
KIT730GF/KIT610GF: 40/100
PVC grey liner 30/100
KIT730GF/KIT610GF: 40/100
Liner PVC gris 30/100
KIT730GF/KIT610GF: 40/100
Liner PVC grigio 30/100
KIT730GF/KIT610GF: 40/100

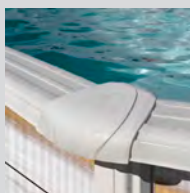

Protectores de
inyección
Injection saver
Protections
moulées par
injection
Angolare di
protezione

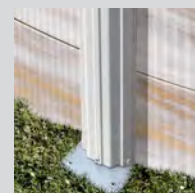

Perfileria de acero
Steel profiles
Poteaux et
margelles acier
Profili in acciaio



NEW
2021

KIT460N



EAN 13

Model	Ø	Height	Capacity (l)	Weight (kg)	Box Size	Flow (m³/h)	Filter	Platform	Steps	EAN 13
KIT460N	Ø460 cm	120 cm	17.450 l	172 kg	1/80x60	4m³/h	√	15	12	8 4 12081 313771
KIT350N	Ø350 cm	120 cm	10.102 l	146 kg	1/80x60	4m³/h	√	15	12	8 4 12081 313788
KIT300N	Ø300 cm	120 cm	7.418 l	136 kg	1/80x60	4m³/h	√	15	12	8 4 12081 313962
KIT240N	Ø240 cm	120 cm	4.750 l	126 kg	1/80x60	4m³/h	√	15	12	8 4 12081 313795

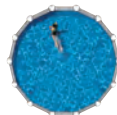
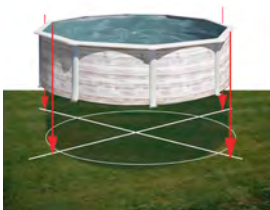

MEDIDA PISCINA
POOL SIZE
DIMENSIONS PISCINE
MISURA PISCINA

ESPACIO NECESARIO
NECESSARY SPACE
ESPACE NECESSAIRE
SPAZIO NECESSARIO

Model	Pool Size	Necessary Space
KIT460N	Ø 460 cm	500x500 cm
KIT350N	Ø 350 cm	400x400 cm
KIT300N	Ø 300 cm	350x350 cm
KIT240N	Ø 240 cm	300x300 cm



Depuradora arena
(Caudal grupo 4 m³/h)
Sand filter
(Flow group 4 m³/h)
Filtre à sable
(Débit groupe 4 m³/h)
Filtro a sabbia
(Portata gruppo 4m³/h)



Escalera de seguridad
Plataforma
Safety Ladder
Platform
Échelle sécurité
Plateforme
Scala di sicurezza
Piattaforma

dream pool

serie **CAPRI**

KITPROV7388GF



EAN 13

Model	Dimensions (cm)	Height (cm)	Capacity (l)	Weight (kg)	Storage (cm)	Flow (m³/h)	Filter	Ladder	Cover	Accessories	Barcode
KITPROV7388GF	730x375	132	28.217	348	1/120x80	6m³/h	√	√	15	12	8 412081 272382
KITPROV6188GF	610x375	132	23.281	279	1/90x80	6m³/h	√	√	15	12	8 412081 272399

🇮🇹 Références non disponibles en France

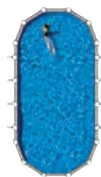
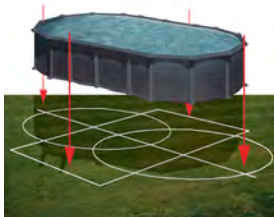

MEDIDA PISCINA
POOL SIZE
DIMENSIONS PISCINE
MISURA PISCINA

ESPACIO NECESARIO
NECESSARY SPACE
ESPACE NECESSAIRE
SPAZIO NECESSARIO

KITPROV7388GF	730x375 cm	770x495 cm
KITPROV6188GF	610x375 cm	650x495 cm

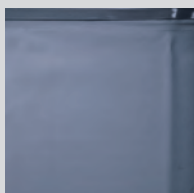

Liner PVC gris
40/100
PVC grey liner
40/100
Liner PVC gris
40/100
Liner PVC grigio
40/100

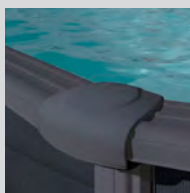

Protectores de
inyección
Injection saver
Protections
moulées par
injection
Angolare di
protezione

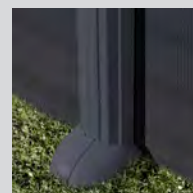

Perfileria de acero
Steel profiles
Poteaux et
margelles acier
Profili in acciaio



Viga de acero enterrada de 15x15 cm que hace innecesarios los postes exteriores, obteniendo mejor aprovechamiento del jardín.

15x15 cm buried steel beam makes unnecessary the outer buttress, optimizing the use of the garden area.

Poteaux en acier à enterrer de 15x15 cm évitant des renforts apparents extérieurs, pour mieux profiter de l'espace du jardin.

Barra di acciaio interrata da 15x15 cm che non rende necessario l'utilizzo delle barre laterali; permette di poter sfruttare al meglio gli spazi del proprio giardino.



Sistema de omegas Omega system Renforts enterrés Sistema omega

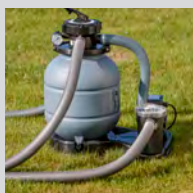

Depuradora arena
(Caudal grupo 6 m³/h)
Sand filter
(Flow group 6 m³/h)
Filtre à sable
(Débit groupe 6 m³/h)
Filtro a sabbia
(Portata gruppo 6 m³/h)



Escalera de seguridad
Plataforma
Safety Ladder
Platform
Échelle sécurité
Plateforme
Scala di sicurezza
Piattaforma

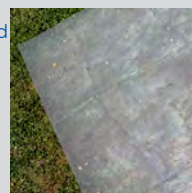

Tapiz protector
(Polietileno)
Floor tapestry
(Polythene)
Tapis de sol en feutre
(Polyéthylène)
Telo di protezione
(Polietilene)

dream pool

serie **GRANADA**

KITPROV738GF



EAN 13

Model	Dimensions (LxW)	Height	Capacity (l)	Weight (kg)	Box Size (LxW)	Flow Rate (m³/h)	Filter	Ladder	Cover	Accessories	Barcode
KITPROV738GF	730x375 cm	132 cm	28.217 l	335 kg	1/120x80	6m³/h	√	√	15	12	8 412081 272405
KITPROV618GF	610x375 cm	132 cm	23.281 l	270 kg	1/90x80	6m³/h	√	√	15	12	8 412081 272412
KITPROV508GF	500x300 cm	132 cm	16.210 l	260 kg	1/90x80	6m³/h	√	√	15	12	8 412081 272429

Références non disponibles en France

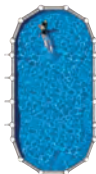
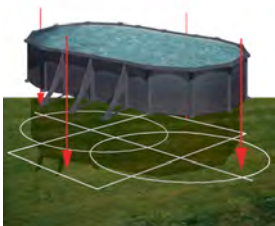

	MEDIDA PISCINA POOL SIZE DIMENSIONS PISCINE MISURA PISCINA	ESPACIO NECESARIO NECESSARY SPACE ESPACE NECESSAIRE SPAZIO NECESSARIO
KITPROV738GF	730x375 cm	770x595 cm
KITPROV618GF	610x375 cm	650x595 cm
KITPROV508GF	500x300 cm	540x520 cm

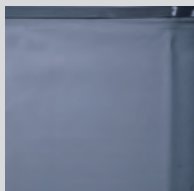

Liner PVC gris
40/100
PVC grey liner
40/100
Liner PVC gris
40/100
Liner PVC grigio
40/100

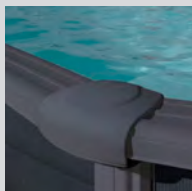

Protectores de
inyección
Injection saver
Protections
moulées par
injection
Angolare di
protezione

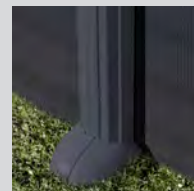

Perfileria de acero
Steel profiles
Poteaux et
margelles acier
Profili in acciaio



KITPR558GF



EAN 13

Model	Ø	Height	Capacity (l)	Weight (kg)	Box Size	Flow (m³/h)	Filter	Ladder	Platform	Length	Width	Barcode
KITPR558GF	Ø550 cm	132 cm	27.798 l	243 kg	1/90x80	6m³/h	✓	✓	15	12	8 412081 272436	
KITPR458GF	Ø460 cm	132 cm	19.444 l	238 kg	1/90x80	6m³/h	✓	✓	15	12	8 412081 272443	
KITPR358GF	Ø350 cm	132 cm	11.250 l	184 kg	1/90x80	6m³/h	✓	✓	15	12	8 412081 272450	

🇫🇷 Références non disponibles en France

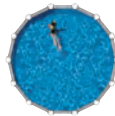
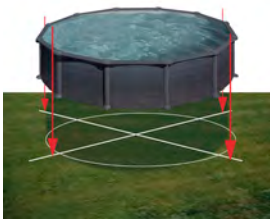

MEDIDA PISCINA
POOL SIZE
DIMENSIONS PISCINE
MISURA PISCINA

ESPACIO NECESARIO
NECESSARY SPACE
ESPACE NECESSAIRE
SPAZIO NECESSARIO

Model	Pool Size	Necessary Space
KITPR558GF	Ø 550cm	600x600 cm
KITPR458GF	Ø 460cm	500x500 cm
KITPR358GF	Ø 350cm	400x400 cm



Depuradora arena
(Caudal grupo 6 m³/h)
Sand filter
(Flow group 6 m³/h)
Filtre à sable
(Débit groupe 6 m³/h)
Filtro a sabbia
(Portata gruppo 6 m³/h)



Escalera de seguridad
Plataforma
Safety Ladder
Platform
Échelle sécurité
Plateforme
Scala di sicurezza
Piattoforma

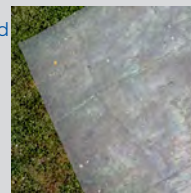

Tapiz protector
(Polietileno)
Floor tapestry
(Polythene)
Tapis de sol en feutre
(Polyéthylène)
Telo di protezione
(Polietilene)

dream pool

serie **KEA**

KIT610GF



EAN 13

	730x375 cm	610x375 cm	500x300 cm
KIT730GF	730x375 cm	610x375 cm	500x300 cm
	120 cm	120 cm	120 cm
	25.323 l	20.893 l	14.550 l
	287 kg	235 kg	224 kg
	1/90x80	1/80x60	1/80x60
	4m³/h	4m³/h	4m³/h
	√	√	√
	15	15	15
	12	12	12
	8 4 1 2 0 8 1 2 7 2 4 6 7	8 4 1 2 0 8 1 2 7 2 4 7 4	8 4 1 2 0 8 1 2 7 3 0 8 2

🇫🇷 Références non disponibles en France

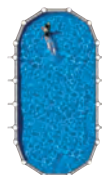

	MEDIDA PISCINA POOL SIZE DIMENSIONS PISCINE MISURA PISCINA	ESPACIO NECESARIO NECESSARY SPACE ESPACE NECESSAIRE SPAZIO NECESSARIO
KIT730GF	730x375 cm	770x595 cm
KIT610GF	610x375 cm	650x595 cm
KIT500GF	500x300 cm	540x520 cm

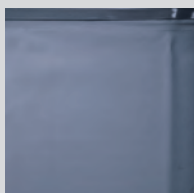

Liner PVC gris 30/100
KIT730GF/KIT610GF: 40/100
PVC grey liner 30/100
KIT730GF/KIT610GF: 40/100
Liner PVC gris 30/100
KIT730GF/KIT610GF: 40/100
Liner PVC grigio 30/100
KIT730GF/KIT610GF: 40/100

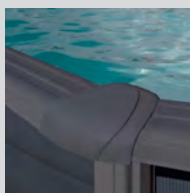

Protectores de inyección
Injection saver
Protections moulées par injection
Angolare di protezione

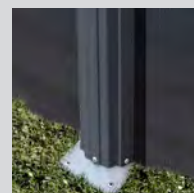

Periferia de acero
Steel profiles
Poteaux et margelles acier
Profili in acciaio



KIT350GF



EAN 13

Model	Ø	Height	Capacity (l)	Weight (kg)	Box Size	Flow Rate (m³/h)	✓	Platform	Ladder	Barcode
KIT460GF	Ø460 cm	120 cm	17.450 l	172 kg	1/80x60	4m³/h	✓	15	12	8 4 1 2 0 8 1 2 7 2 4 9 8
KIT350GF	Ø350 cm	120 cm	10.102 l	146 kg	1/80x60	4m³/h	✓	15	12	8 4 1 2 0 8 1 2 7 2 5 0 4
KIT300GF	Ø300 cm	120 cm	7.418 l	136 kg	1/80x60	4m³/h	✓	15	12	8 4 1 2 0 8 1 3 0 9 0 7 1
KIT240GF	Ø240 cm	120 cm	4.750 l	126 kg	1/80x60	4m³/h	✓	15	12	8 4 1 2 0 8 1 3 0 2 7 2 0

🇫🇷 Références non disponibles en France

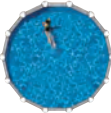
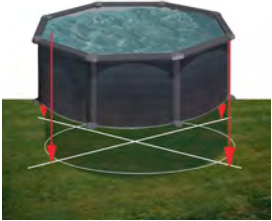

	MEDIDA PISCINA POOL SIZE DIMENSIONS PISCINE MISURA PISCINA	ESPACIO NECESARIO NECESSARY SPACE ESPACE NECESSAIRE SPAZIO NECESSARIO
KIT460GF	Ø 460cm	500x500 cm
KIT350GF	Ø 350cm	400x400 cm
KIT300GF	Ø 300cm	350x350 cm
KIT240GF	Ø 240cm	300x300 cm



Depuradora arena
(Caudal grupo 4 m³/h)
Sand filter
(Flow group 4 m³/h)
Filtre à sable
(Débit groupe 4 m³/h)
Filtro a sabbia
(Portata gruppo 4m³/h)



Escalera de seguridad
Plataforma
Safety Ladder
Platform
Échelle sécurité
Plateforme
Scala di sicurezza
Piattaforma

dream pool

serie **SANTORINI**

KITPROV7388PO



EAN 13

Model	Dimensions (cm)	Depth (cm)	Volume (l)	Weight (kg)	Box Size (cm)	Flow (m³/h)	Filter	Ladder	Cover	Accessories	Barcode
KITPROV7388PO	730x375	132	28.217	348	1/120x80	6m³/h	√	√	15	12	8 4 12081 264493
KITPROV6188PO	610x375	132	23.281	279	1/90x80	6m³/h	√	√	15	12	8 4 12081 264509

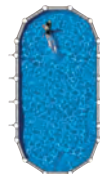
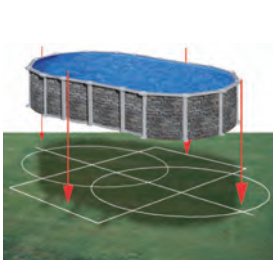

MEDIDA PISCINA POOL SIZE DIMENSIONS PISCINE MISURA PISCINA	ESPACIO NECESARIO NECESSARY SPACE ESPACE NECESSAIRE SPAZIO NECESSARIO
---------------------------------------------------------------------	--------------------------------------------------------------------------------

KITPROV7388PO	730x375 cm	770x495 cm
KITPROV6188PO	610x375 cm	650x495 cm



Liner PVC azul
40/100
PVC blue liner
40/100
Liner PVC bleu
40/100
Liner PVC blu
40/100



Protectores de
inyección
Injection saver
Protections
moulées par
injection
Angolare di
protezione



Perfilería de acero
Steel profiles
Poteaux et
margelles acier
Profili in acciaio



Viga de acero enterrada de 15x15 cm que hace innecesarios los postes exteriores, obteniendo mejor aprovechamiento del jardín.

15x15 cm buried steel beam makes unnecessary the outer buttress, optimizing the use of the garden area.

Poteaux en acier à enterrer de 15x15 cm évitant des renforts apparents extérieurs, pour mieux profiter de l'espace du jardin.

Barra di acciaio interrata da 15x15 cm che non rende necessario l'utilizzo delle barre laterali; permette di poter sfruttare al meglio gli spazi del proprio giardino.



Sistema de omegas Omega system Renforts enterrés Sistema omega

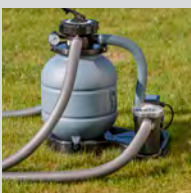

Depuradora arena
(Caudal grupo 6 m³/h)
Sand filter
(Flow group 6 m³/h)
Filtre à sable
(Débit groupe 6 m³/h)
Filtro a sabbia
(Portata gruppo 6 m³/h)



Escalera de seguridad
Plataforma
Safety Ladder
Platform
Échelle sécurité
Plateforme
Scala di sicurezza
Piattaforma

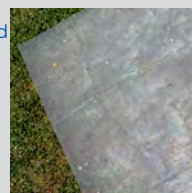

Tapiz protector
(Polietileno)
Floor tapestry
(Polythene)
Tapis de sol en feutre
(Polyéthylène)
Telo di protezione
(Polietilene)

dream pool

serie **CÓRCEGA**



KITPROV618PO



EAN 13

	730x375 cm	610x375 cm	500x300 cm
KITPROV738PO	730x375 cm	610x375 cm	500x300 cm
	132 cm	132 cm	132 cm
	28.217 l	23.281 l	16.210 l
	335 kg	270 kg	260 kg
	1/120x80	1/90x80	1/90x80
	6m ³ /h	6m ³ /h	6m ³ /h
	√	√	√
	√	√	√
	15	15	15
	12	12	12
	8 412081 264516	8 412081 264523	8 412081 264547

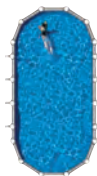
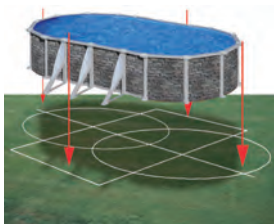

MEDIDA PISCINA
POOL SIZE
DIMENSIONS PISCINE
MISURA PISCINA

ESPACIO NECESARIO
NECESSARY SPACE
ESPACE NECESSAIRE
SPAZIO NECESSARIO

	730x375 cm	610x375 cm	500x300 cm
KITPROV738PO	730x375 cm	610x375 cm	500x300 cm
KITPROV618PO	770x595 cm	650x595 cm	540x520 cm
KITPROV508PO			



Liner PVC azul
40/100
PVC blue liner
40/100
Liner PVC bleu
40/100
Liner PVC blu
40/100



Protectores de
inyección
Injection saver
Protections
moulées par
injection
Angolare di
protezione



Perfilería de acero
Steel profiles
Poteaux et
margelles acier
Profili in acciaio



KITPR558PO



EAN 13

Model	Ø	Height	Capacity (l)	Weight (kg)	Box Size	Flow Rate (m³/h)	✓	✓	15	12	Barcode
KITPR558PO	Ø550 cm	132 cm	27.798 l	243 kg	1/90x80	6m³/h	✓	✓	15	12	8 412081 264530
KITPR458PO	Ø460 cm	132 cm	19.444 l	238 kg	1/90x80	6m³/h	✓	✓	15	12	8 412081 264554
KITPR358PO	Ø350 cm	132 cm	11.250 l	184 kg	1/90x80	6m³/h	✓	✓	15	12	8 412081 264561

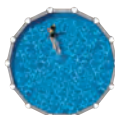

MEDIDA PISCINA
POOL SIZE
DIMENSIONS PISCINE
MISURA PISCINA

ESPACIO NECESARIO
NECESSARY SPACE
ESPACE NECESSAIRE
SPAZIO NECESSARIO

Model	Pool Size	Necessary Space
KITPR558PO	Ø 550cm	600x600 cm
KITPR458PO	Ø 460cm	500x500 cm
KITPR358PO	Ø 350cm	400x400 cm

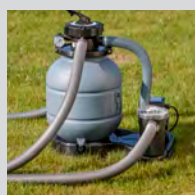

Depuradora arena
(Caudal grupo 6 m³/h)
Sand filter
(Flow group 6 m³/h)
Filtre à sable
(Débit groupe 6 m³/h)
Filtro a sabbia
(Portata gruppo 6 m³/h)



Escalera de seguridad
Plataforma
Safety Ladder
Platform
Échelle sécurité
Plateforme
Scala di sicurezza
Piattaforma

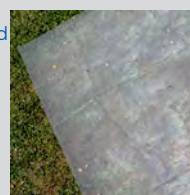

Tapiz protector
(Polietileno)
Floor tapestry
(Polythene)
Tapis de sol en feutre
(Polyéthylène)
Telo di protezione
(Polietilene)

dream pool

serie **CERDEÑA**



KIT610PO



EAN 13

	730x375 cm	610x375 cm	500x300 cm
KIT730PO	730x375 cm	610x375 cm	500x300 cm
	120 cm	120 cm	120 cm
	25.323 l	20.893 l	14.550 l
	287 kg	235 kg	224 kg
	1/90x80	1/80x60	1/80x60
	4m³/h	4m³/h	4m³/h
	√	√	√
	15	15	15
	12	12	12
	8 4 120 81 264 578	8 4 120 81 264 585	8 4 120 81 264 592

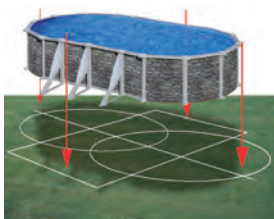

MEDIDA PISCINA
POOL SIZE
DIMENSIONS PISCINE
MISURA PISCINA

ESPACIO NECESARIO
NECESSARY SPACE
ESPACE NECESSAIRE
SPAZIO NECESSARIO

KIT730PO	730x375 cm	770x595 cm
KIT610PO	610x375 cm	650x595 cm
KIT500PO	500x300 cm	540x520 cm



Liner PVC azul 30/100
KIT730PO/KIT610PO: 40/100
PVC blue liner 30/100
KIT730PO/KIT610PO: 40/100
Liner PVC bleu 30/100
KIT730PO/KIT610PO: 40/100
Liner PVC blu 30/100
KIT730PO/KIT610PO: 40/100

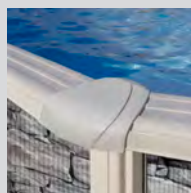

Protectores de inyección
Injection saver
Protections moulées par injection
Angolare di protezione

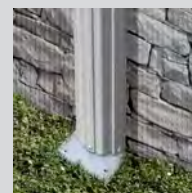

Perfilería de acero
Steel profiles
Poteaux et margelles acier
Profili in acciaio



KIT350PO



EAN 13

Model	Ø	Height	Capacity (l)	Weight (kg)	Box Size	Flow Rate (m³/h)	✓	Platform	Ladder	Filter	Barcode
KIT460PO	Ø460 cm	120 cm	17.450 l	172 kg	1/80x60	4m³/h	✓	15	12	8 412081 264608	
KIT350PO	Ø350 cm	120 cm	10.102 l	146 kg	1/80x60	4m³/h	✓	15	12	8 412081 264615	
KIT300PO	Ø300 cm	120 cm	7.418 l	136 kg	1/80x60	4m³/h	✓	15	12	8 412081 309118	
KIT240PO	Ø240 cm	120 cm	4.750 l	126 kg	1/80x60	4m³/h	✓	15	12	8 412081 264622	

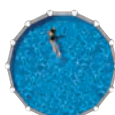

MEDIDA PISCINA
POOL SIZE
DIMENSIONS PISCINE
MISURA PISCINA

ESPACIO NECESARIO
NECESSARY SPACE
ESPACE NECESSAIRE
SPAZIO NECESSARIO

Model	Pool Diameter	Required Space
KIT460PO	Ø 460cm	500x500 cm
KIT350PO	Ø 350cm	400x400 cm
KIT300PO	Ø 300cm	350x350 cm
KIT240PO	Ø 240cm	300x300 cm

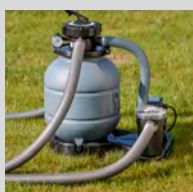

Depuradora arena
(Caudal grupo 4 m³/h)
Sand filter
(Flow group 4 m³/h)
Filtre à sable
(Débit groupe 4 m³/h)
Filtro a sabbia
(Portata gruppo 4 m³/h)



Escalera de seguridad
Plataforma
Safety Ladder
Platform
Échelle sécurité
Plateforme
Scala di sicurezza
Piattoforma

dream pool

serie **AMAZONIA**



KITPROV6188WO



EAN 13

	730x375 cm	132 cm	28.217 l	348 kg	1/120x80	6m³/h	√	√	15	12	8 4 12081 257334
KITPROV7388WO	730x375 cm	132 cm	28.217 l	348 kg	1/120x80	6m³/h	√	√	15	12	8 4 12081 257334
KITPROV6188WO	610x375 cm	132 cm	23.281 l	279 kg	1/90x80	6m³/h	√	√	15	12	8 4 12081 257341

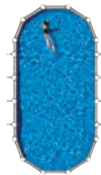

MEDIDA PISCINA
POOL SIZE
DIMENSIONS PISCINE
MISURA PISCINA

ESPACIO NECESARIO
NECESSARY SPACE
ESPACE NECESSAIRE
SPAZIO NECESSARIO

KITPROV7388WO	730x375 cm	770x495 cm
KITPROV6188WO	610x375 cm	650x495 cm



Liner PVC azul
40/100
PVC blue liner
40/100
Liner PVC bleu
40/100
Liner PVC blu
40/100

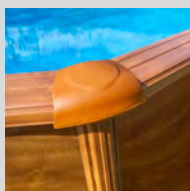

Protectores de
inyección
Injection saver
Protections
moulées par
injection
Angolare di
protezione

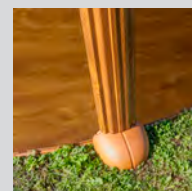

Perfilería de acero
Steel profiles
Poteaux et
margelles acier
Profili in acciaio



Viga de acero enterrada de 15x15 cm que hace innecesarios los postes exteriores, obteniendo mejor aprovechamiento del jardín.

15x15 cm buried steel beam makes unnecessary the outer buttress, optimizing the use of the garden area.

Poteaux en acier à enterrer de 15x15 cm évitant des renforts apparents extérieurs, pour mieux profiter de l'espace du jardin.

Barra di acciaio interrata da 15x15 cm che non rende necessario l'utilizzo delle barre laterali; permette di poter sfruttare al meglio gli spazi del proprio giardino.



Sistema de omegas Omega system Renforts enterrés Sistema omega

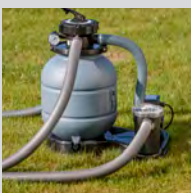

Depuradora arena
(Caudal grupo 6 m³/h)
Sand filter
(Flow group 6 m³/h)
Filtre à sable
(Débit groupe 6 m³/h)
Filtro a sabbia
(Portata gruppo 6)m³/h



Escalera de seguridad
Plataforma
Safety Ladder
Platform
Échelle sécurité
Plateforme
Scala di sicurezza
Piattaforma

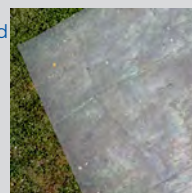

Tapiz protector
(Polietileno)
Floor tapestry
(Polythene)
Tapis de sol en feutre
(Polyéthylène)
Telo di protezione
(Polietilene)

dream pool

serie

MAURITIUS



KITPROV738WO



EAN 13

Model	Dimensions (L x W)	Height	Volume	Weight	Box Size	Flow Rate	Filter	Ladder	Other	Accessories	Barcode
KITPROV738WO	730x375 cm	132 cm	28.217 l	335 kg	1/120x80	6m³/h	√	√	15	12	8 4 12081 257358
KITPROV618WO	610x375 cm	132 cm	23.281 l	270 kg	1/90x80	6m³/h	√	√	15	12	8 4 12081 257365
KITPROV508WO	500x300 cm	132 cm	16.210 l	260 kg	1/90x80	6m³/h	√	√	15	12	8 4 12081 258089

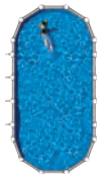

MEDIDA PISCINA
POOL SIZE
DIMENSIONS PISCINE
MISURA PISCINA

ESPACIO NECESARIO
NECESSARY SPACE
ESPACE NECESSAIRE
SPAZIO NECESSARIO

Model	Dimensions (L x W)	Necessary Space (L x W)
KITPROV738WO	730x375 cm	770x595 cm
KITPROV618WO	610x375 cm	650x595 cm
KITPROV508WO	500x300 cm	540x520 cm



Liner PVC azul
40/100
PVC blue liner
40/100
Liner PVC bleu
40/100
Liner PVC blu
40/100

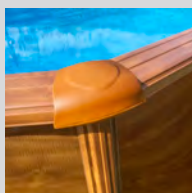

Protectores de
inyección
Injection saver
Protections
moulées par
injection
Angolare di
protezione

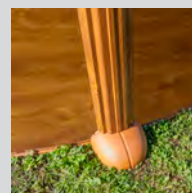

Perfilería de acero
Steel profiles
Poteaux et
margelles acier
Profili in acciaio



KITPR558WO



EAN 13

Model	Pool Diameter	Pool Height	Capacity (l)	Weight (kg)	Box Size	Flow Rate (m³/h)	Filter	Ladder	Platform	Filter	Boxes	Barcode
KITPR558WO	Ø550 cm	132 cm	27.798 l	243 kg	1/90x80	6m³/h	√	√	15	12	8 412081 257372	
KITPR458WO	Ø460 cm	132 cm	19.444 l	238 kg	1/90x80	6m³/h	√	√	15	12	8 412081 257389	
KITPR358WO	Ø350 cm	132 cm	11.250 l	184 kg	1/90x80	6m³/h	√	√	15	12	8 412081 257396	

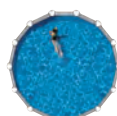

MEDIDA PISCINA
POOL SIZE
DIMENSIONS PISCINE
MISURA PISCINA

ESPACIO NECESARIO
NECESSARY SPACE
ESPACE NECESSAIRE
SPAZIO NECESSARIO

Model	Pool Size	Necessary Space
KITPR558WO	Ø 550cm	600x600 cm
KITPR458WO	Ø 460cm	500x500 cm
KITPR358WO	Ø 350cm	400x400 cm

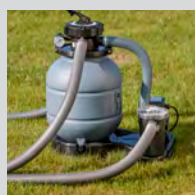

Depuradora arena
(Caudal grupo 6 m³/h)
Sand filter
(Flow group 6 m³/h)
Filtre à sable
(Débit groupe 6 m³/h)
Filtro a sabbia
(Portata gruppo 6)m³/h



Escalera de seguridad
Plataforma
Safety Ladder
Platform
Échelle sécurité
Plateforme
Scala di sicurezza
Piattoforma

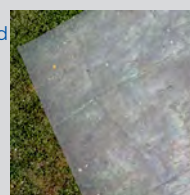

Tapiz protector
(Polietileno)
Floor tapestry
(Polythene)
Tapis de sol en feutre
(Polyéthylène)
Telo di protezione
(Polietilene)

dream pool

serie **PACIFIC**



KIT730WO



EAN 13

KIT730W	730x375 cm	120 cm	25.323 l	287 kg	1/90x80	4m ³ /h	√	15	12	8 4 1 2 0 8 1 2 3 2 2 4 9
KIT610W	610x375 cm	120 cm	20.893 l	235 kg	1/80x60	4m ³ /h	√	15	12	8 4 1 2 0 8 1 2 2 5 1 0 4
KIT500W	500x300 cm	120 cm	14.550 l	224 kg	1/80x60	4m ³ /h	√	15	12	8 4 1 2 0 8 1 2 3 1 0 6 8

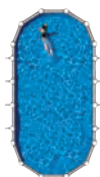

MEDIDA PISCINA
POOL SIZE
DIMENSIONS PISCINE
MISURA PISCINA

ESPACIO NECESARIO
NECESSARY SPACE
ESPACE NECESSAIRE
SPAZIO NECESSARIO

KIT730W	730x375 cm	770x595 cm
KIT610W	610x375 cm	650x595 cm
KIT500W	500x300 cm	540x520 cm



Liner PVC azul 30/100
KIT730W/KIT610W: 40/100
PVC blue liner 30/100
KIT730W/KIT610W: 40/100
Liner PVC bleu 30/100
KIT730W/KIT610W: 40/100
Liner PVC blu 30/100
KIT730W/KIT610W: 40/100

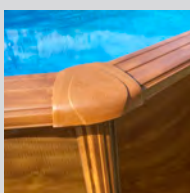

Protectores de inyección
Injection saver
Protections moulées par injection
Angolare di protezione

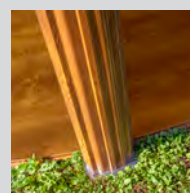

Perfilería de acero
Steel profiles
Poteaux et margelles acier
Profili in acciaio



KIT460WO



EAN 13

	Ø	H	V	P	Paquete	Flujo	✓	Plataforma	Escalera	Barcode
KIT460W	Ø460 cm	120 cm	17.450 l	172 kg	1/80x60	4m ³ /h	✓	15	12	8 4 1 2 0 8 1 2 2 5 1 1 1
KIT350W	Ø350 cm	120 cm	10.102 l	146 kg	1/80x60	4m ³ /h	✓	15	12	8 4 1 2 0 8 1 2 2 5 7 2 2
KIT300W	Ø300 cm	120 cm	7.418 l	136 kg	1/80x60	4m ³ /h	✓	15	12	8 4 1 2 0 8 1 3 0 9 0 9 5
KIT240W	Ø240 cm	120 cm	4.750 l	126 kg	1/80x60	4m ³ /h	✓	15	12	8 4 1 2 0 8 1 2 2 6 1 6 3

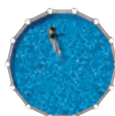

MEDIDA PISCINA
POOL SIZE
DIMENSIONS PISCINE
MISURA PISCINA

ESPACIO NECESARIO
NECESSARY SPACE
ESPACE NECESSAIRE
SPAZIO NECESSARIO

	MEDIDA PISCINA	ESPACIO NECESARIO
KIT460W	Ø 460cm	500x500 cm
KIT350W	Ø 350cm	400x400 cm
KIT300W	Ø 300cm	350x350 cm
KIT240W	Ø 240cm	300x300 cm

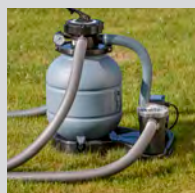

Depuradora arena
(Caudal grupo 4 m³/h)
Sand filter
(Flow group 4 m³/h)
Filtre à sable
(Débit groupe 4 m³/h)
Filtro a sabbia
(Portata gruppo 4 m³/h)



Escalera de seguridad
Plataforma
Safety Ladder
Platform
Échelle sécurité
Plateforme
Scala di sicurezza
Piattaforma

dream pool

serie **SICILIA**



KITPROV503W



EAN 13

KITPROV503W

500x300 cm

120 cm

14.550 l

205 kg

1/80x60

3,8m³/h

√

15

12

8 4 12081 258164

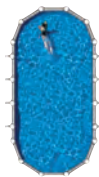

MEDIDA PISCINA
POOL SIZE
DIMENSIONS PISCINE
MISURA PISCINA

ESPACIO NECESARIO
NECESSARY SPACE
ESPACE NECESSAIRE
SPAZIO NECESSARIO

KITPROV503W

500x300 cm

540x520 cm



Liner PVC azul
30/100
PVC blue liner
30/100
Liner PVC bleu
30/100
Liner PVC blu
30/100

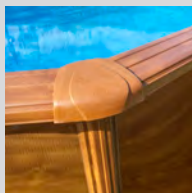

Protectores de
inyección
Injection saver
Protections
moulées par
injection
Angolare di
protezione

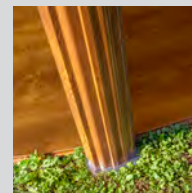

Perfilería de acero
Steel profiles
Poteaux et
margelles acier
Profili in acciaio



KITPR453W



EAN 13

	Icon 1	Icon 2	Icon 3	Icon 4	Icon 5	Icon 6	Icon 7	Icon 8	Icon 9	Icon 10	Icon 11	Icon 12
KITPR453W	Ø460 cm	120 cm	17.450 l	149 kg	3/120x80	3,8m³/h	√	15	12		8 412081 258171	
KITPR353W	Ø350 cm	120 cm	10.102 l	109 kg	3/120x80	3,8m³/h	√	15	12		8 412081 258188	
KITPR303W	Ø300 cm	120 cm	7.418 l	94 kg	3/120x80	3,8m³/h	√	15	12		8 412081 265087	

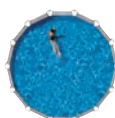

MEDIDA PISCINA
POOL SIZE
DIMENSIONS PISCINE
MISURA PISCINA

ESPACIO NECESARIO
NECESSARY SPACE
ESPACE NECESSAIRE
SPAZIO NECESSARIO

KITPR453W	Ø 460cm	500x500 cm
KITPR353W	Ø 350cm	400x400 cm
KITPR303W	Ø 300cm	350x350 cm

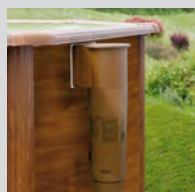

Filtro de cartucho
(3,8 m³/h)
Cartidge filter
(3,8 m³/h)
Filtre à cartouche
(3,8 m³/h)
Filtro a cartuccia
(3,8 m³/h)



Escalera de seguridad
Plataforma
Safety Ladder
Platform
Échelle sécurité
Plateforme
Scala di sicurezza
Piattaforma

dream pool

serie **HAITI**



KITPROV9188



EAN 13

Model	Dimensions (cm)	Height (cm)	Capacity (l)	Weight (kg)	Filter (l/h)	Accessories	Accessories	Accessories	Accessories	Accessories	Accessories	Accessories	Accessories	Accessories	Accessories	Accessories	Accessories	Accessories	Accessories
KITPROV10288	1000x550	132	56.111	681	1/120x100	10m ³ /h	✓	✓	15	12	8	4 120 81 224626							
KITPROV9188	915x470	132	43.595	570	1/120x80	8m ³ /h	✓	✓	15	12	8	4 120 81 220215							
KITPROV8188	800x470	132	37.474	474	1/120x80	8m ³ /h	✓	✓	15	12	8	4 120 81 224633							
KITPROV7388	730x375	132	28.217	348	1/120x80	6m ³ /h	✓	✓	15	12	8	4 120 81 220222							
KITPROV6188	610x375	132	23.281	279	1/90x80	6m ³ /h	✓	✓	15	12	8	4 120 81 221328							

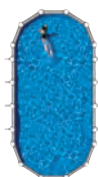
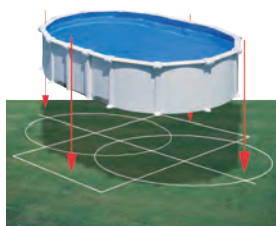

	MEDIDA PISCINA POOL SIZE DIMENSIONS PISCINE MISURA PISCINA	ESPACIO NECESARIO NECESSARY SPACE ESPACE NECESSAIRE SPAZIO NECESSARIO
KITPROV10288	1000x550 cm	1040x670 cm
KITPROV9188	915x470 cm	955x590 cm
KITPROV8188	800x470 cm	850x590 cm
KITPROV7388	730x375 cm	770x495 cm
KITPROV6188	610x375 cm	650x495 cm



Liner PVC azul
40/100
PVC blue liner
40/100
Liner PVC bleu
40/100
Liner PVC blu
40/100

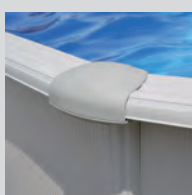

Protectores de
inyección
Injection saver
Protections
moulées par
injection
Angolare di
protezione



Perfileria de acero
Steel profiles
Poteaux et
margelles acier
Profili in acciaio



Viga de acero enterrada de 15x15 cm que hace innecesarios los postes exteriores, obteniendo mejor aprovechamiento del jardín.

15x15 cm buried steel beam makes unnecessary the outer buttress, optimizing the use of the garden area.

Poteaux en acier à enterrer de 15x15 cm évitant des renforts apparents extérieurs, pour mieux profiter de l'espace du jardin.

Barra di acciaio interrata da 15x15 cm che non rende necessario l'utilizzo delle barre laterali; permette di poter sfruttare al meglio gli spazi del proprio giardino.



Sistema de omegas Omega system Renforts enterrés Sistema omega

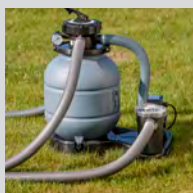

Depuradora arena
(Caudal grupo 10/8/6 m³/h)
Sand filter
(Flow group 10/8/6 m³/h)
Filtre à sable
(Débit groupe 10/8/6 m³/h)
Filtro a sabbia
(Portata gruppo 10/8/6m³/h)



Escalera de seguridad
Plataforma
Safety Ladder
Platform
Échelle sécurité
Plateforme
Scala di sicurezza
Piattaforma

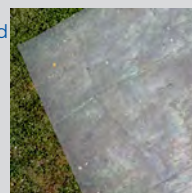

Tapiz protector
(Polietileno)
Floor tapestry
(Polythene)
Tapis de sol en feutre
(Polyéthylène)
Telo di protezione
(Polietilene)

dream pool

serie **ATLANTIS**



KITPROV918



EAN 13

Model	Dimensions (cm)	Height (cm)	Capacity (l)	Weight (kg)	Filter	Flow (m³/h)	✓	✓	15	12	Barcode
KITPROV1028	1000x550	132	56.111	482	1/120x100	10	✓	✓	15	12	8 4 12081 220239
KITPROV918	915x470	132	43.595	466	1/120x80	8	✓	✓	15	12	8 4 12081 211978
KITPROV818	800x470	132	37.474	415	1/120x80	8	✓	✓	15	12	8 4 12081 211565
KITPROV738	730x375	132	28.217	348	1/120x80	6	✓	✓	15	12	8 4 12081 211985
KITPROV618	610x375	132	23.281	279	1/90x80	6	✓	✓	15	12	8 4 12081 211572
KITPROV508	500x300	132	16.210	260	1/90x80	6	✓	✓	15	12	8 4 12081 258119

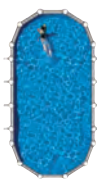
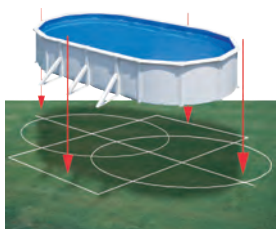

MEDIDA PISCINA
POOL SIZE
DIMENSIONS PISCINE
MISURA PISCINA

ESPACIO NECESARIO
NECESSARY SPACE
ESPACE NECESSAIRE
SPAZIO NECESSARIO

Model	Dimensions (cm)	Necessary Space (cm)
KITPROV1028	1000x550	1040x770
KITPROV918	915x470	955x690
KITPROV818	800x470	850x690
KITPROV738	730x375	770x595
KITPROV618	610x375	650x595
KITPROV508	500x300	540x520



Liner PVC azul
40/100
PVC blue liner
40/100
Liner PVC bleu
40/100
Liner PVC blu
40/100



Protectores de
inyección
Injection saver
Protections
moulées par
injection
Angolare di
protezione



Perfilería de acero
Steel profiles
Poteaux et
margelles acier
Profili in acciaio



KITPR558



EAN 13

Model	Pool Diameter	Pool Height	Volume	Weight	Box Size	Flow Rate	Feature 1	Feature 2	Feature 3	Feature 4	Feature 5	Barcode
KITPR558	Ø550 cm	132 cm	27.798 l	243 kg	1/90x80	6m³/h	✓	✓	15	12	8 4 12081 211589	
KITPR458	Ø460 cm	132 cm	19.444 l	238 kg	1/90x80	6m³/h	✓	✓	15	12	8 4 12081 211596	
KITPR358	Ø350 cm	132 cm	11.250 l	184 kg	1/90x80	6m³/h	✓	✓	15	12	8 4 12081 233864	

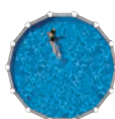
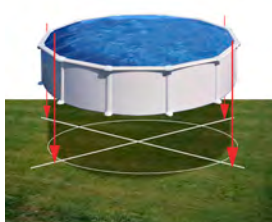

MEDIDA PISCINA
POOL SIZE
DIMENSIONS PISCINE
MISURA PISCINA

ESPACIO NECESARIO
NECESSARY SPACE
ESPACE NECESSAIRE
SPAZIO NECESSARIO

Model	Pool Diameter	Required Space
KITPR558	Ø 550cm	600x600 cm
KITPR458	Ø 460cm	500x500 cm
KITPR358	Ø 350cm	400x400 cm

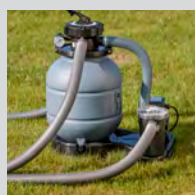

Depuradora arena
(Caudal grupo 10/8/6 m³/h)
Sand filter
(Flow group 10/8/6 m³/h)
Filtre à sable
(Débit groupe 10/8/6 m³/h)
Filtro a sabbia
(Portata gruppo 10/8/6m³/h)



Escalera de seguridad
Plataforma
Safety Ladder
Platform
Échelle sécurité
Plateforme
Scala di sicurezza
Piattoforma

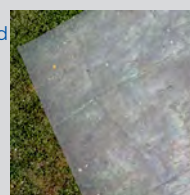

Tapiz protector
(Polietileno)
Floor tapestry
(Polythene)
Tapis de sol en feutre
(Polyéthylène)
Telo di protezione
(Polietilene)

dream pool

serie **FIDJI**



KIT730ECO



EAN 13

	730x375 cm	610x375 cm	500x300 cm
KIT730ECO	730x375 cm	610x375 cm	500x300 cm
	120 cm	120 cm	120 cm
	25.323 l	20.893 l	14.550 l
	287 kg	235 kg	224 kg
	1/90x80	1/80x60	1/80x60
	4m ³ /h	4m ³ /h	4m ³ /h
	√	√	√
	15	15	15
	12	12	12
	8 4 1 2 0 8 1 2 1 1 3 9 8	8 4 1 2 0 8 1 2 1 1 4 0 4	8 4 1 2 0 8 1 2 3 1 0 3 7

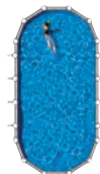
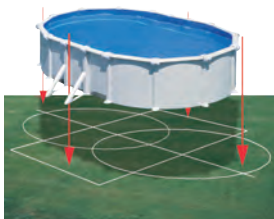

MEDIDA PISCINA
POOL SIZE
DIMENSIONS PISCINE
MISURA PISCINA

ESPACIO NECESARIO
NECESSARY SPACE
ESPACE NECESSAIRE
SPAZIO NECESSARIO

	MEDIDA PISCINA POOL SIZE DIMENSIONS PISCINE MISURA PISCINA	ESPACIO NECESARIO NECESSARY SPACE ESPACE NECESSAIRE SPAZIO NECESSARIO
KIT730ECO	730x375 cm	770x595 cm
KIT610ECO	610x375 cm	650x595 cm
KIT500ECO	500x300 cm	540x520 cm



Liner PVC azul 30/100
KIT730/KIT610: 40/100
PVC blue liner 30/100
KIT730/KIT610: 40/100
Liner PVC bleu 30/100
KIT730/KIT610: 40/100
Liner PVC blu 30/100
KIT730/KIT610: 40/100



Protectores de inyección
Injection saver
Protections moulées par injection
Angolare di protezione



Perfilería de acero
Steel profiles
Poteaux et margelles acier
Profili in acciaio



KIT460ECO



EAN 13

Model	Ø	Height	Capacity (l)	Weight (kg)	Box Size	Flow Rate (m³/h)	Safety Ladder	Platform	Accessories	Barcode
KIT550ECO	Ø550 cm	120 cm	24.944 l	209 kg	1/80x60	4m³/h	√	15	12	8 4 1 2 0 8 1 2 1 1 4 1 1
KIT460ECO	Ø460 cm	120 cm	17.450 l	172 kg	1/80x60	4m³/h	√	15	12	8 4 1 2 0 8 1 2 1 1 4 2 8
KIT350ECO	Ø350 cm	120 cm	10.102 l	146 kg	1/80x60	4m³/h	√	15	12	8 4 1 2 0 8 1 2 1 1 4 3 5
KIT300ECO	Ø300 cm	120 cm	7.418 l	136 kg	1/80x60	4m³/h	√	15	12	8 4 1 2 0 8 1 2 2 8 7 5 4
KIT240ECO	Ø240 cm	120 cm	4.750 l	126 kg	1/80x60	4m³/h	√	15	12	8 4 1 2 0 8 1 2 4 0 8 3 1

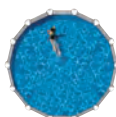
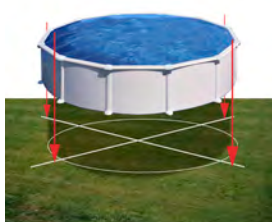

MEDIDA PISCINA
POOL SIZE
DIMENSIONS PISCINE
MISURA PISCINA

ESPACIO NECESARIO
NECESSARY SPACE
ESPACE NECESSAIRE
SPAZIO NECESSARIO

Model	Ø	Required Space
KIT550ECO	Ø 550 cm	600x600 cm
KIT460ECO	Ø 460 cm	500x500 cm
KIT350ECO	Ø 350 cm	400x400 cm
KIT300ECO	Ø 300 cm	350x350 cm
KIT240ECO	Ø 240 cm	300x300 cm

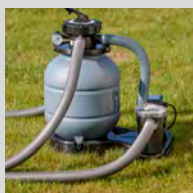

Depuradora arena
(Caudal grupo 4 m³/h)
Sand filter
(Flow group 4 m³/h)
Filtre à sable
(Débit groupe 4 m³/h)
Filtro a sabbia
(Portata gruppo 4 m³/h)



Escalera de seguridad
Plataforma
Safety Ladder
Platform
Échelle sécurité
Plateforme
Scala di sicurezza
Piattaforma

dream pool

serie **VARADERO**



KITPROV62270



EAN 13

Model	Dimensions (cm)	Depth (cm)	Capacity (l)	Weight (kg)	Box Size	Flow Rate (m³/h)	Safety	Accessories	Accessories	Accessories	Accessories	Accessories	Barcode
KITPROV6270	640x390	120	20.652	311	1/90x80	4m³/h	√	√	15	12	8	4 120 81 2 116 33	
KITPROV4870	500x340	120	13.696	284	1/90x80	4m³/h	√	√	15	12	8	4 120 81 2 319 21	

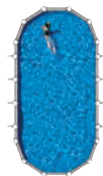
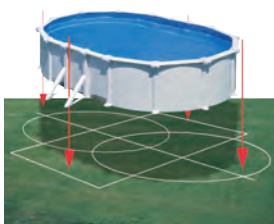

	MEDIDA PISCINA POOL SIZE DIMENSIONS PISCINE MISURA PISCINA	ESPACIO NECESARIO NECESSARY SPACE ESPACE NECESSAIRE SPAZIO NECESSARIO
KITPROV6270	640x390 cm	700x430 cm
KITPROV4870	500x340 cm	540x380 cm



Liner PVC azul
40/100
PVC blue liner
40/100
Liner PVC bleu
40/100
Liner PVC blu
40/100



Protectores de
inyección
Injection saver
Protections
moulées par
injection
Angolare di
protezione



Perfilería de acero
Steel profiles
Poteaux et
margelles acier
Profili in acciaio



Viga de acero enterrada de 15x15 cm que hace innecesarios los postes exteriores, obteniendo mejor aprovechamiento del jardín.

15x15 cm buried steel beam makes unnecessary the outer buttress, optimizing the use of the garden area.

Poteaux en acier à enterrer de 15x15 cm évitant des renforts apparents extérieurs, pour mieux profiter de l'espace du jardin.

Barra di acciaio interrata da 15x15 cm che non rende necessario l'utilizzo delle barre laterali; permette di poter sfruttare al meglio gli spazi del proprio giardino.



Sistema de omegas Omega system Renforts enterrés Sistema omega

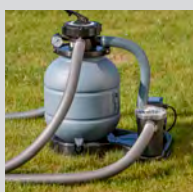

Depuradora arena
(Caudal grupo 4 m³/h)
Sand filter
(Flow group 4 m³/h)
Filtre à sable
(Débit groupe 4 m³/h)
Filtro a sabbia
(Portata gruppo 4 m³/h)



Escalera de seguridad
Plataforma
Safety Ladder
Platform
Échelle sécurité
Plateforme
Scala di sicurezza
Piattaforma

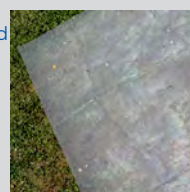

Tapiz protector
(Polietileno)
Floor tapestry
(Polythene)
Tapis de sol en feutre
(Polyéthylène)
Telo di protezione
(Polietilene)

dream pool

serie **BORA BORA**



KITPROV613



EAN 13

KITPROV613	610x375 cm	120 cm	20.893 l	210 kg	1/80x60	3,8m ³ /h	√	15	12	
KITPROV503	500x300 cm	120 cm	14.550 l	205 kg	1/80x60	3,8m ³ /h	√	15	12	

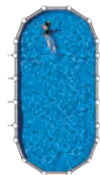
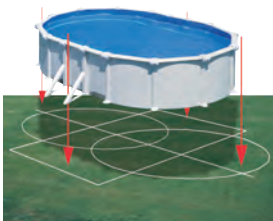

	MEDIDA PISCINA POOL SIZE DIMENSIONS PISCINE MISURA PISCINA	ESPACIO NECESARIO NECESSARY SPACE ESPACE NECESSAIRE SPAZIO NECESSARIO
KITPROV613	610x375 cm	650x595 cm
KITPROV503	500x300 cm	540x520 cm



Liner PVC azul 30/100
KITPROV613: 40/100
PVC blue liner 30/100
KITPROV613: 40/100
Liner PVC bleu 30/100
KITPROV613: 40/100
Liner PVC blu 30/100
KITPROV613: 40/100



Protectores de inyección
Injection saver
Protections moulées par injection
Angolare di protezione



Perfilería de acero
Steel profiles
Poteaux et margelles acier
Profili in acciaio



KITPR453



EAN 13

	Dimensions	Water Level	Faucet	Weight (kg)	Box	Pump	Ladder/Platform	EAN 13
KITPR453	Ø460 cm	120 cm	17.450 l	149 kg	1/80x40	3,8m³/h	✓ 15 12	8 4 1 2 0 8 1 2 0 9 0 0 5
KITPR353	Ø350 cm	120 cm	10.102 l	109 kg	1/80x40	3,8m³/h	✓ 15 12	8 4 1 2 0 8 1 2 0 9 0 1 2
KITPR303	Ø300 cm	120 cm	7.418 l	94 kg	1/80x40	3,8m³/h	✓ 15 12	8 4 1 2 0 8 1 2 3 3 9 0 1

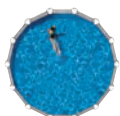

MEDIDA PISCINA
POOL SIZE
DIMENSIONS PISCINE
MISURA PISCINA

ESPACIO NECESARIO
NECESSARY SPACE
ESPACE NECESSAIRE
SPAZIO NECESSARIO

	Pool Size	Necessary Space
KITPR453	Ø 460 cm	500x500 cm
KITPR353	Ø 350 cm	400x400 cm
KITPR303	Ø 300 cm	350x350 cm



Filtro de cartucho
(3,8 m³/h)
Cartidge filter
(3,8 m³/h)
Filtre à cartouche
(3,8 m³/h)
Filtro a cartuccia
(3,8 m³/h)



Escalera de seguridad
Plataforma
Safety Ladder
Platform
Échelle sécurité
Plateforme
Scala di sicurezza
Piattaforma

dream pool

serie **LANZAROTE**

KITWPR452E



EAN 13

Model	Ø	Height	Capacity	Weight	Box Size	Flow Rate	Filter	Steps	Accessories	Barcode
KITWPR452E	Ø450 cm	90 cm	12.717 l	56 kg	8/120x80	2m³/h	√	3,5	3,5	8 4 1 2 0 8 1 2 4 1 4 1 8
KITWPR352E	Ø350 cm	90 cm	7.693 l	47 kg	8/120x80	2m³/h	√	3,5	3,5	8 4 1 2 0 8 1 2 4 1 4 0 1
KITWPR302	Ø300 cm	90 cm	6.358 l	44 kg	8/120x80	2m³/h	√	3,5	3,5	8 4 1 2 0 8 1 2 3 1 0 4 4

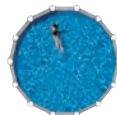
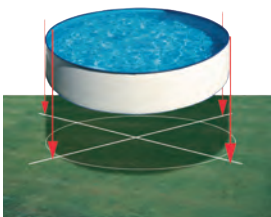

MEDIDA PISCINA
POOL SIZE
DIMENSIONS PISCINE
MISURA PISCINA

ESPACIO NECESARIO
NECESSARY SPACE
ESPACE NECESSAIRE
SPAZIO NECESSARIO

Model	Pool Size	Necessary Space
KITWPR452E	Ø 450 cm	500x500 cm
KITWPR352E	Ø 350 cm	400x400 cm
KITWPR302	Ø 300 cm	350x350 cm



Liner PVC azul
20/100
PVC blue liner
20/100
Liner PVC bleu
20/100
Liner PVC blu
20/100

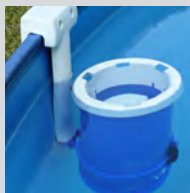

Filtro de cartucho:
2 m³/h
Cartidge filter
2 m³/h
Filtre à cartouche
2 m³/h
Filtro a cartuccia
2 m³/h

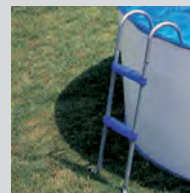

Escalera
2x2 Peldaños
Ladder
2x2 Steps
Échelle
2x2 Marches
Scala
2x2 Gradini

dream pool

serie **TENERIFE**



KITWPR450E



EAN 13

	Ø	H	V	P	PK	F	A	C	CO	CP	Barcode
KITWPR450E	Ø450 cm	90 cm	12.717 l	56 kg	8/120x80	2m³/h	√	3,5	3,5	8 412081 241210	
KITWPR350E	Ø350 cm	90 cm	7.693 l	47 kg	8/120x80	2m³/h	√	3,5	3,5	8 412081 241203	

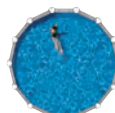
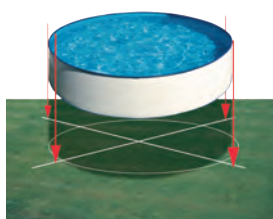

MEDIDA PISCINA
POOL SIZE
DIMENSIONS PISCINE
MISURA PISCINA

ESPACIO NECESARIO
NECESSARY SPACE
ESPACE NECESSAIRE
SPAZIO NECESSARIO

KITWPR450E	Ø 450 cm	500x500 cm
KITWPR350E	Ø 350 cm	400x400 cm

atolón

in-ground pool



PISCINA ENTERRADA DE PARED DE ACERO

LINER: Tratamiento Anti-ultravioleta que retrasa el envejecimiento del P.V.C.

CHAPA: Laminada en frío con tratamiento de galvanización, fosfatación e imprimación.

Troquelada para skimmer, válvulas de retorno y limpiafondos y focos.

PISCINES ENTERRÉES AVEC PAROIS EN ACIER

LINER: Traitement anti-ultraviolets contre le vieillissement du P.V.C.

TÔLE: Tôle laminée à froid et traitée par galvanisation, phosphatage, couche d'apprêt et laquage.

Découpage pour le skimmer, la buse de refoulement et la prise balai. Prédécoupe pour les projecteurs.

IN-GROUND STEEL WALL POOL

LINER: Anti-ultraviolet treatment to slow down P.V.C aging.

PLATE: Galvanized, phosphatized, primed and lacquered cold-rolled plate.

Die cut for skimmer, return valve and cleaner openings and lights.

PISCINE INTERRATA CON PARETI IN ACCIAIO

LINER: Trattamento Anti-ultravioletti - Ritarda l'invecchiamento del P.V.C.

PANNELLO: Laminata a freddo con trattamento di galvanizzazione, fosfatazione e preparazione.

Stampigliatura per Skimmer, valvola di ritorno e puliscifondi e spot.



**MADE
IN
EU**

in-ground pool

serie **MOOREA**



EAN 13

Model	Dimensions (cm)	Depth (cm)	Volume (l)	Weight (kg)	Panel Size (cm)	Flow Rate (m³/h)	Accessories	Barcode
KPEOV8059M	800x400	150	38.840	217/232	1/120x80 1/90x80	10	✓	8 412081 269597
KPEOV7059M	700x320	150	27.470	189/232	1/120x80 1/90x80	10	✓	8 412081 269603
KPEOV6059M	600x320	150	24.420	164/232	1/120x80 1/90x80	10	✓	8 412081 269610
KPEOV5059M	500x300	150	16.015	139/232	1/120x80 1/90x80	10	✓	8 412081 269627



MEDIDA PISCINA
POOL SIZE
DIMENSIONS PISCINE
MISURA PISCINA

ESPACIO NECESARIO
NECESSARY SPACE
ESPACE NECESSAIRE
SPAZIO NECESSARIO

Model	Pool Size (cm)	Necessary Space (cm)
KPEOV8059M	800x400x150	1000x600x165
KPEOV7059M	700x320x150	900x520x165
KPEOV6059M	600x320x150	800x520x165
KPEOV5059M	500x300x150	700x500x165



Liner PVC azul
75/100
PVC blue liner
75/100
Liner bleu PVC
75/100
Liner blu PVC
75/100

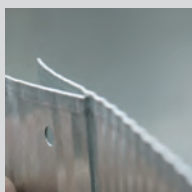

Chapa prelacada
70/100
Prelacquered steel
70/100
Tôle prélaquée
70/100
Lamiera laccata
70/100

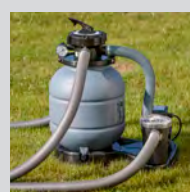

Depuradora arena
(Caudal grupo 10 m³/h)
Sand filter
(Flow group 10 m³/h)
Filtre à sable
(Débit groupe 10 m³/h)
Filtro a sabbia
(Portata gruppo 10 m³/h)



EAN 13

KPE4259M	Ø420 cm	150 cm	18.840 l	126/232 kg	1/120x80 1/90x80	10m ³ /h	✓	8 412081 269634
----------	---------	--------	----------	------------	---------------------	---------------------	---	-----------------

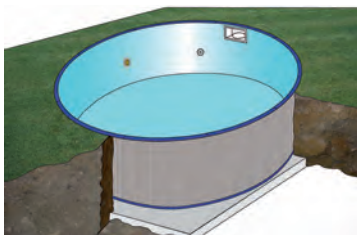

MEDIDA PISCINA
POOL SIZE
DIMENSIONS PISCINE
MISURA PISCINA

ESPACIO NECESARIO
NECESSARY SPACE
ESPACE NECESSAIRE
SPAZIO NECESSARIO

KPE4259M

Ø420x150 cm

Ø620x165 cm



Escalera fácil acceso:
3 peldaños - Inox.
Easy access ladder:
3 steps - Stainless steel
Échelle d'accès facile:
3 marches - Acier
inoxidable
Scala di accesso facile:
3 gradini - Inox



Manta protectora
(Poliéster)
Bottom
protectiveblanket
(Polyester)
Tapis de sol en feutre
(Polyester)
Telo di protezione
(Poliestere)



Skimmer, manguera,
raccordería...
Skimmer, hose,
fittings...
Skimmer, tuyau,
raccords...
Skimmer, tubo,
raccordería...

in-ground pool

serie MADAGASCAR

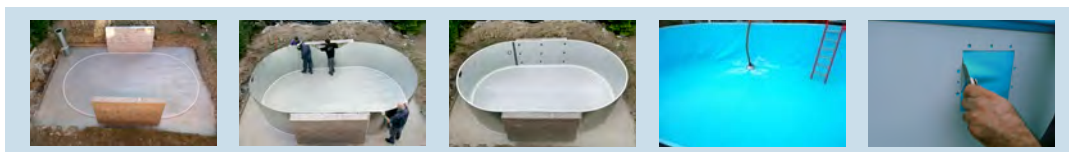

EAN 13

Model	Dimensions (cm)	Depth (cm)	Capacity (l)	Weight (kg)	Panel Size (cm)	Flow Rate (m³/h)	Filter	Barcode
KPEOV8059	800x400	150	38.840	217/224	1/120x80 1/90x80	10	✓	8 412081 269320
KPEOV7059	700x320	150	27.470	189/224	1/120x80 1/90x80	10	✓	8 412081 269337
KPEOV6059	600x320	150	24.420	164/224	1/120x80 1/90x80	10	✓	8 412081 269344
KPEOV5059	500x300	150	16.015	139/224	1/120x80 1/90x80	10	✓	8 412081 258904



MEDIDA PISCINA
POOL SIZE
DIMENSIONS PISCINE
MISURA PISCINA

ESPACIO NECESARIO
NECESSARY SPACE
ESPACE NECESSAIRE
SPAZIO NECESSARIO

Model	Dimensions (cm)	Required Space (cm)
KPEOV8059	800x400x150	1000x600x165
KPEOV7059	700x320x150	900x520x165
KPEOV6059	600x320x150	800x520x165
KPEOV5059	500x300x150	700x500x165

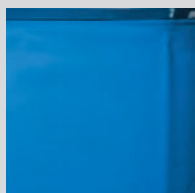

Liner PVC azul
75/100
PVC blue liner
75/100
Liner bleu PVC
75/100
Liner blu PVC
75/100

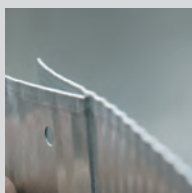

Chapa prelacada
70/100
Prelacquered
steel 70/100
Tôle prélaquée
70/100
Lamiera laccata
70/100

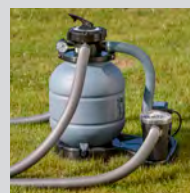

Depuradora arena
(Caudal grupo 10 m³/h)
Sand filter
(Flow group 10 m³/h)
Filtre à sable
(Débit groupe 10 m³/h)
Filtro a sabbia
(Portata gruppo 10 m³/h)



EAN 13

KPE4259	Ø420 cm	150 cm	18.840 l	126/224 kg	1/120x80 1/90x80	10m³/h	✓	8 412081 269351
---------	---------	--------	----------	------------	---------------------	--------	---	-----------------

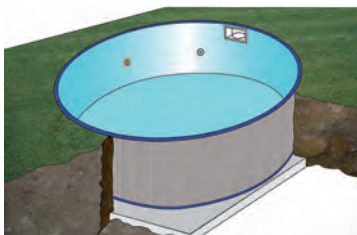

MEDIDA PISCINA
POOL SIZE
DIMENSIONS PISCINE
MISURA PISCINA

ESPACIO NECESARIO
NECESSARY SPACE
ESPACE NECESSAIRE
SPAZIO NECESSARIO

KPE4259	Ø420x150 cm	Ø620x165 cm
---------	-------------	-------------



Escalera:
4 peldaños - Inox.
Ladder:
4 steps - Stainless steel
Échelle: 4 marches -
Acier inoxydable
Scala:
4 gradini - Inox



Manta protectora
(Poliéster)
Bottom protectiveblanket
(Polyester)
Tapis de sol en feutre
(Polyester)
Telo di protezione
(Poliestere)



Skimmer, manguera,
racordería...
Skimmer, hose,
fittings...
Skimmer, tuyau,
raccords...
Skimmer, tubo,
racordería...

in-ground pool

serie **SUMATRA**

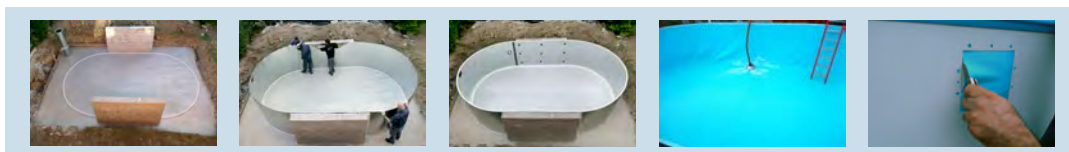

EAN 13

Model	Dimensions (cm)	Height (cm)	Capacity (l)	Weight (kg)	Box Dimensions (cm)	Flow Rate (m³/h)	Includes Ladder	EAN 13
KPEOV8027	800x400	120	30.000	193/222	1/120x80 1/90x80	10m³/h	✓	8 4 12081 269368
KPEOV7027	700x320	120	21.210	173/222	1/120x80 1/90x80	10m³/h	✓	8 4 12081 269375
KPEOV6027	600x320	120	17.850	154/222	1/120x80 1/90x80	10m³/h	✓	8 4 12081 269382
KPEOV5027	500x300	120	12.360	134/222	1/120x80 1/90x80	10m³/h	✓	8 4 12081 258959



MEDIDA PISCINA
POOL SIZE
DIMENSIONS PISCINE
MISURA PISCINA

ESPACIO NECESARIO
NECESSARY SPACE
ESPACE NECESSAIRE
SPAZIO NECESSARIO

Model	Dimensions (cm)	Necessary Space (cm)
KPEOV8027	800x400x120	1000x600x135
KPEOV7027	700x320x120	900x520x135
KPEOV6027	600x320x120	800x520x135
KPEOV5027	500x300x120	700x500x135

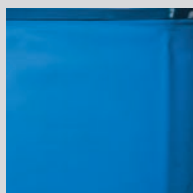

Liner PVC azul
60/100
PVC blue liner
60/100
Liner bleu PVC
60/100
Liner blu PVC
60/100

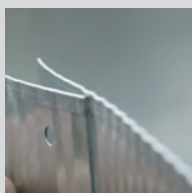

Chapa prelacada
60/100
Prelacquered
steel 60/100
Tôle prélaquée
60/100
Lamiera laccata
60/100

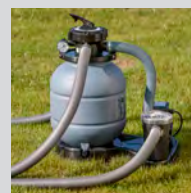

Depuradora arena
(Caudal grupo 10 m³/h)
Sand filter
(Flow group 10 m³/h)
Filtre à sable
(Débit groupe 10 m³/h)
Filtro a sabbia
(Portata gruppo 10 m³/h)



EAN 13

	Ø	Height	Capacity	Weight	Dimensions	Flow	Filter	EAN 13
KPE4227	Ø420 cm	120 cm	14.540 l	222/102 kg	1/120x80 1/90x80	10m³/h	✓	8 412081 269399
KPE3527	Ø350 cm	120 cm	10.102 l	222/85 kg	1/120x80 1/90x80	10m³/h	✓	8 412081 262635



MEDIDA PISCINA
POOL SIZE
DIMENSIONS PISCINE
MISURA PISCINA

ESPACIO NECESARIO
NECESSARY SPACE
ESPACE NECESSAIRE
SPAZIO NECESSARIO

	Pool Size	Necessary Space
KPE4227	Ø420x120 cm	Ø620x135 cm
KPE3527	Ø350x120 cm	Ø550x135 cm



Escalera:
3 peldaños - Inox.
Ladder:
3 steps - Stainless steel
Échelle: 3 marches -
Acier inoxydable
Scala:
3 gradini - Inox



Manta protectora
(Poliéster)
Bottom protectiveblanket
(Polyester)
Tapis de sol en feutre
(Polyester)
Telo di protezione
(Poliestere)



Skimmer, manguera,
raccordería...
Skimmer, hose,
fittings...
Skimmer, tuyau,
raccords...
Skimmer, tubo,
raccordería...

complements

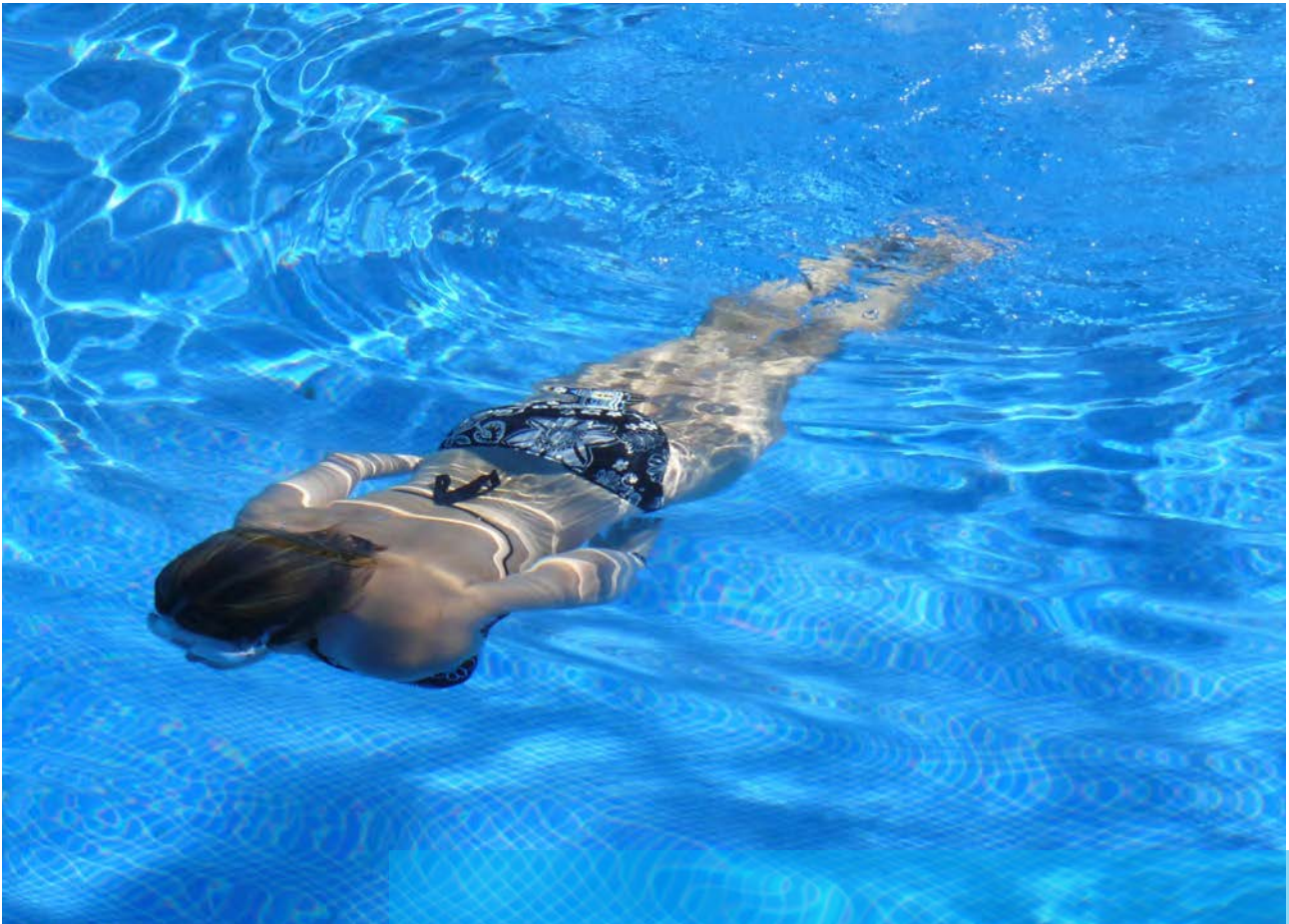

■ Leyenda ■ Legend ■ Légende ■ Legenda

BX

caja
box
box
scatola

BXL

caja con etiqueta
box and label
carton avec étiquette
scatola con etichetta

CB

cartoncillo
cardboard wrap
bande carton
cartone

PBH

bolsa de plástico con cartoncillo
polybag with header
sac plastique avec bande carton
sacchetto di plastica con cartone

BL

blister
blister
blister
blister

CS

doble burbuja
clamshell
double coque
doppio rivestimento

CBX

caja litografiada
colour box
boîte de couleur
scatola serigrafata

PB

bolsa de plástico
polybag
sac plastique
busta di plastica

DIS

display
display
display
display

complementos complements

COMPLEMENTOS	82	COMPLÉMENTS
Cubiertas isotérmicas para piscinas de madera	84	Wooden pool isothermic covers
Cubiertas de invierno para piscinas de madera	86	Wooden pool winter covers
Cubiertas isotérmicas para piscinas de composite	88	Composite pool isothermic covers
Cubiertas de invierno para piscinas de composite	88	Composite pool winter covers
Cubiertas isotérmicas para piscinas enterradas	89	In ground pool isothermic covers
Cubiertas isotérmicas	90	Isothermic covers
Cubiertas de invierno	91	Winter covers
Enrolladores de cubiertas	92	Telescopic cover rollers
Mantas	94	Bottom protective blankets
Protectores	95	Protectors
Liners	98	Liners
Reparadores de liner	104	Liner repairs
Deporte en la piscina	104	Pool Fitness
Seguridad piscina	105	Pool security
Escaleras para piscinas enterradas	106	Inground pool ladders
Escaleras para piscina de madera	107	Wooden pool ladder
Escaleras para piscinas sobre suelo	108	Above-ground pool ladders
Monoblocs de filtración	110	Filtration kit
Bombas	112	Pumps
Locales técnicos	114	Technical rooms
Cargas filtrantes	115	Filter media
Mangueras de filtración	116	Filtration hoses
Adaptadores	117	Adapters
Skimmers	118	Skimmers
Repuestos de filtración	118	Filtration spare parts
Filtros de Cartucho	121	Cartridge filter
Cartuchos	121	Cartridges
Blue Connect	122	Blue Connect
Electrolisis de sal	124	Electrolysis of salt
Sistemas de dosificación	125	Dosing systems
Iluminación	126	Lighting
Calefacción	130	Heating systems
Calefacción solar	133	Solar heating system
Duchas	134	Showers
Racordería	140	PVC Fittings

compléments complementi

COMPLÉMENTS	82	COMPLEMENTI
Bâches été pour piscines bois	84	Coperture isotermitiche per piscine in legno
Bâches hiver pour piscines bois	86	Copertura invernale per piscine in legno
Bâches été pour piscines composite	88	Coperture isotermitiche per piscine composite
Bâches hiver pour piscines composite	88	Copertura invernale per piscine composite
Bâches été pour piscines enterrées	89	Copertura isotermitiche per piscine interrata
Couvertures isothermes	90	Coperture isotermitiche
Couvertures d'hivernage	91	Copertura invernale
Enrouleurs de bâches	92	Avvolgiture
Tapis de sol	94	Telo di protezione fondi
Protecteurs	95	Protezioni
Liners	98	Liners
Réparation liner	104	Riparazione liner
Fitness piscine	104	Fitness in piscina
Protection pour piscine	105	Protezione per piscine
Échelles pour piscines enterrées	106	Scaletta per piscina interrata
Échelle pour piscines bois	107	Scaletta per piscina in legno
Échelles pour piscines hors sol	108	Scaletta per piscina fuori terra
Filtres a sable	110	Filtro monoblocco
Pompes	112	Pompe
Local technique	114	Locale tecnico
Médias filtrants	115	Carico filtrante
Tuyaux pour épurateurs	116	Tubi di filtraggio
Adaptateurs	117	Adattatori
Skimmers	118	Skimmers
Accessoires pour filtration	118	Filtraggio parti
Epurateurs à cartouche	121	Filtri a cartuccia
Cartouches	121	Cartucce
Blue Connect	122	Blue Connect
Electrolyse au sel	124	Elettrolisi salina
Système de dosage	125	Sistemi di dosaggio
Éclairage	126	Illuminazione
Chauffage	130	Riscaldamento
Chauffage solaire	133	Riscaldamento solare
Douches	134	Docce
Raccords PVC	140	Racorderia in PVC

■ complementos ■ complements

CUBIERTAS ISOTÉRMICAS PARA PISCINAS DE MADERA WOODEN POOL ISOTHERMIC COVERS BÂCHES ÉTÉ POUR PISCINES BOIS COPERTURE ISOTERMICHE PER PISCINE IN LEGNO



Material: Polietileno Material: Polyethylene
Matériau: Polyéthylène Materiale: Polietilene



EAN 13

786642	1157x366	400 µ	-	-	CARDAMON 788033	-	BXL pack 1	3605217866424
786641	960x366	400 µ	-	-	MINT 788032	-	BXL pack 1	3605217866417
786640	857x266	400 µ	-	-	ANISE 788031	-	BXL pack 1	3605217866400
CV790207	762x368	400 µ	-	-	BRAGA 790207	-	BXL pack 1	8412081308333
788922	748x347	400 µ	-	-	BRAGA 790095	-	BXL pack 1	3605217889225
N CV800009	480x368	400 µ	-	-	EVORA PLUS 800009	-	BXL pack 1	8412081313894
CV790206	565x368	400 µ	-	-	EVORA 790206	-	BXL pack 1	8412081308340
788921	547x347	400 µ	-	-	EVORA 790094	-	BXL pack 1	3605217889218
788453	374x224	400 µ	-	-	MARBELLA 790096	-	BXL pack 1	3605217884534
CVKPBR620	565x268	400 µ	-	-	MANGO KPBR620	-	BXL pack 1	8412081273501
CV790204	345x170	400 µ	-	-	LEMON 790204	-	BXL pack 1	8412081308296
CV790205	268x268	400 µ	-	-	-	CARRA 790205	BXL pack 1	8412081308302
788920	262x262	400 µ	-	-	-	CARRA 790093	BXL pack 1	3605217889201

■ compléments ■ complementi

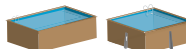

EAN 13

786637	889x539	400 µ	AVILA 790092	-	-	-	BXL pack 1	3605217866370
CV790208	800x403	400 µ	SEVILLA 790208	-	-	-	BXL pack 1	8412081308326
786636	818x418	400 µ	SEVILLA 790091	-	-	-	BXL pack 1	3605217866363
N CV800007	700x403	400 µ	ORANGE 800007	-	-	-	BXL pack 1	8412081313344
786634	618x418	400 µ	VERMELA 790098	-	-	-	BXL pack 1	3605217866349
CV790203	603x403	400 µ	AVOCADO 790203	-	-	-	BXL pack 1	8412081308289
784800	585x358	400 µ	SAFRAN 790089	-	-	-	BXL pack 1	3605217848000
779532	498x298	400 µ	CANELLE 790087	-	-	-	BXL pack 1	3605217795328
779530	398x298	400 µ	GRENADE 790086	-	-	-	BXL pack 1	3605217795304
790073	568x343	400 µ	CAMOMILLE 790202	-	-	-	BXL pack 1	3605217900739
CVKPBOC632	580x282	400 µ	MACADAMIA KPBOC632	-	-	-	BXL pack 1	8412081273488
CVKPBOC535	482x282	400 µ	BAMBU KPBOC535	-	-	-	BXL pack 1	8412081273471
784799	ø 452	400 µ	-	VIOLETTE 790085	-	-	BXL pack 1	3605217847997
N CV800003	ø 436	400 µ	-	VIOLETTE 2 800003	-	-	BXL pack 1	8412081313306
779524	ø 350	400 µ	-	VANILLE 790083	-	-	BXL pack 1	3605217795243
N CV800002	ø 337	400 µ	-	VANILLE 2 800002	-	-	BXL pack 1	8412081313276
787057	ø 250	400 µ	-	LILI 790080	-	-	BXL pack 1	3605217870575
N CV800008	ø 237	400 µ	-	LILI 2 800008	-	-	BXL pack 1	8412081313245
CV790210	ø 371	400 µ	-	ANANAS 790210	-	-	BXL pack 1	8412081308272

■ complementos ■ complements

CUBIERTAS DE INVIERNO PARA PISCINAS DE MADERA WOODEN POOL WINTER COVERS BÂCHES HIVER POUR PISCINES BOIS COPERTURE INVERNALE PER PISCINE IN LEGNO



Material: PVC armado
Material: Armed PVC
Matériau: PVC armé
Materiale: PVC armato



EAN 13

Code	Dimensions	Weight	Pool Shape	Pool Type	Model	Material	Package	EAN 13
778042	1258x467	580 g/m ²	-	-	CARDAMON 788033	-	BXL pack 1	3605217780423
778041	1058x467	580 g/m ²	-	-	MINT 788032	-	BXL pack 1	3605217780416
778040	958x367	580 g/m ²	-	-	ANISE 788031	-	BXL pack 1	3605217780409
CI790207	855x460	580 g/m ²	-	-	BRAGA 790207	-	BXL pack 1	8412081308425
788927	840x440	580 g/m ²	-	-	BRAGA 790095	-	BXL pack 1	3605217889270
CI790206	658x460	580 g/m ²	-	-	EVORA / EVORA PLUS 790206 / 800009	-	BXL pack 1	8412081308432
788926	640x440	580 g/m ²	-	-	EVORA 790094	-	BXL pack 1	3605217889263
788452	467x317	580 g/m ²	-	-	MARBELLA 790096	-	BXL pack 1	3605217884527
CIKPBRC620	658x360	580 g/m ²	-	-	MANGO KPBRC620	-	BXL pack 1	8412081273549
CI790204	414x239	580 g/m ²	-	-	LEMON 790204	-	BXL pack 1	8412081308388
CI790205	335x335	580 g/m ²	-	-	-	CARRA 790205	BXL pack 1	8412081308395
788925	330x330	580 g/m ²	-	-	-	CARRA 790093	BXL pack 1	3605217889256
790001	250x250	580 g/m ²	-	-	-	CITY 790000	BXL pack 1	3605217900012

■ compléments ■ complementi

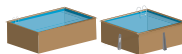

EAN 13

786639	982x632	580 g/m ²	AVILA 790092	-	-	-	BXL pack 1	3605217866394
CI790208	893x496	580 g/m ²	SEVILLA 790208	-	-	-	BXL pack 1	8412081308418
621104	912x512	580 g/m ²	SEVILLA 790091	-	-	-	BXL pack 1	3605216211041
N CI800007	793x496	580 g/m ²	ORANGE 800007	-	-	-	BXL pack 1	8412081313337
621103	712x512	580 g/m ²	VERMELA 790098	-	-	-	BXL pack 1	3605216211034
779537	676x451	580 g/m ²	SAFRAN 790089	-	-	-	BXL pack 1	3605217795373
786754	591x391	580 g/m ²	CANELLE 790087	-	-	-	BXL pack 1	3605217867544
779531	476x376	580 g/m ²	GRENADE 790086	-	-	-	BXL pack 1	3605217795311
CI790203	696x497	580 g/m ²	AVOCADO 790203	-	-	-	BXL pack 1	8412081308371
790063	661x436	580 g/m ²	CAMOMILLE 790202	-	-	-	BXL pack 1	3605217900630
CIKPBOC632	675x375	580 g/m ²	MACADAMIA KPBOC632	-	-	-	BXL pack 1	8412081273525
CIKPBOC535	575x375	580 g/m ²	BAMBU KPBOC535	-	-	-	BXL pack 1	8412081273518
784801	ø 550	580 g/m ²	-	VIOLETTE 2 800003 VIOLETTE 790085	-	-	BXL pack 1	3605217848017
779525	ø 440	580 g/m ²	-	VANILLE 2 800002 VANILLE 790083	-	-	BXL pack 1	3605217795250
787058	ø 325	580 g/m ²	-	LILI 2 800008 LILI 790080	-	-	BXL pack 1	3605217870582
CI790210	ø 468	580 g/m ²	-	ANANAS 790210	-	-	BXL pack 1	8412081308364

■ complementos ■ complements

CUBIERTAS ISOTÉRMICAS PARA PISCINAS DE COMPOSITE COMPOSITE POOL ISOTHERMIC COVERS BÂCHES ÉTÉ POUR PISCINES COMPOSITE COPERTURE ISOTERMICHE PER PISCINE COMPOSITE



Material: Polietileno
Material: Polyethylene
Matériau: Polyéthylène
Materiale: Polietilene



EAN 13

CVKPCOR60	560x280	400 µ	-	-	-	606x326	BXL pack 1	8 412081 273709 1
CVKPCOR46	420x280	400 µ	-	-	-	466x326	BXL pack 1	8 412081 304885 1
CVKPCOR2814	275x135	400 µ	-	-	-	326x186	BXL pack 1	8 412081 304977 1
CVKPCOR28	275x275	400 µ	-	-	326x326	-	BXL pack 1	8 412081 302690 1
CVKPCO80	753x333	400 µ	-	804x386	-	-	BXL pack 1	8 412081 270666 1
CVKPCO66	613x333	400 µ	-	664x386	-	-	BXL pack 1	8 412081 270654 1
CVKPCO52	473x333	400 µ	-	524x386	--	-	BXL pack 1	8 412081 270647 1
CVKPCO41	Ø 361	400 µ	Ø 410	-	-	-	BXL pack 1	8 412081 270630 1

CUBIERTAS DE INVIERNO PARA PISCINAS DE COMPOSITE COMPOSITE POOL WINTER COVERS BÂCHES HIVER POUR PISCINES COMPOSITE COPERTURE INVERNALI PER PISCINE COMPOSITE

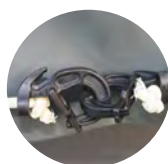

Material: PVC armado
Material: Armed PVC
Matériau: PVC armé
Materiale: PVC armato



EAN 13

CIKPCOR60	656x376	580 g/m ²	-	-	-	606x326	BXL pack 1	8 412081 273723 1
CIKPCOR46	516x376	580 g/m ²	-	-	-	466x326	BXL pack 1	8 412081 304892 1
CIKPCOR2814	376x236	580 g/m ²	-	-	-	326x186	BXL pack 1	8 412081 304984 1
CIKPCOR28	376x376	580 g/m ²	-	-	326x326	-	BXL pack 1	8 412081 302706 1
CIKPCO80	854x436	580 g/m ²	-	804x386	-	-	BXL pack 1	8 412081 270708 1
CIKPCO66	714x436	580 g/m ²	-	664x386	-	-	BXL pack 1	8 412081 270692 1
CIKPCO52	574x436	580 g/m ²	-	524x386	-	-	BXL pack 1	8 412081 270685 1
CIKPCO41	Ø 460	580 g/m ²	Ø 410	-	-	-	BXL pack 1	8 412081 270678 1

CUBIERTAS ISOTÉRMICAS PARA PISCINAS ENTERRADAS IN-GROUND POOLS
ISOTHERMIC COVERS BÂCHES ÉTÉ POUR PISCINES ENTERRÉES COPERTURE
ISOTERMICHE PER PISCINE INTERRATA



Material: Polietileno
 Material: Polyethylene
 Matériau: Polyéthylène
 Materiale: Polietilene



EAN 13

	CVPE800	795x395	400 µ	-	800x400	-	BXL pack 1	8 412081 273907
	CVPE700	695x315	400 µ	-	700x320	-	BXL pack 1	8 412081 273914
	CVPE600	595x315	400 µ	-	600x320	-	BXL pack 1	8 412081 273921
N	CVPE550	Ø 545	400 µ	Ø 550	-	-	BXL pack 1	8 412081 308449
	CVPE500	495x295	400 µ	-	500x300	-	BXL pack 1	8 412081 273938
	CVPE420	Ø 415	400 µ	Ø 420	-	-	BXL pack 1	8 412081 273945
N	CVPE350	Ø 345	400 µ	Ø 350	-	-	BXL pack 1	8 412081 273952
	CVPE300	Ø 295	400 µ	Ø 300	-	-	BXL pack 1	8 412081 308456
	CPERT105	995x495	180 µ	-	-	1000x500	BXL pack 1	8 412081 268354
	CPERT95	895x495	180 µ	-	-	900x500	BXL pack 1	8 412081 268347
	CPERT84	795x395	180 µ	-	-	800x400	BXL pack 1	8 412081 268330
	CPERT63	595x295	180 µ	-	-	600x300	BXL pack 1	8 412081 268323
	CPERT53	495x295	180 µ	-	-	500x300	BXL pack 1	8 412081 268316

■ complementos ■ complements

CUBIERTAS ISOTÉRMICAS ISOTHERMIC COVERS COUVERTURES ISOTHERMES COPERTURE ISOTHERMICHE

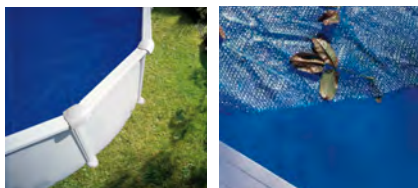

Material: Polietileno
Material: Polyethylene
Matériau: Polyéthylène
Materiale: Polietilene



EAN 13

CPROV1020	995x545	180 μ	-	1000x550	-	-	-	PBH pack 1	
CPROV915	910x460	180 μ	-	915x470	-	-	-	PBH pack 1	
CPROV810	805x460	180 μ	-	810x470	-	-	-	PBH pack 1	
CPROV730	725x370	180 μ	-	730x375	-	-	-	PBH pack 1	
CPROV610	605x370	180 μ	-	610x375	-	-	-	PBH pack 1	
CPROV510	485x335	180 μ	-	500x350	-	-	-	PBH pack 1	
CPROV505	495x295	180 μ	-	500x300	-	-	-	PBH pack 1	
CPROV700	672x445	180 μ	-	-	710x475	-	-	PBH pack 1	
CPROV600	620x370	180 μ	-	-	640x390	-	-	PBH pack 1	
CPROV500	472x305	180 μ	-	-	500x340	-	-	PBH pack 1	
CPR650	∅ 635	180 μ	-	-	-	∅ 640	-	PBH pack 1	
CPR550	∅ 545	180 μ	-	-	-	∅ 550	-	PBH pack 1	
CV450	∅ 455	180 μ	∅ 550	-	-	∅ 460	∅ 450/460	PBH pack 1	
CPR400	∅ 395	180 μ	-	-	-	-	∅ 400	PBH pack 1	
CV350	∅ 345	180 μ	∅ 450	-	-	∅ 350	∅ 350	PBH pack 1	
CV300	∅ 295	180 μ	∅ 350	-	-	∅ 300	∅ 300	PBH pack 1	
CV250	∅ 245	180 μ	∅ 300	-	-	∅ 240	-	PBH pack 1	
773326	725x370	400 μ	-	730x375	-	-	-	PBH pack 1	
773324	605x370	400 μ	-	610x375	-	-	-	PBH pack 1	
773322	485x335	400 μ	-	500x350	-	-	-	PBH pack 1	
773320	∅ 550	400 μ	∅ 555	-	-	∅ 550	-	PBH pack 1	
772999	∅ 460	400 μ	∅ 465	-	-	∅ 460	-	PBH pack 1	
772997	∅ 360	400 μ	∅ 365	-	-	∅ 360	-	PBH pack 1	
778899	∅ 300	400 μ	∅ 305	-	-	∅ 300	-	PBH pack 1	

CUBIERTAS DE INVIERNO WINTER COVERS
COUVERTURES POUR L'HIVER COPERTURA INVERNALE

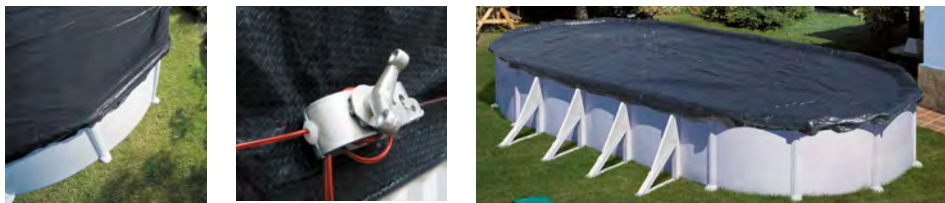

Material: Polietileno
 Material: Polyethylene
 Matériau: Polyéthylène
 Materiale: Polietilene



EAN 13

CIPROV731P	820x460	180 g/m ²	-	-	730x375	640x390	-	-	CBX pack 3	
CIPROV611P	680x460	180 g/m ²	-	-	610x375	500x340	-	-	CBX pack 3	
CIPROV501P	610x410	180 g/m ²	-	-	500x300	-	-	-	CBX pack 3	
CIPR451P	ø 540	180 g/m ²	-	ø 550	-	-	ø 460	ø 400	CBX pack 5	
CIPR351P	ø 440	180 g/m ²	-	ø 350 ø 360	-	-	ø 350	ø 350	CBX pack 5	
CIPROV1001	1115x660	120 g/m ²	-	-	1000x550	-	-	-	CBX pack 3	
CIPROV911	1030x560	120 g/m ²	-	-	915x470	-	-	-	CBX pack 3	
CIPROV821	930x560	120 g/m ²	-	-	800x470	710x475	-	-	CBX pack 3	
CIPROV731	820x460	120 g/m ²	-	-	730x375	640x390	-	-	CBX pack 3	
CIPROV611	680x460	120 g/m ²	-	-	610x375	500x340	-	-	CBX pack 3	
CIPROV501	610x410	120 g/m ²	-	-	500x300	-	-	-	CBX pack 3	
CIPR651	ø 730	120 g/m ²	-	-	-	-	ø 640	-	CBX pack 3	
CIPR551	ø 640	120 g/m ²	-	-	-	-	ø 550	-	CBX pack 5	
CIPR451	ø 540	120 g/m ²	-	ø 550	-	-	ø 460	ø 450 ø 460	CBX pack 5	
CIPR401	ø 480	120 g/m ²	ø 440	ø 450	-	-	-	ø 400	CBX pack 5	
CIPR351	ø 440	120 g/m ²	ø 360	ø 350 ø 360	-	-	ø 350	ø 350	CBX pack 5	
CIPR301	ø 380	120 g/m ²	-	-	-	-	ø 300	-	CBX pack 5	
CIPR241	ø 330	120 g/m ²	-	-	-	-	ø 240	-	CBX pack 5	

ENROLLADORES DE CUBIERTAS TELESCOPIC COVER ROLLERS ENROULEURS DE BÂCHES AVVOLGITORE PER PISCINE

REF. SCR55

BXL PACK 1



Enrollador de piscinas enterradas motorizado mediante energía solar

Tubos de aluminio.
Kit para fijarlo a la cubierta.
El sistema funciona con energía solar. Batería: 2000mA. Velocidad: 11 rpm. Voltaje: 12V
Energía solar: 12,6 V
Tubo telescópico en aluminio: 5,5 m. Confort de diseño. Ruedas para facilitar el transporte.

Enrouleur motorisé avec borne solaire pour piscines enterrées

Tubes en aluminium.
Kit de fixation pour bâche.
Alimentation du système à l'énergie solaire. Batterie : 2000 mA. Vitesse : 11 rpm. Voltage : 12 V
Énergie solaire : 12,6 V
Tube télescopique en aluminium : 5,5 m. Conception confortable. Roulettes incorporées pour faciliter le transport.

Motorized cover roller with solar energy for inground pools

Aluminium tubes.
Kit to attach it to the cover.
System works with solar energy. Battery: 2000mA. Speed: 11RPM. Voltage: 12V
Solar energy: 12,6 V
Telescopic tube in aluminium: 5,5 m. Comfort design. Wheels for easy transport.

Avvolgitore motorizzato ad energia solare per piscine interrate

Tubi in alluminio.
Kit per fissaggio alla copertura.
Dispositivo funzionante a energia solare. Batteria: 2000mA. Velocità: 11 RPM. Voltaggio: 12V
Energia solare: 12,6 V
Tubo telescopico in alluminio: 5,5 m. Design confortevole. Ruote per facilitare il trasporto.

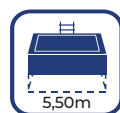

REF. 90171

BXL PACK 1



Enrollador piscinas enterradas

Enrollador de cubierta para piscinas enterradas. Ofrece un desarrollo máximo de 5,50m. Ideal para piscinas redondas, cuadradas u ovaladas. Contiene tubos redondos en aluminio anodizado, un volante ergonómico con empuñadura giratoria así como un kit para atar la cubierta.

Enrouleur pour piscines enterrées

Enrouleur de bâches pour piscines enterrées. Il offre un développement maximum de 5,50m. Il convient aux piscines rondes, carrées ou ovales. Il est équipé de tubes ronds en aluminium anodisés, d'un volant ergonomique avec poignée tournante et d'un kit d'attache pour bâche. Cet enrouleur est livré en un seul colis, packaging couleur.

Cover roller for inground pools

Winder cover for in ground pools. Unfolds to a maximum length of 5.50 m. Suitable for round, square or oval swimming pools. Includes round anodised aluminium tubes, an ergonomic hand wheel with revolving handle as well as a kit to attach it to the cover.

Avvolgitore per piscine interrate

Avvolgitore "grandi ruote" per piscine interrate. Si srotola fino a un massimo di 5.50m. Adatto per le piscine tonde, quadrate e ovali. Contiene un tubo in alluminio anodizzato, una ghiera ergonomica con una impugnatura rotatoria e un kit per fissare la copertura. Consegnato in un unico imballo.

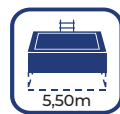

REF. 90172

BXL PACK 1



Enrollador de cubierta para piscinas enterradas

Ofrece un desarrollo máximo de 5,50m. Ideal para piscinas redondas, cuadradas u ovaladas. Contiene tubos redondos en aluminio, un volante ergonómico con empuñadura giratoria así como un kit para atar la cubierta.

Enrouleur de bâches pour piscines enterrées

Il offre un développement maximum de 5,50m. Il convient aux piscines rondes, carrées ou ovales. Il est équipé de tubes ronds en aluminium, d'un volant ergonomique avec poignée tournante et d'un kit d'attache pour bâche. Cet enrouleur est livré en un seul colis, packaging couleur.

Cover roller for inground pools

Unfolds to a maximum length of 5.50 m. Suitable for round, square or oval swimming pools. Includes round aluminium tubes, an ergonomic hand wheel with revolving handle as well as a kit to attach it to the cover.

Avvolgitore di coperture per piscine interrate

Si srotola fino a un massimo di 5.50m. Adatto per le piscine tonde, quadrate e ovali. Contiene un tubo in alluminio, una ghiera ergonomica con una impugnatura rotatoria e un kit per fissare la copertura. Consegnato in un unico imballo.

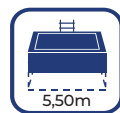



REF. CRP58

CBX PACK 1



Enrollador básico piscinas elevadas

Enrollador de cubiertas de verano hasta 5,8m de ancho. Tubo telescópico en aluminio. Para piscinas tubulares, de acero y madera. Fácil instalación.

Basic cover roller for above-ground pools

Cover roller for summer covers above ground pools up to 5,8 m wide. Telescopic tube in aluminium. For tubular, steel and wooden pools. Easy to install.



Enrouleur pour piscines hors-sol

Enrouleur de bâches été pour piscines jusqu'à 5,80m de largeur. Tubes télescopiques en aluminium. Il s'adapte aussi bien sur les piscines tubulaires que sur les piscines acier et bois. Facile à installer

Avvolgitore per piscine fuoriterra

Avvolgitore per coperture estive fino a 5,8 m di larghezza. Tubo telescopico in alluminio. Per piscine tubolari, d'acciaio e legno. Facile installazione.



REF. 40135

CBX PACK 2



Enrollador piscinas elevadas

El Enrollador ofrece un desarrollo máximo de 6,5m. Se ata fácilmente a las "playas" de la piscina con 2 placas atornilladas. El uso del enrollador permite una mejor conservación de la cubierta. Incluido: Conectores para piscinas tubulares.

Cover roller for above-ground pools

The Winder unfolds to a maximum length of 6.5 m. It can be easily attached to the "edge" finishing pieces of the pool using 2 bolted plates. The use of the winder enables a better conservation of the cover. Included: Connectors for tubular pools.

Enrouleur pour piscines hors-sol

Enrouleur offrant un développement maximum de 6,5m. Il se fixe facilement sur les 2 "margelles" de la piscine grâce à ses 2 plaques vissées. Les connecteurs pour piscines tubulaires sont inclus.

Avvolgitore per piscine fuoriterra

avvolgitore che si srotola fino a un massimo di 6.5 m. Si fissa facilmente al "bordo" della piscina con 2 placche con viti. L'utilizzo dell'avvolgitore permette una migliore conservazione della copertura.



REF. 621535

BXL PACK 1



Enrollador piscinas elevadas Luxe

Enrollador para piscina en superficie de longitud entre 2,44 y 6,32 m. Giro sobre el eje para descubrir la superficie de nado. Travesaño de resina Sistema de enganche compatible con todas las cubiertas de verano. Tubos telescópicos de aluminio. Cintas de enganche.

Luxe cover roller for above-ground pools

Roller for pool surface between 2.44 and 6.32 m long. It turns on its axis to reveal the swimming surface. Resin cross member. Hook system compatible with all the summer canvases. Telescopic aluminium tubes. Webbing loop.

Enrouleur pour piscines hors-sol Luxe

Enrouleur pour piscine hors sol d'une largeur de 2,44 à 6,32 m. Pivote sur un axe pour libérer la surface de nage. Piètement en résine. Système d'accroche compatible avec toutes les bâches été. Tubes télescopiques en aluminium. Sangles d'accrochage.

Avvolgitore per piscine fuori terra Luxe

Avvolgitore per piscine fuori terra di lunghezza compresa tra 2,44 e 6,32 m. Ruotare sull'asse per scoprire la superficie di balneazione. Traversa in resina. Sistema di aggancio compatibile con tutti i tessuti estivi. Tubi telescopici in alluminio. Cinghie di aggancio.



IMPORTANT: These cover rollers can not be placed in any composite pool. There is a risk of breakage. **IMPORTANTE:** Estos enrolladores no se pueden colocar en piscinas de composite, existe riesgo de rotura de las playas. **ATTENTION :** Cet enrouleur de bâches ne convient pas pour les piscines en composite. Il existe un risque de rupture des margelles. **IMPORTANTE:** Questo avvolgitore non si può installare in piscine in composite, esiste il rischio di rottura dei bordi piscina.

■ complementos ■ complements

MANTAS PROTECTORAS BOTTOM PROTECTIVE BLANKET POUR LE SOL DES PISCINES COUVERTURES DE PROTECTION DU FOND TAPPETO DI PROTEZIONE



Material: Poliéster
Material: Polyester
Matériau: Polyester
Materiale: Poliester



EAN 13

MPROV1100	1100x600	110 g/m ²	-	-	-	1000x550	-	-	-	PBH pack 1	
MPROV915	950x500	110 g/m ²	-	-	-	915x470	-	-	-	PBH pack 1	
MPROV810	825x500	110 g/m ²	780x400	-	780x400	810x470	710x475	-	-	PBH pack 1	
MPROV730	750x400	110 g/m ²	660x280	-	660x280	730x375	640x390	-	-	PBH pack 1	
MPROV610	625x400	110 g/m ²	530x280	-	530x280	610x375	500x340	-	-	PBH pack 1	
MPROV500	525x325	110 g/m ²	-	-	-	500x300	-	-	-	PBH pack 1	
MPR650	650x650	110 g/m ²	-	-	-	-	-	ø 640	-	PBH pack 1	
MPR550	550x550	110 g/m ²	-	-	ø 550	-	-	ø 550	-	PBH pack 1	
MPR450	450x450	110 g/m ²	-	ø 440	ø 450	-	-	ø 460 ø 450	ø 460	PBH pack 1	
MPR400	400x400	110 g/m ²	-	ø 360	-	-	-	ø 350 ø 400	ø 400	PBH pack 1	
MPR350	350x350	110 g/m ²	-	-	ø 350	-	-	ø 350 ø 300	ø 350	PBH pack 1	
MPR250	250x250	110 g/m ²	-	-	ø 240	-	-	ø 240	-	PBH pack 1	

Delta MS®
REF. 772060

BXL PACK 1

20 x 1,5m



PROTECTOR DE PARED

Rollo de protección y de drenaje alveolar de PEAD (polietileno de alta densidad) para piscina de madera (20x1,5m)
1- Pared de piscina de madera
2- Rollo de protección y de drenaje alveolar de PEAD

WALL PROTECTOR

Protection and alveolar draining roll of HDPE (High Density Polyethylene) for wooden pool (20x1,5m)
1- Wood frame
2- Roll of alveolar protection an drainage of HDPE

ROULEAU DE PROTECTION

Pour piscine bois
Rouleau de protection et de drainage alvéolaire en PEHD (polyéthylène haute densité) (20x1,5m)
1- Ossature bois
2- Nappe à excroissances type Delta MS®

PROTEZIONE PER PARETE

Rotolo di protezione del drenaggio alveolare di HDPE (polietilene ad alta densità) per piscina in legno (20x1,5m)
1- Struttura in legno
2- Rotolo di protezione del drenaggio alveolare di HDPE

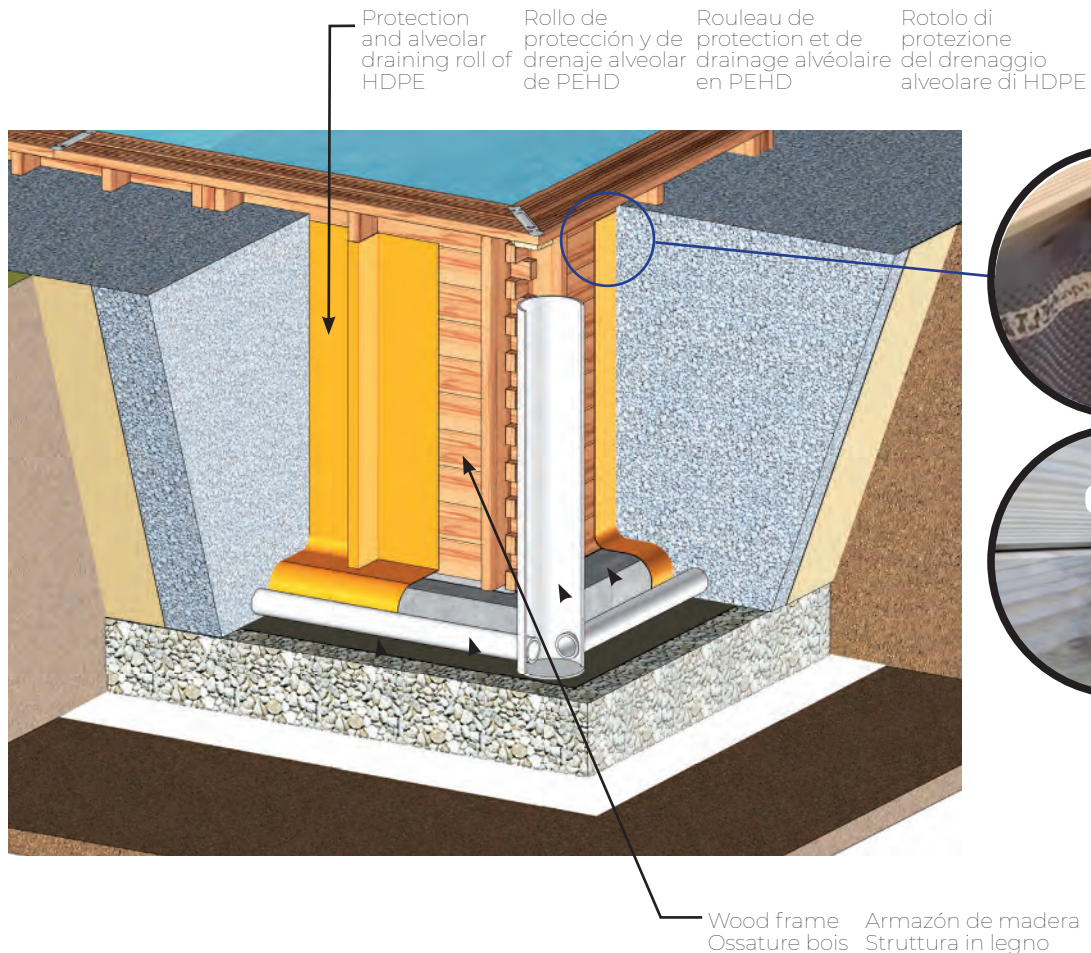
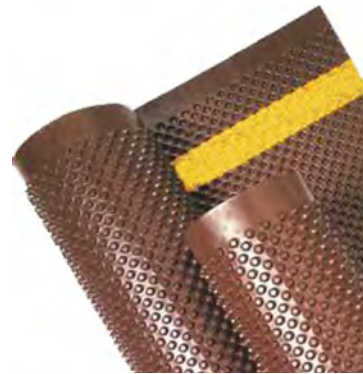

PROTECTORES PROTECTORS PROTECTEURS PROTEZIONE



FLOOR PROTECTOR - SPECIAL SPA

REF. MPF509GY PB PACK 8 50x50cmx8mm 8 412081 302638



PROTECTOR DE SUELO DE PISCINA ANTIDESLIZANTE

Material duradero (Etilvinilacetato (EVA))
Ofrece una protección adicional para el fondo de la piscina. Contiene 9 piezas de 50x50cm = 2,25m²
Espesor= 8mm.

NON SLEPPERY POOL FLOOR PROTECTOR

Durable material (Ethylene-vinyl acetate (EVA)).
Provides added protection for pool floors. Package contains 9 pieces of 50x50cm= 2,25m²
Thickness = 8mm.

PROTECTEUR DE SOL DE PISCINE ANTIDÉRAPANT

Matériau durable (Éthylène-acétate de vinyle (EVA)).
Fournit une protection supplémentaire pour le sol des piscines. L'emballage contient 9 pièces 50x50cm = 2,25m² Épaisseur= 8mm.

PROTEZIONE PER IL FONDO DELLA PISCINA ANTISKID

In materiale resistente (Etilene vinil acetato (EVA)).
Evita che il fondo della piscina si danneggi.
Il package include 9 pezzi, 50x50cm = 2,25m²
Spessore = 8 mm.

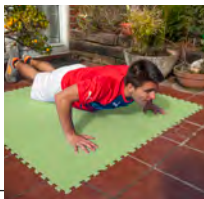

FLOOR PROTECTOR

REF. MPF819 PB PACK 7 81x81cmx4,5mm 8 412081 268361



PROTECTOR DE SUELO DE PISCINA

Material duradero (Etilvinilacetato (EVA))
Ofrece una protección adicional para el fondo de la piscina. Contiene 9 piezas de 81x81cm = 5,90m²

POOL FLOOR PROTECTOR

Durable material (Ethylene-vinyl acetate (EVA)). Provides added protection for pool floors. Package contains 9 pieces of 81x81cm = 5,90m²

PROTECTEUR DE SOL DE PISCINE

Matériau durable (Éthylène-acétate de vinyle (EVA))
Fournit une protection supplémentaire pour le sol des piscines.
L'emballage contient 9 pièces 81x81cm = 5,90m²

PROTEZIONE PER IL FONDO DELLA PISCINA

In materiale resistente (Etilene vinil acetato (EVA))
Evita che il fondo della piscina si danneggi
Il package include 9 pezzi, 81x81cm = 5,90m²

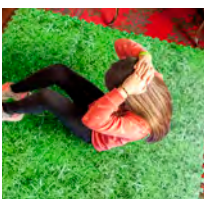

FLOOR PROTECTOR

REF. MPF509GR PB PACK 8 50x50cmx8mm 8 412081 268521



PROTECTOR DE SUELO DE PISCINA ANTIDESLIZANTE

Material duradero (Etilvinilacetato (EVA))
Ofrece una protección adicional para el fondo de la piscina. Contiene 9 piezas de 50x50cm = 2,25m²
Espesor= 8mm.

NON SLEPPERY POOL FLOOR PROTECTOR

Durable material (Ethylene-vinyl acetate (EVA))
Provides added protection for pool floors. Package contains 9 pieces of 50x50cm= 2,25m²
Thickness = 8mm.

PROTECTEUR DE SOL DE PISCINE ANTIDÉRAPANT

Matériau durable (Éthylène-acétate de vinyle (EVA))
Fournit une protection supplémentaire pour le sol des piscines. L'emballage contient 9 pièces 50x50cm = 2,25m² Épaisseur= 8mm.

PROTEZIONE PER IL FONDO DELLA PISCINA ANTISKID

In materiale resistente (Etilene vinil acetato (EVA))
Evita che il fondo della piscina si danneggi. Il package include 9 pezzi, 50x50cm = 2,25m²
Spessore = 8 mm.

FLOOR PROTECTOR

REF. MPF509P

PB PACK 8 50x50cmx8mm



PROTECTOR DE SUELO DE PISCINA ANTIDESLIZANTE

Material duradero (Etilvinilacetato (EVA)) Ofrece una protección adicional para el fondo de la piscina. Contiene 9 piezas de 50x50cm = 2,25m² Espesor= 8mm.

PROTECTEUR DE SOL DE PISCINE ANTIDÉRAPANT

Matériau durable (Éthylène-acétate de vinyle (EVA)) Fournit une protection supplémentaire pour le sol des piscines. L'emballage contient 9 pièces 50x50cm = 2,25m². Épaisseur= 8mm.

NON SLEPPERY POOL FLOOR PROTECTOR

Durable material (Ethylene-vinyl acetate (EVA)) Provides added protection for pool floors. Package contains 9 pieces of 50x50 = 2,25m² Thickness = 8mm.

PROTEZIONE PER IL FONDO DELLA PISCINA ANTISKID

In materiale resistente (Etilene vinil acetato (EVA)) Evita che il fondo della piscina si danneggi. Il package include 9 pezzi, 50x50cm = 2,25m² Spessore = 8 mm.

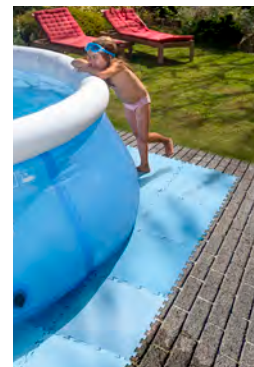
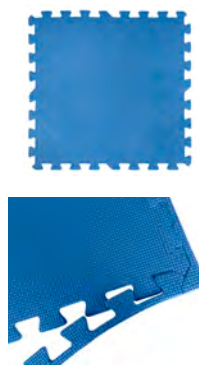

FLOOR PROTECTOR

REF. MPF509

PB PACK 14 50x50cmx4,5mm



PROTECTOR DE SUELO DE PISCINA

Material duradero (Etilvinilacetato (EVA)) Ofrece una protección adicional para el fondo de la piscina. Contiene 9 piezas de 50x50cm = 2,25m²

PROTECTEUR DE SOL DE PISCINE

Matériau durable (Éthylène-acétate de vinyle (EVA)) Fournit une protection supplémentaire pour le sol des piscines. L'emballage contient 9 pièces 50x50cm = 2,25m²

POOL FLOOR PROTECTOR

Durable material (Ethylene-vinyl acetate (EVA)) Provides added protection for pool floors. Package contains 9 pieces of 50x50 = 2,25m²

PROTEZIONE PER IL FONDO DELLA PISCINA

In materiale resistente (Etilene vinil acetato (EVA)) Evita che il fondo della piscina si danneggi. Il package include 9 pezzi, 50x50cm = 2,25m²



BOX MPF509

REF. MPF509BOX60

PB PACK 60 50x50cmx4,5mm



BOX PROTECTOR DE SUELO DE PISCINA

Material duradero (Etilvinilacetato (EVA)) El box contiene 60 unidades

BOX PROTECTEUR DE SOL DE PISCINE

Matériau durable (Éthylène-acétate de vinyle (EVA)). Le box contient 60 unités.

BOX POOL FLOOR PROTECTOR

Durable material (Ethylene-vinyl acetate (EVA)). Box contains 60 units

BOX PROTEZIONE PER IL FONDO DELLA PISCINA

In materiale resistente (Etilene vinil acetato (EVA)). Il box include 60 unità



■ complementos ■ complements

LINERS PARA PISCINA DE MADERA WOODEN POOL LINERS LINERS POUR PISCINES BOIS LINERS PER PISCINE IN LEGNO



Liner azul
Blue liner
Liner bleu
Liner blu



Liner beige
Beige liner
Liner beige
Liner beige

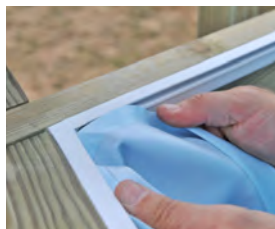

(BD)
Sistema beaded
Beaded system
Système d'accrochage
Hung
Sistema beaded



EAN 13

786337	●	75/100	AVILA 790092	-	-	-	3605217863379
786219	●	75/100	AVILA 790092	-	-	-	3605217862198
786336	●	75/100	SEVILLA 790091	-	-	-	3605217863362
786218	●	75/100	SEVILLA 790091	-	-	-	3605217862181
F790207	●	75/100	-	-	BRAGA 790207	-	8412081308241
786334	●	75/100	VERMELA 790098	-	-	-	3605217863348
786217	●	75/100	VERMELA 790098	-	-	-	3605217862174
N F800007	●	75/100	ORANGE 800007	-	-	-	8412081313320
F790206	●	75/100	-	-	EVORA 790206	-	8412081308258
783809	●	75/100	SAFRAN 790089	-	-	-	3605217838094
786216	●	75/100	SAFRAN 790089	-	-	-	3605217862167
778768	●	60/100	CANELLE 790087	-	-	-	3605217787682
786215	●	60/100	CANELLE 790087	-	-	-	3605217862150
F790053C	●	60/100	CAMOMILLE 790202	-	-	-	3605217873170
F790203	●	75/100	AVOCADO 790203	-	-	-	8412081308197
F790204	●	50/100	-	-	LEMON 790204	-	8412081308203
N F800003	●	75/100	-	VIOLETTE 2 800003	-	-	8412081313290

■ compléments ■ complementi



EAN 13

		75/100	-	VIOLETTE 790085	-	-	3605217838858
		75/100	-	VIOLETTE 790085	-	-	3605217862143
		60/100	GRENADE 790086	-	-	-	3605217787675
		75/100	-	ANANAS 790210	-	-	8412081308180
		75/100	-	-	MARBELLA 790096	-	3605217859457
		50/100	-	VANILLE 790083	-	-	3605217862136
		75/100	SEVILLA 790208	-	-	-	8412081308234
		60/100	-	-	-	CARRA 790205	8412081308210
		60/100	-	-	-	CARRA 790093	3605217880444
		50/100	-	VANILLE 2 800002	-	-	8412081313269
		50/100	-	VANILLE 790083	-	-	3605217786890
		50/100	-	-	-	CITY 790000	3605217880451
		50/100	-	LILI 2 800008	-	-	8412081313238
		50/100	-	LILI 790080	-	-	3605217863409
		75/100	-	-	EVORA PLUS 800009	-	8412081313887
		75/100	-	-	BRAGA 790095	-	3605217859433
		75/100	BOGOTA 790088	-	-	-	3605217885692
		75/100	-	-	EVORA 790094	-	3605217859396
		60/100	-	-	MANGO KPBR620	-	3605217859495
		60/100	MACADAMIA KPBOC632	-	-	-	3605217859518
		60/100	BAMBÚ KPBOC535	-	-	-	3605217859501

■ complementos ■ complements

LINERS PARA PISCINA DE COMPOSITE COMPOSITE POOL LINERS LINERS POUR PISCINES COMPOSITE LINERS PER PISCINE COMPOSITE



(BD)
Sistema beaded
Beaded system
Système d'accrochage Hung
Sistema beaded

Liner gris
Grey liner
Liner gris
Liner grigio



EAN 13

SPCO80G	●	804 x 386 cm	124 cm	60/100	BD	8412081267234
SPCO66G	●	664 x 386 cm	124 cm	60/100	BD	8412081267227
N SPCO6650G	●	664 x 386 cm	154 cm	60/100	BD	8412081315591
SPCO52G	●	524 x 386 cm	124 cm	60/100	BD	8412081267210
SPCOR60G	●	606 x 326 cm	124 cm	60/100	BD	8412081267197
SPCOR46G	●	466 x 326 cm	124 cm	60/100	BD	3612820002200
SPCO41G	●	Ø 410 cm	124 cm	60/100	BD	8412081267203
SPCOR28G	●	326 x 326 cm	96 cm	60/100	BD	8412081267180
SPCOR2814G	●	326 x 186 cm	96 cm	60/100	BD	3612820002477

LINERS PARA PISCINA DE ACERO STEEL WALL POOL LINERS
LINERS POUR PISCINES PAROI ACIER LINERS PER PISCINE CON
PARETI IN ACCIAIO



Liner azul
Blue liner
Liner bleu
Liner blu

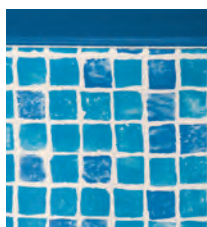

Liner gresite
Ceramics liner
Liner carrelage
Liner mosaicato



(SC)
Sistema colgante
Hanging system
Système d'accroche
Con barra di
agganciamento



(OV)
Sistema overlap
Overlap system
Système à
recouvrement
Sistema overlap

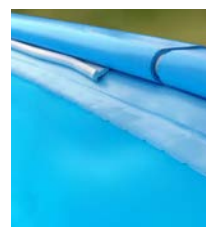

(BD*)
Sistema beaded
Beaded system
Système
d'accrochage
Hung
Sistema beaded

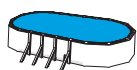

EAN 13

		1000 x 550 cm	132 cm	40/100	SC	8412081224169
		915 x 470 cm	132 cm	50/100	SC	8412081258195
		915 x 470 cm	132 cm	40/100	SC	8412081214511
		915 x 470 cm	120 cm	40/100	SC	8412081980270
		800 x 470 cm	132 cm	50/100	SC	8412081258201
		800 x 470 cm	132 cm	40/100	SC	8412081224091
		800 x 470 cm	120 cm	40/100	SC	8412081206059
		800 x 400 cm	150 cm	75/100	BD	8420382775976
		800 x 400 cm	120 cm	60/100	BD	8412081274249
		730 x 375 cm	132 cm	50/100	SC	8412081258218
		730 x 375 cm	132 cm	40/100	SC	8412081224107
		730 x 375 cm	120 cm	40/100	SC	8412081980287
		730 x 375 cm	120 cm	40/100	OV	8412081237879
		730 x 375 cm	120 cm	75/100	OV	3605217703996
		700 x 320 cm	150 cm	75/100	BD	8420382775969
		700 x 320 cm	120 cm	60/100	BD	8412081274225
		610 x 375 cm	132 cm	50/100	SC	8412081258225
		610 x 375 cm	132 cm	40/100	SC	8412081224114

* Solo para piscinas enterradas *Only for inground pools *Uniquement pour piscines enterrées * Solo per piscine interrata

■ complementos ■ complements

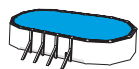

EAN 13

		FPROV610	610 x 375 cm	120 cm	40/100	SC	8412081206066
		FSPROV610	610 x 375 cm	120 cm	40/100	OV	8412081237824
		773486	610 x 370 cm	120 cm	75/100	OV	3605217734860
N		PROV6012FE	600 x 320 cm	150 cm	75/100	BD	8420382775952
N		PROV6013FE	600 x 320 cm	120 cm	60/100	BD	8420382775921
N		PROV5112FE	500 x 300 cm	150 cm	75/100	BD	8412081247632
		FPROV517	500 x 300 cm	132 cm	50/100	SC	8412081258232
N		PROV5113FE	500 x 300 cm	120 cm	60/100	BD	8412081247731
		FPROV500	500 x 300 cm	120 cm	40/100	SC	8412081221878
		FSPROV500	500 x 300 cm	120 cm	30/100	OV	8412081237831

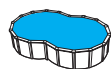

EAN 13

		FPROV707	700 x 450 cm	120 cm	40/100	SC	8412081204338
N		SP507F	500 x 340 cm	120 cm	40/100	OV	8412081253046
		FPROV627	625 x 375 cm	120 cm	40/100	SC	8412081204345
N		SP627F	625 x 375 cm	120 cm	40/100	OV	8412081253091
		FPROV507	500 x 340 cm	120 cm	40/100	SC	8412081204352



EAN 13

		FPR557	ø 550 cm	132 cm	50/100	SC	8412081258249
		FPR558	ø 550 cm	132 cm	40/100	SC	8412081214504
		FPR551	ø 550 cm	120 cm	40/100	SC	8412081950648
N		PR5513FE	ø 550 cm	120 cm	60/100	BD	8412081248127
		770398	ø 460 cm	120 cm	75/100	OV	3605217703989
		FPR457	ø 460 cm	132 cm	50/100	SC	8412081258256

■ compléments ■ complementi



EAN 13

		ø 460 cm	132 cm	40/100	SC	8412081224121
		ø 460 cm	120 cm	40/100	SC	8412081980485
N		ø 460 cm	130 cm	40/100	OV	8412081252933
N		ø 420 cm	150 cm	75/100	BD	8412081274256
N		ø 420 cm	120 cm	60/100	BD	8420382775983
		ø 460 cm	120 cm	30/100	OV	8412081237848
		ø 450 cm	90 cm	20/100	OV	8412081990217
		ø 400 cm	90 cm	20/100	OV	8412081990224
N		ø 400 cm	90 cm	20/100	OV	8412081216393
		ø 350 cm	132 cm	50/100	SC	8412081258263
N		ø 350 cm	120 cm	60/100	BD	8412081247717
		ø 350 cm	132 cm	40/100	SC	8412081233918
		ø 350 cm	120 cm	40/100	SC	8412081200576
N		ø 350 cm	130 cm	40/100	OV	8412081252889
		ø 350 cm	90 cm	30/100	SC	8412081201177
N		ø 350 cm	90 cm	20/100	OV	8412081216355
N		ø 350 cm	120 cm	30/100	OV	8412081237855
		ø 350 cm	90 cm	20/100	OV	8412081990231
		ø 300 cm	120 cm	40/100	SC	8412081216027
N		ø 300 cm	120 cm	60/100	BD	8412081315287
N		ø 300 cm	120 cm	40/100	OV	8412081252858
		ø 300 cm	90 cm	20/100	OV	8412081203249
N		ø 300 cm	90 cm	20/100	OV	8412081264004
		ø 300 cm	65 cm	20/100	OV	8412081201191
		ø 240 cm	120 cm	40/100	SC	8412081203010

■ complementos ■ complements

REPARADORES DE LINER LINER REPAIR RÉPARATION LINER RIPARAZIONE LINER

REF. 40080

BL PACK 24 DIS



Kit reparación liner Liner repair kit
Kit de réparation pour liner Kit riparazione liner



REF. VI2

BL PACK 50



Kit reparador de PVC PVC repair kit
Kit de réparation PVC Kit per riparazioni PVC



REF. AR202

BL PACK 96



Film reparador de PVC PVC repair film
Film de réparation PVC Pellicola per riparare i liner



DEPORTE EN LA PISCINA POOL FITNESS FITNESS PISCINE FITNESS IN PISCINA

AQUABIKE

REF. AQB2

CBX PACK 1



BICICLETA ACUÁTICA

Una nueva forma de hacer ejercicio en bicicleta cuando estás en la piscina. Concebido para todo tipo de piscinas. Sillín anatómico - Manillar deportivo - Ruedas antiarañazos - Pedales anatómicos con resistencia ajustable.

VÉLO DE PISCINE

Une nouvelle façon de faire de l'exercice à vélo lorsque vous êtes dans la piscine. Conçu pour tous les types de piscine. Selle anatomique - guidon sportif - roues anti-rayures pour un transport facile - Pédales anatomiques avec résistance réglable.

WATER BIKE

A new way of exercising by cycling when you are in the pool. Conceived for all type of pools. Anatomic saddle - Sporting handle bar - Anti scratch wheels - Anatomic pedals with adjustable resistance.

BICICLETTA ACQUATICA

Un nuovo modo di allenarsi in bici quando si è in piscina. Progettato per tutti i tipi di piscine. Sellino anatomico - manubrio sportivo - ruote antigraffio per facilitare il trasporto - Pedali anatomici con resistenza regolabile.

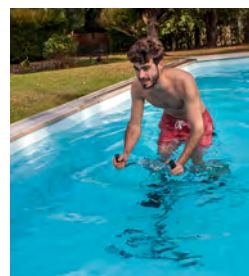

SEGURIDAD PISCINA POOL SECURITY

EQUIPEMENTS DE SÉCURITÉ POUR PISCINE PROTEZIONE PER PISCINE

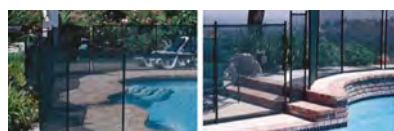

REF. SF133

CBX PACK 1



8 412081 308159

Barrera de protección para piscinas.

Módulo premontado. Longitud adaptable. Adaptable a diferentes formas de piscina. Módulo de 3 m de uso individual. Altura de la barrera: 1,33 m. Tejido efecto transparente que permite una visibilidad excelente de la piscina.

Barrière de protection pour piscine.

Module pré-monté. Adaptable en longueur pour répondre à toutes les configurations. Module de 3m à usage individuel. Hauteur de la barrière : 1,33m. Toile effet «transparent» qui permet une excellente visibilité du bassin. Conforme à la norme NF P 90-306

Safety fence for swimming pool.

Ready to install. Adjustable in length to answer all configurations. 3 m module for individual use. Fence height : 1,33m. Transparent net witch allows an excellent visibility of the swimming pool.

Barriera di protezione per piscina.

Modulo pre installato. Lunghezza adattabile in base alle forme della piscina. Modulo di 3m ad uso individuale. Altezza della barriera: 1,33 m. Tessuto effetto trasparente che permetta una visibilità eccellente della vasca.

REF. 770270

CBX PACK 1



3 605217 702708



Alarma de piscina

Vigilancia máxima. Detector de inmersión certificado DE CONFORMIDAD con la norma NF P90 307/A1 por el LNE. Sin activación imprevista. Se coloca en modo vigilancia automática 15 minutos después del baño. Información permanente sobre el estado de la vigilancia.

Alarme de piscine

Surveillance maxi. Détecteur d'immersion certifié CONFORME à la norme NF P90 307/A1 par le LNE. Aucun déclenchement intempestif. Remise en surveillance maximale 15 minutes après la baignade. Information permanente sur l'état de surveillance.

Pool alarm

Maximum surveillance. Immersion detector with CONFORMITY certificate with the NF P90 307/A1 Standard by LNE. Without unexpected activation. Automatically enters into surveillance mode 15 minutes after the last use of the pool. Permanent information about the surveillance status.

Allarme per piscina

Massimo livello di vigilanza. Rilevatore di immersione certificato IN CONFORMITÀ con la normativa NF P90 307/A1 dell'LNE. Senza attivazione imprevista. Si posiziona in modalità di vigilanza automatica 15 minuti dopo l'utilizzo della piscina. Informazioni permanente sullo stato di vigilanza.



■ complementos ■ complements

ESCALERAS PARA PISCINA ENTERRADA INGROUND POOL LADDERS
ÉCHELLES POUR PISCINES ENTERRÉES SCALETTA PER PISCINA INTERRATA



REF. EIE30 BXL PACK 1



Escalera acero inoxidable
 AISI304 para piscina
 enterrada
 3 peldaños dobles

AISI304 Stainless steel
 inground pool
 ladder
 3 double steps

Échelle acier inoxydable
 AISI304 pour piscine
 enterrée
 3 marches double

Scaletta Inox AISI304 per
 piscina interrata
 3 gradini doppi



Ref. EPE30 BXL PACK 1



Escalera sintética para
 piscinas enterradas
 4 peldaños

Easy access synthetic ladder
 for in ground pools
 4 steps

Échelle synthétique
 d'entrée facile pour piscine
 enterrée
 4 marches

Scaletta sintetica per
 piscina interrata
 4 gradini



STANDARD
REF. 40272 BXL PACK 1



Escalera STANDARD para piscina
 enterrada de 4 peldaños Inox.

Stainless steel STANDARD
 inground pool ladder - 4 steps.

Échelle modèle STANDARD acier
 inoxydable pour piscine enterrée
 - 4 marches

Scaletta STANDARD per
 piscina
 interrata da 4 gradini - Inox



STANDARD
REF. 40110 BXL PACK 1



Escalera STANDARD
 para piscina enterrada
 de 3 peldaños Inox.

Stainless steel STANDARD
 inground pool ladder - 3
 steps.

Échelle modèle STANDARD acier
 inoxydable pour piscine enterrée
 - 3 marches

Scaletta STANDARD per
 piscina
 interrata da 3 gradini - Inox

WALL

REF. 40274

BXL PACK 1



8 412081 250779

Escalera MURO para piscina enterrada de 4 peldaños – Inox

Stainless steel inground pool WALL ladder - 4 steps

Échelle MURALE acier inoxydable pour piscine enterrée - 4 marches

Scaletta MURO per piscina interrata da 4 gradini – Inox



WALL

REF. 40273

BXL PACK 1



8 412081 250786

Escalera MURO para piscina enterrada de 3 peldaños – Inox

Stainless steel inground pool WALL ladder - 3 steps

Échelle MURALE acier inoxydable pour piscine enterrée - 3 marches

Scaletta MURO per piscina interrata da 3 gradini – Inox



ESCALERA PARA PISCINA DE MADERA WOODEN POOL LADDER
ECHELLES POUR PISCINES BOIS SCALETTA PER PISCINE IN LEGNO

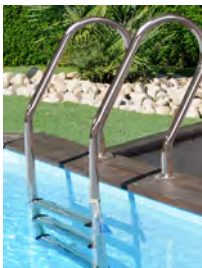

Ref. 126674

CBX PACK 1



3 605211 266749

Escalera de acero inoxidable partida
 3 peldaños antideslizantes
 Para piscinas de madera

Split stainless steel ladder
 3 non-slip steps
 For wooden pools

Échelle en acier inoxydable à 2 éléments.
 3 marches antidérapantes.
 Pour piscines en bois.

Scaletta in acciaio inox a due elementi
 3 gradini antiscivolo
 Per piscine in legno



■ complementos ■ complements

ESCALERAS PARA PISCINA SOBRE SUELO ABOVE-GROUND POOL LADDERS
ÉCHELLES POUR PISCINES HORS SOL SCALETTA PER PISCINA FUORI TERRA

NEW
2021



120cm
132cm

SAFETY
REF. L4PL

BXL PACK 1



8 412081 312798

Escalera moldeada por soplado
2x4 peldaños + plataforma

Blow molded ladder
2x4 steps + platform

Échelle moulée par soufflage
2x4 marches + plateforme

Scaletta stampata a soffiaggio
2x4 gradini + piattaforma



120cm
132cm

SAFETY
REF. ES1213

BXL PACK 1



8 412081 302768

Escalera de seguridad
2x3 peldaños + plataforma

Safety ladder
2x3 steps + platform

Échelle sécurité 134cm
2x3 marches + plateforme

Scala di sicurezza
2x3 gradini + piattaforma



120cm
132cm

REF. ET1213

BXL PACK 1



8 412081 302775

Escalera
2x3 peldaños + plataforma

Ladder
2x3 steps + platform

Échelle
2x3 marches + plateforme

Scala
2x3 gradini + piattaforma

INOX

REF. AR11680 BXL PACK 1



8 412081 231082

Escalera de acero inoxidable 142cm
2x4 peldaños + plataforma

Stainless steel ladder 142cm
2x4 steps + platform

Échelle acier inoxydable 142cm
2x4 marches + plateforme

Scala in acciaio inossidabile 142cm
2x4 gradini + piattaforma



STANDARD

REF. AR109 BXL PACK 1



8 412081 980522

Escalera tipo tijera 98cm
2x2 peldaños

Ladder 98cm
2x2 steps

Échelle 98cm
2x2 marches

Scala 98cm
2x2 gradini



SPA LADDER

REF. SPAL2 BXL PACK 1



8 412081 302935

Escalera para SPA
2 peldaños

SPA Ladder
2 steps

Marche pied pour SPA
2 marches

Scala per SPA
2 gradini

70x65x34cm



■ complementos ■ complements

FILTROS DE ARENA SAND FILTERS FILTRE A SABLE FILTRO A SABBIA

Las impurezas quedan retenidas en el medio filtrante en el interior de la cuba. Son muy compactos, fáciles de instalar, utilizar y no requieren especial atención. Gracias a su válvula selectora (5/6 vías dependiendo del modelo), permiten realizar diferentes funciones: autolimpiado, filtración, vaciado... Los filtros FA6100 / FS550 / FS500 / FS400 / FS320 incorporan un prefiltro para retener las partículas excesivamente grandes y evitar dañar la bomba y están certificados con la norma europea EN 16713-1:2015 que garantiza que cumple con las normativas de seguridad establecidas.

Les impuretés sont retenues dans le média filtrant à l'intérieur de la cuve. Ces filtres sont très compacts et très faciles à installer et à utiliser. Ils ne nécessitent pas d'attention particulière. Sa vanne multivoie (5/6 voies, suivant le modèle), permet de réaliser diverses fonctions: auto nettoyage, filtrage, vidange... Les filtres FA6100 / FS550 / FS500 / FS400 / FS320 sont certifiés par la norme européenne EN 16713-1:2015 garantissant qu'ils respectent les réglementations établies en matière de sécurité. Le filtre est muni d'un pré filtre qui retient les particules excessivement grandes pour éviter d'endommager la pompe.

Impurities are held by the filter media inside the tank. Sand filters are compact sized, easy to install and use and special care is not required. Thanks to their multiport valves (5/6 ways depending on the version), different functions can be carried out: self-cleaning, filtration, emptying... Filters FA6100 / FS550 / FS500 / FS400 / FS320 are certified with the standard europe EN 16713-1:2015 ensuring that they comply with the safety regulations set. They include a prefilter to hold the largest particles to prevent pump from any damage.

Le impurità rimangono intrappolate nelle carico filtrante all'interno del cestello. Sono molto compatti, facili da installare e da utilizzare e non richiedono cure particolari. . Grazie alla valvola selettiva della quale sono dotati (5/6/7 uscite a seconda del modello), consentono diverse funzioni: autopulizia, filtrazione, svuotamento... Il filtri FA6100 / FS550 / FS500 / FS400 / FS320 sono certificati dalla normativa europea EN 16713-1:2015 che garantisce la loro conformità alle normative di sicurezza vigenti. Sono composti da un prefilter per trattenere le particelle eccessivamente grandi ed evitare il danneggiamento della pompa.

Filtro independiente soplado top Independent top blow molded filters

Filtre à sable soufflé en vanne top Filtro soffiato top con valvola superiore



REF.
FIS600









REF.
FIS500



REF.
FIS400



EAN 13

					EAN 13
FIS600	Ø 600 mm	±150 kg	6	CBX pack 1	 8 412081 305011
FIS500	Ø 500 mm	±85 kg	6	CBX pack 1	 8 142081 305004
FIS400	Ø 400 mm	±40 kg	6	CBX pack 1	 8 412081 304991



Kits de filtración Filtration kits
Kits de filtration Kit di filtrazione



REF. FA6100



REF. FS500



REF. FS550



REF. FS400



REF. FS320



REF. FS320NP



W

HP



EAN 13

			W	HP				EAN 13
FA6100	∅ 600 mm	10.000 l/h	485 W	0,66 CV/HP	±130 kg	6	BXL pack 1	8 4 12081 233857
FS550	∅ 500 mm	10.000 l/h	800 W	1 CV/HP	±85 kg	6	CBX pack 1	8 4 12081 307053
FS500	∅ 500 mm	8.000 l/h	550 W	0,75 CV/HP	±85 kg	5	CBX pack 1	8 4 12081 252339
FS400	∅ 400 mm	6.000 l/h	230 W	0,31 CV/HP	±40 kg	5	CBX pack 1	8 4 12081 252322
FS320	∅ 320 mm	4.000 l/h	180 W	0,24 CV/HP	±20 kg	5	CBX pack 1	8 4 12081 303406
FS320NP	∅ 320 mm	4.000 l/h	180 W	0,24 CV/HP	±20 kg	5	CBX pack 1	8 4 12081 308906

■ complementos ■ complements

BOMBAS PUMPS POMPES DE FILTRATION POMPE

Gama de bombas autoaspirantes GRE con potencias comprendidas entre 1/3 CV y 2 CV. Se trata de bombas centrifugas de una sola etapa, autocebantes, concebidas para uso con un sistema de filtración de piscina.

The self-priming pump range GRE emits power between 1/3 CV and 2 CV. Centrifugal pumps are single stage, self-priming pumps designed for use in a swimming pool filtration systems.

Gamme de pompes auto-aspirantes de la marque GRE, avec des puissances comprises entre 1/3 CV et 2 CV. Il s'agit de pompes centrifuges, auto-amorçantes, conçues pour une utilisation avec un système de filtration de piscine.

Gamma di pompe autoaspiranti GRE con potenze comprese tra 1/3 CV e 2 CV. Si tratta di pompe centrifughe monostadio, autoadescanti, concepite per l'uso con un sistema di filtrazione per piscina.

PREMIUM

- Ref. PP201 CBX PACK 1
- Ref. PP151 CBX PACK 1
- Ref. PP101 CBX PACK 1
- Ref. PP076H CBX PACK 1



Curvas de rendimiento hidráulico
Hydraulic performance curves
Courbes de performances hydrauliques
Curve delle prestazioni idrauliche

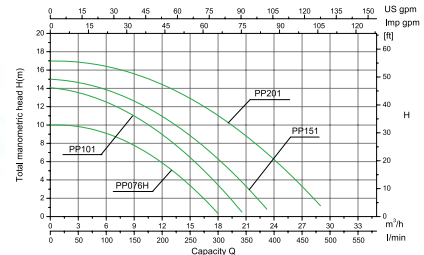

COMFORT

- Ref. PP076 CBX PACK 1
- Ref. PP051 CBX PACK 1
- Ref. PP031 CBX PACK 1



Curvas de rendimiento hidráulico
Hydraulic performance curves
Courbes de performances hydrauliques
Curve delle prestazioni idrauliche

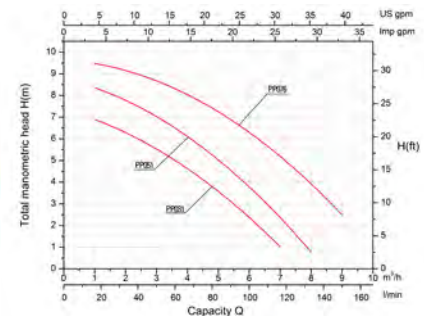

HP

W



EAN 13

Model	HP	W	Flow Rate (l/h)	Capacity (m ³)	Ø (mm)	EAN 13
PP201	2 CV/HP	1600 W	27.000 l/h	170m ³	Ø 800 mm	8 412081 269535
PP151	1,5 CV/HP	1100 W	22.000 l/h	135m ³	Ø 700 mm	8 412081 269542
PP101	1 CV/HP	900 W	20.000 l/h	100m ³	Ø 600 mm	8 412081 269559
PP076H	3/4 CV/HP	600 W	17.000 l/h	65m ³	Ø 500 mm	8 412081 302737
PP076	3/4 CV/HP	550 W	9.500 l/h	65m ³	Ø 500 mm	8 412081 269566
PP051	1/2 CV/HP	450 W	8.500 l/h	50m ³	Ø 400 mm	8 412081 269573
PP031	1/3 CV/HP	250 W	7.000 l/h	35m ³	Ø 300 mm	8 412081 269580

■ compléments ■ complementi



FILTRO AQUALOON

REF. FAQ200

CBX PACK 1



8 412081 272542

FILTRO AQUALOON
Tangue 200 mm. Caudal:
4m³/h. Filtra cualquier residuo
hasta 3 micras.
Conexiones 32 y 38 mm.
Incluye 320g de AquaLoon

AQUALOON FILTER
200 mm tank. Flow rate:
4m³/h. Filters any residue
until 3 micron.
32 and 38 mm connections.
Include 320g AquaLoon

FILTRE AQUALOON
Cuve 200 mm. Débit 4m³/h.
Filtre n'importe quel résidu
jusqu'à 3 microns. Embouts
soudés 32 et 38 mm.
Comprend 320g AquaLoon

SISTEMA FILTRANTE
Filtro 200 mm. Portata
4m³/h.
Filtra qualsiasi residuo fino a
3 micron
Raccordi 32 e 38 mm.
Include 320g di AquaLoon



FILTRO AQUALOON

REF. CFAQ35

CBX PACK 1



8 412081 302621

FILTRO DE CARTUCHO CON
AQUALOON
Caudal: 3,5m³/h.
Filtra cualquier residuo hasta 3
micras. Conexiones 32 y 38 mm.
Incluye 70g de AquaLoon

CARTRIDGE FILTER
WITH AQUALOON
Flow rate: 3,5m³/h.
Filters any residue until 3
micron.
32 and 38 mm connections.
Include 70g AquaLoon

EPURATEUR À CARTOUCHE
AVEC AQUALOON
Débit 3,5m³/h.
Filtre n'importe quel résidu
jusqu'à 3 microns. Embouts
soudés 32 et 38 mm.
Comprend 70g AquaLoon

FILTRI A CARTUCCIA
Portata 3,5m³/h.
Filtra qualsiasi residuo fino
a 3 micron
Raccordi 32 e 38 mm.
Include 70g di AquaLoon



CARTUCHO AQUALOON

REF. CAQ70

CBX PACK 12



8 412081 272566

Cartucho AquaLoon tipo A
Cartouche AquaLoon de type A

Type A AquaLoon cartidge
Cartuccia AquaLoon tipo A

MEDIOS FILTRANTES FILTER MEDIA MÉDIAS FILTRANTS CARICO FILTRO



FILTRO AQUALOON

REF. AQ700

CBX PACK 36



8 412081 268484

REF. AQ700B

CBX PACK 12



8 412081 302911

MEDIO FILTRANTE
700gr de AQUALOON = 25kg
de ARENA
Filtra cualquier residuo hasta
3 micras
Polietileno 100% reciclable

FILTER MEDIA
700gr AQUALOON = 25kg
SAND. Filters any residue up
to 3 microns
Polyethylene 100% recyclable

Medias filtrants
700g d'AQUALOON = 25kg de
SABLE
Filtre n'importe quel résidu
jusqu'à 3 microns
Polyéthylène 100% recyclable

SISTEMA FILTRANTE
700gr de AQUALOON = 25kg
de ARENA
Filtra qualsiasi residuo fino a 3
micron
Polietilene riciclabile al
100%

AQ700

LOCALES TÉCNICOS TECHNICAL ROOMS
LOCAL TECHNIQUE LOCALE TECNICO



DESIGNED,
MACHINED
AND
ASSEMBLED
IN EU



**WOODEN
TECHNICAL ROOM**

BXL PACK 1

LOCAL TÉCNICO

Pino silvestre autoclave clase III. Paneles pre-ensamblados para montaje por usted mismo. Para todos los tipos de piscinas. Abertura superior mediante trampilla. Para adosar a la piscina o a una pared (con fondo). L. 100 x a. 88 cm - 3 alturas disponibles.

TECHNICAL ROOM

Autoclave class III pine. Pre-assembled panels for you to assemble yourself. For all types of swimming pools. Top opening through a flap. To fit to a pool or to a wall (with a base). L. 100 x h 88 cm - 3 heights available.

LOCAL TECHNIQUE

En pin Sylvestre autoclave classe III. Panneaux pré-assemblés, à monter soi même. Pour tous types de piscine. Ouverture sur le dessus par une trappe. À adosser à la piscine ou à un mur (avec fond). L. 100 x l. 88 cm - 3 hauteurs disponibles.

LOCALE TECNICO

Pino silvestre trattamento in autoclave classe III. Pannelli pre-assemblati che è possibile montare da soli. Per tutti i tipi di piscina. Apertura superiore mediante botola. Da appoggiare alla piscina o a una parete (con fondo). L. 100 x a. 88 cm - 3 altezze disponibili.

Ref. 787247
H. 118cm



3 605217 872470

Ref. 787248
H. 131cm



3 605217 872487

Ref. 787249
H. 143cm



3 605217 872494



DESIGNED,
MACHINED
AND
ASSEMBLED
IN EU



**COMPOSITE
TECHNICAL ROOM**

BXL PACK 1

LOCAL TÉCNICO

Local técnico para piscinas de composite en paneles premontados. Cadenado incluido (para la seguridad de los niños). Mismo diseño y acabado que las piscinas de composite. L. 80 x a. 60 cm - 2 alturas disponibles.

TECHNICAL ROOM

Composite technical room which consists of pre-mounted panels. A lock is included (as childrens security). Same design and finish as the composite pools. L. 80 x h 60 cm - 2 heights available.

LOCAL TECHNIQUE

Local technique pour piscines en composite et panneaux pré-montés. Cadenas inclus (pour la sécurité des enfants). Même style et finition que les piscines en composite. L. 80 x l. 60 cm - 2 hauteurs disponibles.

LOCALE TECNICO

Locale tecnico per piscine in materiale composito a pannelli premontati. Lucchetto incluso (per la sicurezza dei bambini). Design e finitura identiche a quelle della piscina in materiale composito. L. 80 x a. 60 cm - 2 altezze disponibili.



Ref. TRCP96
H. 89cm



8 412081 312712

Ref. TRCP124
H. 115cm



8 412081 302713

MEDIOS FILTRANTES FILTER MEDIA
MÉDIAS FILTRANTS CARICO FILTRO



REF. AR200

PB PACK 1
 PALET 40U.



Arena - Silex 25kg.
 Granulometria 0,4-0,8.

Sand - Silex 25 kg.
 Grain size 0,4-0,8.

Sable - Silex 25kg.
 Granulométrie 0,4-0,8.

Sabbia - Silex 25kg.
 Granulometria 0,4-0,8.



REF. VF025

PB PACK 1
 PALET 40U.



Vidrio filtrante saco 25kg
 Granulometria 0,5 - 1 mm

Glass filter media 25 kg
 Grain size 0,5 - 1 mm

Verre filtrant 25kg
 Granulométrie 0,5 - 1 mm

Vetro filtrante 25kg
 Granulometria 0,5 - 1 mm



Ref. 622564

Palette de 48 sacs



Sable pour Filtration Sac de sable - 25 Kg

Origine France
 Granulométrie : 0,5 à 2 mm
 Sable séché

Remplir la cuve au 3/4 maximum
 Compatible avec tout type de produits de
 traitement de l'eau, y compris la floculation.
 Il est conseillé de renouveler le sable tous les 3 ans

Référence exclusive pour la France

■ complementos ■ complements

MANGUERAS DE FILTRACIÓN FILTRATION HOSES TUYAUX POUR ÉPURATEURS TUBI DI FILTRAZIONE

Kit mangueras filtración Filtration hoses kit
 Kit tuyaux pour épurateurs Kit tubi di filtraggio
 2 (Ø38mm x 4,5m) + 1 (Ø38mm x 1,5m) + 1 (Ø38mm x 0,68m)
 + 1 (Ø38mm x 0,58m) + 1 (Ø38mm x 0,40m)
 + 7 abrazaderas / clamps / colliers / fascette

REF. AR2100

BX PACK 1



8 4 120 81 202518



Manguera seccionable Sectionable hose
 Tuyau sectionnable Tubo sezionabile
36,5m - Ø38mm

REF. 90160

BX PACK 1



8 4 273 70 901607

36,5m - Ø32mm

REF. 90161

BX PACK 1



8 4 273 70 901614



Manguera para filtro 4m con 2 terminales Filter hose 4m with 2 cuffs
 Tuyau pour filtration 4m avec 2 embouts Tubo filtrante 4m con 2 terminali

Ø38mm

REF. 40180

BX pack 1



8 4 273 70 401800

Ø32mm

REF. 40181

BX pack 1



8 4 273 70 401817



Manguera de conexión Connection hose
 Tuyau de jonction Tubo di giunzione

68 cm - Ø38mm

REF. 60222

PB pack 10



8 4 273 70 602221

58 cm - Ø38mm

REF. 60218

PB pack 10



8 4 273 70 602184

36 cm - Ø38mm

REF. 60205

PB pack 10



8 4 273 70 602054

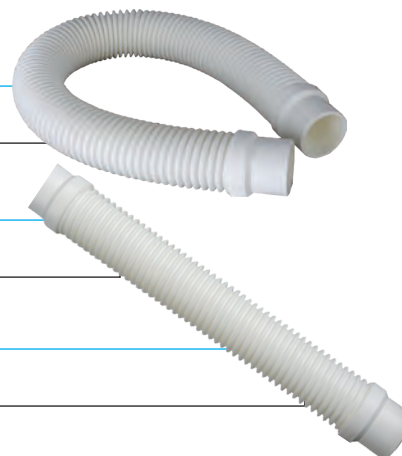

ADAPTADORES ADAPTERS
ADAPTEURS ADATTATORI



Adaptador de mangueras Ø32/38mm Ø32/38mm hose bard adaptor
Embout cannelé pour tuyau Ø32/38mm Adattatore per tubo Ø32/38mm

REF. 778196

BX PACK 12



3 605217 781963



Quitavuelas para manguera Ø38mm Ø38mm hose adaptor with threaded connection
Raccord tournant pour tuyaux Ø38mm Adattatore per tubo Ø38mm

REF. 40091

BX PACK 12



8 427370 400919



2 conectores Ø38 + 4 abrazaderas Ø38 2 connectors Ø38 + 4 clamps Ø38
2 manchons pour branchement tuyaux Ø38 + 4 colliers Ø38 2 raccordi Ø38 + 4 fascette Ø38

REF. AR509

CS pack 10



8 412081 209685



2 conectores Ø38/32 + 4 abrazaderas Ø38/Ø32 2 connectors Ø38/32 + 4 clamps Ø38/Ø32
2 manchons pour branchement tuyaux Ø38/32 + 4 colliers Ø38/Ø32 2 raccordi Ø38/32 + 4 fascette Ø38/Ø32

REF. AR511

CS pack 10



8 412081 215792

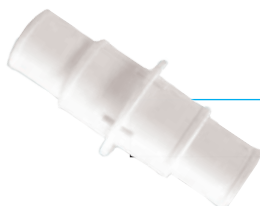

Unión 2 mangueras flotantes Ø38mm y 32mm 2 vacuum hoses union Ø38mm and 32mm
Liaison pour tuyaux flottants Ø38mm et 32mm Raccordo per unire 2 tubi Ø32mm - 38mm

REF. 40009

DIS PACK 12



8 427370 400994



Adaptador de mangueras 38/32mm 38/32mm hose adapter
Adaptateur de tuyaux Ø38/32mm Adattatore per tubo 32/38mm

REF. 40095

BX PACK 12



8 427370 400957

■ complementos ■ complements

SKIMMERS PARA PISCINAS DE ACERO STEEL WALL POOLS SKIMMERS SKIMMERS POUR PISCINES AVEC PAROIS EN ACIER SKIMMERS PER PISCINA IN ACCIAIO



REF. AR100 BXL PACK 1 8 412081 950396

Skimmer + boquilla de impulsión
Skimmer + buse de refoulement

Skimmer + return fitting
Skimmer + bocchetta



REF. AR100W BXL PACK 1 8 412081 233192

Skimmer + boquilla de impulsión
Skimmer + buse de refoulement

Skimmer + return fitting
Skimmer + bocchetta



REF. AR100G BXL PACK 1 8 432611 769083

Skimmer + boquilla de impulsión
Skimmer + buse de refoulement

Skimmer + return fitting
Skimmer + bocchetta

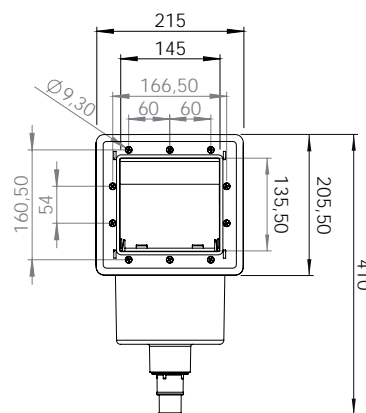

REPUESTOS DE FILTRACIÓN FILTRATION SPARE PARTS ACCESSOIRES POUR FILTRATION RICAMBI PER FILTRAZIONE



REF. AR500 CS PACK 6 8 412081 206462

Cesto para skimmer
Skimmer Basket
Panier pour skimmer
Cesto prefiltro
Ø ext. 16,2 cm #5,5 cm Ø int. 11 cm



REF. AR501 CS PACK 6 8 412081 206486

Compuerta para skimmer
Weir for skimmer
Volet pour skimmer
Sportellino
12 x 14,5 x 2 cm



REF. AR502 CS PACK 6 8 412081 206493

Junta doble skimmer
Skimmer layer
Joint pour skimmer
Giunto doppio di stagno
ext. 20,5 x 19,5 x 0,5 cm
int. 14,8 x 13,9 x 0,5 cm



REF. AR521 CS PACK 12 8 412081 250748

Junta doble skimmer + 2
juntas de válvula de retorno
Double seal for skimmer + 2
seals for return valve
Joint double skimmer + 2 joints
pour buse de refoulement
Guarnizione doppia standard
Skimmer + 2 guarnizioni per la
valvola di ritorno



REF. AR503
CS PACK 6 8 412081 206509

Boquilla de impulsión
Return fitting
Buse de refoulement
Valvola di impulsione completa

REF. AR505
CS PACK 8 8 412081 208619



Tapa para conexión de manguera limpiafondos
Lid for connecting the vacuum hose to the skimmer
Couvercle pour relier le tuyau flottant au skimmer
Adattatore per puliscifondo



REF. AR506
CS PACK 8 8 412081 208602

Manómetro
Pressure gauge
Manomètre
Manometro



REF. AR508
CS PACK 6 8 412081 208589

Zuncho universal
Filter ring
Collier de fixation
Ghiera filtro



REF. AR512
CS PACK 12 8 412081 221601

Válvula apertura/cierre
Ø38-Ø32
Open/close valve Ø38-Ø32
Vanne ouverture/fermeture
Ø38-Ø32
Valvola di apertura/chisura
Ø38-Ø32



REF. 621702
CBX PACK 12 3 605216 217029

Válvula cuarto de vuelta
¼ Turn valve
Vanne ¼ de tour
Valvola ¼ di giro



REF. AR510
CS PACK 24 8 412081 215785

Cintaflón y 4 abrazaderas
Cintaflon and 4 clamps
Teflon et 4 colliers
Nastro Teflon e 4 fascette



REF. WFL6
DIS pack 12 8 412081 264424

Esponjas absorbentes de grasa - 6 unidades
Grease absorbing sponge for skimmer - 6 units
Eponges absorbantes de residus gras - 6 unités
Spugne che assorbe e trattiene le sostanze grasse - 6 unità

■ complementos ■ complements

SKIMMER UNIVERSAL UNIVERSAL SKIMMER SKIMMER UNIVERSEL SKIMMER UNIVERSAL

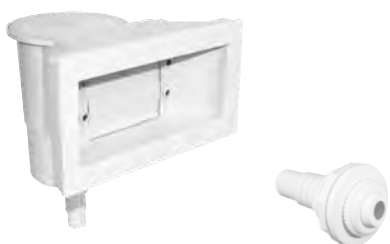

Ref. 778200

BXL PACK 1



Skimmer de boca ancha para piscina de madera + boquilla de impulsión

Wide mouth skimmer for wooden Pool + return valve

Ensemble skimmer grande ouverture pour piscines bois + buse de refoulement

Skimmer bocca larga piscina Madera + valvola di ritorno



Ref. 778198

BXL PACK 1



Skimmer universal + boquilla de impulsión

Universal Skimmer + return valve

Ensemble skimmer petite ouverture universel + buse de refoulement

Skimmer universale + valvola di ritorno



Ref. 778193

CS PACK 12



Compuerta para skimmer
Weir for skimmer
Volet pour skimmer
Sportellino



Ref. 625028

CB PACK 12



Tapa para skimmer
Cover for skimmer
Couvercle pour skimmer
Lid per skimmer



Ref. 778194

CS PACK 6



Cesto para skimmer
Skimmer Basket
Panier pour skimmer
Cesto prefiltro
Dim. Ext. Ø16cm / Int. Ø12 cm - H,7,5 cm



Ref. 770359

CB PACK 12



Tapa para conexión de manguera limpiafondos
Lid for connecting the vacuum hose to the skimmer
Couvercle pour relier le tuyau flottant au skimmer
Adattatore per puliscifondo
Ø 32/38 mm



Ref. FSK10

DIS pack 12



Filtros de skimmer con velcro
Prefiltres jetables de skimmer avec velcro.
Pre-filter fabric bag for use in skimmer using velcro
Filtri di skimmer con velcro
10 u.



Ref. 40045

CS PACK 12



10 filtros de skimmer
10 filter savers
10 filtres pour skimmer
10 filtri di skimmer

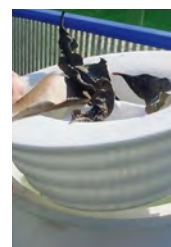

FILTROS DE CARTUCHO CARTRIDGE FILTER EPURATEURS À CARTOUCHE FILTRI A CARTUCCIA

Están especialmente concebidos para piscinas con un volumen de agua medio-inferior. Son muy sencillos de utilizar y su mantenimiento se limita a la limpieza o sustitución del cartucho o filtro de recambio, cuando éste ha quedado obstruido por la excesiva carga de suciedad.

Ils sont spécialement conçus pour les piscines avec un volume d'eau moyen inférieur. Ils sont très faciles à utiliser et l'entretien se limite au nettoyage ou au remplacement de la cartouche ou du filtre, quand il est bouché par un excès de saletés.

Specially designed for medium-low water volume pools. Cartridge filters are very easy to use and their maintenance is limited to the cartridge cleaning or replacement when dirt is blocking it.

Pensati specialmente per piscine con un volume di acqua medio-basso. Sono molto semplici da usare e la manutenzione si limita alla pulizia o sostituzione della cartuccia o della cartuccia di ricambio, quando questa è ostruita da eccessive impurità.



REF. AR125



REF. AR124
REF. AR121E



W



EAN 13

AR125	3.800 l/h	70 W	AR82	BXL pack 1	8 412081 970318
AR124	3.800 l/h	70 W	AR82	BXL pack 1	8 412081 203164
AR121E	2.000 l/h	72 W	AR86	BXL pack 1	8 412081 210193

CARTUCHOS CARTRIDGES CARTOUCHES CARTUCCIA



REF. AR79

Cartouche de type A pour piscine autoportante

Type A Cartridge inflatable pool

Cartouche de type A piscine autoportante

Cartuccia tipo A piscina autoportante



REF. AR86

Cartucho
Cartouche

Cartridge
Cartuccia



EAN 13

AR86	AR121/118	CS pack 12	8 412081 203409
AR82	AR125/124/118	CS pack 12	8 412081 970325
AR89	AR11806	CS pack 12	8 412081 217017
AR79	Type A	PB pack 18	8 412081 241708

■ complementos ■ complements

ANALIZADOR INTELIGENTE PARA LA PISCINA SMART POOL ANALYSER ANALYSEUR INTELLIGENT POUR LA PISCINE ANALIZZATORE INTELLIGENTE PER PISCINA

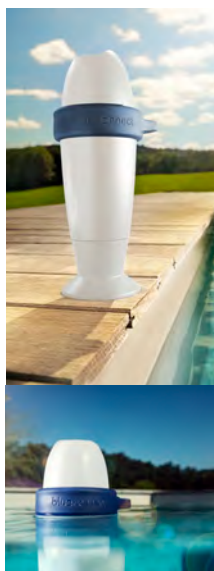

blueconnect Go

REF. 73014 CBX PACK 1



Sensor innovador todo en uno
Mide los principales parámetros de la piscina: Temperatura, pH, Nivel desinfectante (ORP).

Innovative all-in-one sensor
Measure main parameters of pools: Temperature, pH, Disinfectant level (ORP).

Capteur innovant tout en un
Mesure les principaux paramètres de la piscine: température, pH, niveau de désinfectant (ORP).

Innovativo sensore tutto in uno
Misura i principali parametri della piscina: Temperatura, pH, livello disinfettante (ORP).

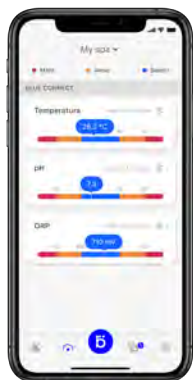
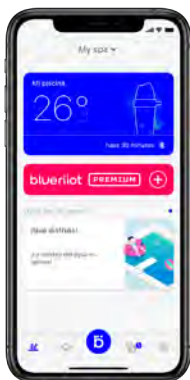

1

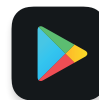

Descarga la App
Téléchargez l'application

Download the App
Scarica l'App

2



Enlaza con **Blue Connect**
Connectez la au Blue Connect

Link **Blue Connect**
Connetti **Blue Connect**

3



Sumérgelo en el agua
Installez-le dans l'eau

Sumérgelo en el agua
Installa nell'acqua

■ compléments ■ complementi

REF.
7015C001
BXL PACK 1



Batería para el Blue Connect.
Batería de litio de cloruro de tionilo.
Battery for the Blue Connect.
Lithium thionyl chloride battery.
Batterie pour le Blue Connect.
Batterie en lithium-chlorure de thionyle.
Batteria per il Blue Connect.
Batteria al litio cloruro di tionile

REF.
7015R001
BXL PACK 1



Blue Sensor es un sensor compatible con Blue Connect con vida útil de 2 temporadas
Blue Sensor is compatible with Blue Connect with a useful life of 2 seasons
Blue Sensor est un capteur compatible avec le Blue Connect dont la durée de vie est de 2 saisons.
Blue Sensor è un sensore compatibile con Blue Connect con vita utile pari a 2 stagioni

REF.
7015R002
BXL PACK 1



Blue Sensor Au (oro) especial electrólisis.
Blue Sensor Au (gold) special for salt chlorinator.
Blue Sensor Au spécial pour électrolyse au sel
Blue Sensor Au (oro) speciale per elettrolisi salina

REF.
7015C004
BXL PACK 1



Puente wifi bluetooth
Bluetooth WiFi bridge
Amplificatore Wi-Fi Bluetooth
Connessione wifi bluetooth

REF.
7015C002
BXL PACK 1



Blue Fit 50: adaptador tubería 50mm.
Blue Fit 50: 50mm tapping saddle.
Blue Fit 50: Adaptateur de tuyau 50mm.
Blue Fit 50: Adattatore per tubo da 50 mm

REF. 71666
BXL PACK 1



Kit de calibrado.
Blue calibration kit.
Kit de calibration.
Kit di calibrazione.



Blue Check
BXL PACK 144



REF. 71664
(EN/FR/DE/NL)

Tiras de prueba para analizar la calidad del agua de la piscina
After test to analyse water quality of the pool



REF. 71665
(EN/ES/IT/PT)

Bandelettes d'analyse pour analyser la qualité de l'eau de la piscine.
Strisce di prova per analizzare l'acqua della piscina

■ complementos ■ complements

ELECTROLISIS DE SAL SALT CHLORINATOR ELECTROLYSE AU SEL Elettrolisi SALINA

Los cloradores por electrolisis de sal generan cloro para la desinfección de la piscina a partir de sal. La electrolisis de sal tiene varias ventajas: genera y dosifica automáticamente el cloro en la piscina, evita el almacenamiento y la manipulación de producto químico y es totalmente seguro, ya que sólo utiliza sal común.

L'électrolyse au sel présente plusieurs avantages. Elle génère et dose automatiquement le niveau de chlore dans la piscine, évite le stockage et la manipulation de produits chimiques et est totalement sûre pour la santé, étant donné que le sel utilisé est du sel naturel et commun à tout le monde.

Through electrolysis of salt, the chlorinators generate chlorine and salt to disinfect the swimming pool. The electrolysis of salt has various advantages: Generating and automatically dosing the chlorine in the swimming pool, avoids the handling and storage of chemical products and it completely safe, using only sodium chloride.

I clorinatori per elettrolisi salina producono cloro per la disinfezione della piscina partendo dal sale. L'elettrolisi salina ha diversi vantaggi: produce e provvede al dosaggio automatico del cloro nella piscina, evita l'immagazzinamento e l'uso di prodotti chimici ed è del tutto sicura in quanto fa uso del sale comune.

GRE SALT SYSTEM "ALL IN ONE"

REF. SCGPH100 BXL PACK 1



Hasta 100m³
Producción de cloro: 21 g/h
Electrolisis de sal + Controlador de pH + Bomba dosificadora

Jusqu'à 100m³
Production de chlore: 21 g/h
Electrolyse au sel + Contrôleur de pH + Pompe doseuse

Until 100m³
Chlorine production: 21 g/h
Salt chlorinator + pH control + Dosing pump

Fino a 100m³
Produzione di cloro: 21 g/h
Elettrolisi salina + Regolatore di pH + Pompa per il dosaggio del prodotto chimico



REF. SCGPH60 BXL PACK 1



Hasta 60m³
Producción de cloro: 12 g/h
Electrolisis de sal + Controlador de pH + Bomba dosificadora

Jusqu'à 60m³
Production de chlore: 12 g/h
Electrolyse au sel + Contrôleur de pH + Pompe doseuse

Until 60m³
Chlorine production: 12 g/h
Salt chlorinator + pH control + Dosing pump

Fino a 60m³
Produzione di cloro: 12 g/h
Elettrolisi salina + Regolatore di pH + Pompa per il dosaggio del prodotto chimico

GRE SALT SYSTEM

REF. SCG100 BXL PACK 1



Hasta 90m³
Producción de cloro: 21 g/h
Jusqu'à 90m³
Production de chlore: 21 g/h

Until 90m³
Chlorine production: 21 g/h
Fino a 90m³
Produzione di cloro: 21 g/h

REF. SCG60 BXL PACK 1



Hasta 60m³
Producción de cloro: 12 g/h
Jusqu'à 60m³
Production de chlore: 12 g/h

Until 60m³
Chlorine production: 12 g/h
Fino a 60m³
Produzione di cloro: 12 g/h



GRE BALANCE

REF. EESB55 CBX PACK 1



Hasta 55m³
Producción de cloro: 8 g/h
Fácil instalación, sin mantenimiento

Jusqu'à 55m³
Production de chlore: 8g/h
Facile à installer, sans maintenance

Until 55m³
Chlorine production: 8 g/h
Easy installation, maintenance free

Fino a 55m³
Produzione di cloro: 8 g/h
Semplice da installare, non necessita di manutenzione



SAL ESPECIAL PARA PISCINA POOL SALT
SEL SPÉCIAL PISCINE SALE PER PISCINE



REF. 90365

PB PACK 1
 PALET 40U.



Sal compacta
 saco 25kg
 Sel compacté
 sac 25kg

Compact salt
 bag 25kg
 Sale compatto
 25kg



REF. AR2000

BXL PACK 1



Kit Bypass
 Contiene: 3 Válvulas apertura/cierre + 2 mangueras Ø38 mm x 1,5 m + 6 piezas de reducción Ø38 - 50 mm para encolar + 4 abrazaderas

Bypass kit
 Contains: 3 opening/closing valves + 2 hoses Ø38 mm x 1,5 m + 6 reduction parts Ø38 - 50 mm to glue + 4 lamps

Kit Bypass
 Comprend: 3 vannes ouverture / fermeture + 2 tuyaux Ø38 cm x 1,5 m + 6 pièces réduction Ø38 - 50 mm à coller + 4 colliers

Kit Bypass
 Contiene: 3 valvole di apertura/chiusura + 2 tubi flessibili Ø38 cm x 1,5 m + 6 pezzi adattatori Ø38 - 50 mm da incollare + 4 fascette

BOMBA DOSIFICADORA Y CONTROLADOR POOL DOSING SYSTEMS
CONTRÔLEUR DE PH ET POMPE DOSEUSE REGULATORE E DOSATORE



REF. CPH14

BXL PACK 1



El controlador de pH con bomba peristáltica para piscina enterrada automatiza la regulación del pH, lo que permite estabilizar el pH en el valor ideal para su confort y optimizar la eficacia del tratamiento de desinfección.

pH-Control dosing system is a peristaltic pump designed to maintain a chosen pH level on inground pools, allowing stabilize the pH in the ideal value for comfort and to optimize the efficiency of the disinfection treatment.

Le contrôleur de pH avec pompe péristaltique pour piscine enterrée automatise la régulation du pH, ce qui permet de stabiliser le pH sur la valeur idéale pour votre confort et optimiser l'efficacité du traitement de désinfection.

Il regolatore di pH con pompa peristaltica per piscine interrate automatizza la regolazione del pH consentendo di stabilizzarlo su un valore ideale e ottimizzando l'efficacia del trattamento di disinfezione.



REF. BDP4

BXL PACK 1



Bomba dosificadora peristáltica. Caudal variable 4 l/h y 1,5 Bar. Permite dosificar el producto químico de forma fácil y segura.

Peristaltic dosing pump. Variable flow rate. 4 l/h and 1,5 Bar. Safe and easy way of dosing of the chemical product UV-C.

Pompe doseuse péristaltique. Vitesse variable 4l/h et 1,5 bar. Permet le dosage de produit chimique de façon facile et précise.

Pompa per il dosaggio del prodotto chimico. Pressione variabile 4 l/h e 1,5 Bar

ILUMINACIÓN PARA PISCINAS ENTERRADAS IN GROUND POOLS LIGHTING
ÉCLAIRAGE POUR PISCINES ENTERRÉES ILLUMINAZIONE PER PISCINE INTERRATE



REF. LEDP56WE

CBX PACK 1



8 412081 304939

Lámpara LED BLANCA PAR56. Muy fácil instalación 100% fabricada en EU (fábrica propia). Los LED e ofrecen una vida útil de 25000h.
 Ampoule LED BLANCHE PAR56. Très facile à installer 100% fabriquée en Europe (usine propre). Les ampoules offrent une durée de vie de 25 000 h.

PAR56 WHITE LED lamp. Easily installed lamp. 100% manufactured in EU (own production). LED has a useful life of 25,000 h.
 Lampada PAR56 LED BIANCA. Lampada di semplicissima installazione, prodotta al 100% in EU (produzione propria). Offre una durata utile di 25.000 ore.



REF. LEDP56CE

CBX PACK 1



8 412081 304946

Lámpara LED COLOR PAR56. Muy fácil instalación 100% fabricada en EU (fábrica propia). Los LED e ofrecen una vida útil de 25000h.
 Ampoule LED COULEUR PAR56. Très facile à installer 100% fabriquée en Europe (usine propre). Les ampoules offrent une durée de vie de 25 000 h.

PAR56 COLOUR LED lamp. Easily installed lamp. 100% manufactured in EU (own production). LED has a useful life of 25,000 h.
 Lampada LED COLOR PAR56. Lampada di semplicissima installazione, prodotta al 100% in EU (produzione propria). Offre una durata utile di 25.000 ore.



REF. 40710

BX PACK 6



8 427370 407109

Bombilla proyector. 300w para
 Ampoule projecteur. 300w pour

300w para
 300w pour

300w bulb for underwater light.
 Lampada 300w per faro.

PISCINAS ENTERRADAS Y PISCINAS MADERA IN GROUND AND WODDEN POOLS
ECLAIRAGE POUR PISCINES ENTERRÉES ET BOIS PER PISCINE INTERRATE ED IN LEGNO

REF. PLREB BXL PACK 1



Proyector LED BLANCO
para piscina enterrada y
de madera
Projecteur LED BLANCHE
pour piscine enterrée et
bois

WHITE LED projector
for in-ground and
wodden pools
Faretto LED BIANCO
per piscina interrata e
in legno

REF. PLREC BXL PACK 1



Proyector LED COLOR
para piscina enterrada y
madera.
Con control remoto
Projecteur LED de
COULEUR pour piscine
enterrée et bois.
Avec télécommande.

COLOR LED projector for
in-ground and wooden
pools.
With remote control.
Faretto LED MULTICOLOR
per piscina interrata e in
legno.
Include telecomando.



ILUMINACIÓN PARA PISCINAS SOBRE SUELO ABOVE GROUND POOLS
LIGHTING ÉCLAIRAGE POUR PISCINES HORS SOL ILLUMINAZIONE PER
PISCINE FUORI TERRA

REF. PLWPB

CBX PACK 4



Proyector led blanco **para piscinas de madera y composite**

Led de bajo consumo. Potencia 16w. Fácil instalación. Ofrecen una vida útil entre 50.000 y 100.000 horas. Gran calidad: Fabricado en Europa. Incluye 5m de cable + transformador.

Projecteur led blanc **pour piscines en bois et composite.** Led à basse consommation. Puissance 16w. Facile à installer. Durée de vie : de 50 000 à 100 000 heures. Grande qualité: fabriqué en Europe. Comprend: 5m câble + transformateur.

White LED projector **for wooden and composite pools.** Low consumption LED. Power: 16 W. Easy installation, since a standard plug is included Long life: 50.000 to 100.000 hours. High quality: Made in Europe. 5m wire + transformer included.

Proiettore a led di colore bianco **per piscine in legno e in materiale composito.** Led a basso consumo Potenza 16w. Semplice da installare. Offrono una vita utile compresa tra 50.000 e 100.000 ore. Qualità elevata: Prodotto in Europa. 5m cavo + transformador.



REF. LEDRW

CBX PACK 12



Proyector LED BLANCO de alto rendimiento para conectar a la válvula de retorno. Adaptable a piscinas elevadas tanto autoportantes como de pared rígida. Caudal mínimo necesario: 3.000 l/h. Funciona sin necesidad de batería.

Projecteur LED BLANCHE à haut rendement pour connecter à la buse de refoulement. Adaptable à des piscines hors-sol, aussi bien autoportantes qu'avec des parois rigides. Débit minimum nécessaire: 3 000 l/h. Fonctionne sans nécessité de batterie.

WHITE LED projector for connecting to the return valve. Adaptable for movable above ground pools with rigid walls. High performance WHITE LEDs. Generates light at no cost, does not need batteries. Minimal flow needed: 3000 l/h

Proiettore LED BIANCO a resa elevata per connessione alla valvola di ritorno. Si adatta a piscine fuori terra, sia autoportanti che a parete rigida. Flusso minimo necessario: 3.000 l/h. Funziona senza batteria.



REF. LEDRC

CBX PACK 12



Proyector LED COLOR de alto rendimiento para conectar a la válvula de retorno. Adaptable a piscinas elevadas tanto autoportantes como de pared rígida. Caudal mínimo necesario: 3.000 l/h. Funciona sin necesidad de batería.

Projecteur LED COULEUR à haut rendement pour connecter à la buse de refoulement. Adaptable à des piscines hors-sol, aussi bien autoportantes qu'avec des parois rigides. Débit minimum nécessaire: 3 000 l/h. Fonctionne sans nécessité de batterie.

COLOUR LED projector for connecting to the return valve. Adaptable for movable above ground pools with rigid walls. High performance COLOUR LEDs. Generates light at no cost, does not need batteries. Minimal flow needed: 3000 l/h

Proiettore LED COLOR a resa elevata per connessione alla valvola di ritorno. Si adatta a piscine fuori terra, sia autoportanti che a parete rigida. Flusso minimo necessario: 3.000 l/h. Funziona senza batteria.





REF. PLEDIC

BL PACK 6



Projector LED COLOR para piscina elevada de acero. Fácil instalación, se pega a la chapa mediante un imán. Incorpora mando a distancia para fácil manejo. Tecnología Led de bajo consumo.

Projecteur LED de COULEUR pour piscine hors sol. Ils sont spécialement conseillés pour les piscines hors sol en tôle. Se fixe simplement sur la tôle grâce à un aimant. Ils sont livrés avec une télécommande très simple à utiliser. Technologie LED à faible consommation.

COLOR LED projector for above ground pools. Stick to the sheet with a magnet and ready to use. Includes remote control for easy operation. Energy-saving LED technology.

Faretto LED MULTICOLOR per piscina fuoriterra. Foglio adesivo con un magnete pronto all'uso. Include telecomando a distanza per un facile funzionamento. Risparmio energetico tecnologia al LED.



REF. PLED2

CS PACK 4



Conjunto de 2 proyectores LED BLANCOS para piscina elevada de acero. Fácil instalación, se pega a la chapa mediante un imán. Incorpora mando a distancia para fácil manejo. Tecnología Led de bajo consumo.

Ensemble de 2 projecteurs LED pour piscine hors sol. Ils est spécialement conseillé pour les piscines hors sol en tôle. Se fixe simplement sur la tôle grâce à un aimant. Ils sont livrés avec une télécommande très simple à utiliser. Technologie LED à faible consommation.

Set of 2 WHITE LED projectors for above ground pools. Stick to the sheet with a magnet and ready to use. Includes remote control for easy operation. Energy-saving LED technology.

2 Faretti LED per piscina fuoriterra. Foglio adesivo con un magnete pronto all'uso. Include telecomando a distanza per un facile funzionamento. Risparmio energetico tecnologia al LED.

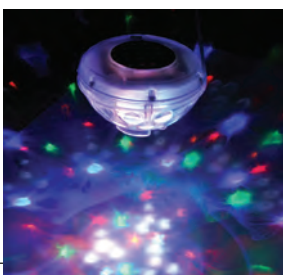

REF. 90173

CBX PACK 6



Lámpara fantasía
7 programas de luz diferentes.

Lampe fantasie
sept jeux de lumière sur les parois et le fond de la piscine.

Fancy lamp
7 different lighting programmes.

Lampada fantasia
ette giochi di luce differenti ai lati della piscina e sul fondo.



**CALEFACCIÓN HEATING SYSTEMS
CHAUFFAGE RISCALDAMENTO**

La bomba de calor es el método más eficiente para calentar una piscina y además permite alargar la temporada de baño.

Las bombas de calor mueven la energía térmica en la dirección opuesta a la transferencia de calor espontánea, al absorber el calor de un espacio frío y liberarlo a uno más cálido.

La pompe à chaleur est la méthode la plus efficace pour chauffer une piscine et permet également d'allonger la saison des baignades.

Les pompes à chaleur déplacent l'énergie thermique dans le sens opposé au transfert de chaleur spontanée, en absorbant la chaleur d'un espace froid et en la libérant dans un espace plus chaud.

The heat pump is the most efficient method for heating a pool and in addition allows extending the bathing season

Heat pumps move thermal energy in the opposite direction to spontaneous heat transfer, by absorbing heat from a cold space and releasing it into a hotter one.

La pompa di calore rappresenta il metodo più efficace per riscaldare la piscina e consente di utilizzarla tutto l'anno.

Le pompe di calore muovono l'energia termica in direzione opposta rispetto al trasferimento spontaneo di calore, assorbendo calore da uno spazio freddo e rilasciandolo in uno più caldo.

**BOMBAS DE CALOR MINI PARA PISCINAS SOBRE SUELO
ABOVE GROUND POOLS MINI HEAT PUMPS
POMPES À CHALEUR MINI POUR PISCINES HORS SOL
POMPA DI CALORE MINI PER PISCINE FUORI TERRA**

**mini
pool
heating**



MINI HEAT PUMPS

BXL PACK 1

Bomba de calor Mini para pequeño volumen de agua. No necesitan bypass. Conexiones 32 y 38 mm.

Mini heat pumps for reduced water volumes. Bypass not necessary. 32 and 38 mm connections.

Pompes à chaleur Mini pour petit volume d'eau. Elle n'a pas besoin de bypass. Embouts soudés 32 et 38 mm.

Pompa di calore Mini per piscine a ridotto volume di acqua. Non ha bisogno di un bypass. Raccordi 32 e 38 mm.

	HPM20	HPM30	HPM40
Aire · Air · Aria 28°C / Agua · Water · Eau · Acqua 28°C / Humedad · Humidity · Humidité · Umidità 80%			
Salida de calor · Heat output · Sortie de chaleur · Produzione di calore	2,5 kW	4,2 kW	5,5 kW
Consumo energético · Power Consumption · Consommation énergétique · Consumo di energia	0,59 kW	1,00 kW	1,31 kW
Volumen máximo de la piscina · Max Pool volume · Volume maximum de la piscine · Volume massimo della piscina	20 m ³	30 m ³	40 m ³
Aire · Air · Aria 15°C / Agua · Water · Eau · Acqua 26°C / Humedad · Humidity · Humidité · Umidità 70%			
Salida de calor · Heat Output · Sortie de chaleur · Produzione di calore	1,9 kW	3,2 kW	4,2 kW
Consumo energético · Power Consumption · Consommation énergétique · Consumo di energia	0,56 kW	0,91 kW	1,2 kW

REF. HPM20



REF. HPM30



REF. HPM40



BOMBAS DE CALOR GRE PARA PISCINAS SOBRE SUELO Y ENTERRADAS
GRE HEAT PUMPS FOR ABOVE AND INGROUND POOLS
POMPES À CHALEUR GRE POUR PISCINES HORS SOL ET ENTERRÉES
POMPA DI CALORE GRE PER PISCINE FUORI TERRA E INTERRATA

**easy
pool
heating**



SINGLE SPEED HEAT PUMPS

BXL PACK 1

Temperatura operativa: desde 7 °C. «Conexión rápida» incluida. Sistema de descongelación automático. Cubierta de invierno incluida. Para piscinas de hasta 70 m³. Intercambiador de calor de titanio.

Working temperature: from 7°C. "Quick connection" included. Automatic defrosting system. Winter cover included. For pools up to 70 m³. Titanium heat exchanger.

Température de fonctionnement : à partir de 7 °C. "Connexion rapide" incluse. Système de dégivrage automatique. Bâche d'hiver incluse. Pour piscines jusqu'à 70 m³. Échangeur de chaleur en titane.

Temperatura di esercizio: da 7°C. "Connessione rapida" inclusa. Sistema di sbrinatorio automatico. Copertura invernale inclusa. Per piscine fino a 70 m³. Scambiatore di calore in titanio.

	HPG25	HPG40	HPG50	HPG70
Aire · Air · Aria 28°C / Agua · Water · Eau · Acqua 28°C / Humedad · Humidity · Humidité · Umidità 80%				
Salida de calor · Heat output · Sortie de chaleur · Produzione di calore	5 kW	7 kW	11 kW	13 kW
Consumo energético · Power Consumption · Consommation énergétique · Consumo di energia	1 kW	1,40 kW	2,20 kW	2,60 kW
Volumen máximo de la piscina · Max Pool volume · Volume maximum de la piscine · Volume massimo della piscina	25 m ³	40 m ³	50 m ³	70 m ³
Aire · Air · Aria 15°C / Agua · Water · Eau · Acqua 26°C / Humedad · Humidity · Humidité · Umidità 70%				
Salida de calor · Heat Output · Sortie de chaleur · Produzione di calore	3,5 kW	5 kW	7 kW	9 kW
Consumo energético · Power Consumption · Consommation énergétique · Consumo di energia	0,88 kW	1,25 kW	1,75 kW	2,25 kW

REF. HPG25



8 412081 313122

REF. HPG40



8 412081 313139

REF. HPG50



8 412081 313146

REF. HPG70



8 412081 313153

■ complementos ■ complements

BOMBAS DE CALOR GRE PARA PISCINAS SOBRE SUELO Y ENTERRADAS GRE HEAT PUMPS FOR ABOVE AND INGROUND POOLS POMPES À CHALEUR GRE POUR PISCINES HORS SOL ET ENTERRÉES POMPA DI CALORE GRE PER PISCINE FUORI TERRA E INTERRATA

inverter pool heating



INVERTER- VARIABLE HEAT PUMPS

BXL PACK 1

"Bombas de calor con inversor (velocidad variable). Temperatura operativa: desde 7 °C. Dos velocidades para ahorrar energía. Descongelación automática. Cubierta de invierno incluida. Para piscinas de hasta 85 m³. Intercambiador de calor de titanio.

Inverter (Variable speed) heat pumps. Working temperature: from 7°C. 2 speeds for energy saving. Automatic defrosting. Winter cover included. For pools up to 85 m³. Titanium heat exchanger.

Pompes à chaleur avec inverseur (vitesse variable). Température de fonctionnement : à partir de 7 °C. Deux vitesses pour économiser de l'énergie. Dégivrage automatique. Bâche d'hiver incluse Pour piscines jusqu'à 85 m³ Échangeur de chaleur en titane"

"Pompe di calore inverter (velocità variabile). Temperatura di esercizio: da 7°C. 2 velocità per il risparmio energetico. Sbrinatorio automatico. Copertura invernale inclusa. Per piscine fino a 85 m³. Scambiatore di calore in titanio.

	HPGI50	HPGI60	HPGI70	HPGI85
Aire · Air · Aria 28°C / Agua · Water · Eau · Acqua 28°C / Humedad · Humidity · Humidité · Umidità 80%				
Salida de calor · Heat output · Sortie de chaleur · Produzione di calore	9-3,5 kW	11-4,8 kW	14-5 kW	16-5,3 kW
Consumo energético · Power Consumption · Consommation énergétique · Consumo di energia	1,61-0,43 kW	1,96-0,6 kW	2,5-0,63 kW	2,85-0,66 kW
Volumen máximo de la piscina · Max Pool volume · Volume maximum de la piscine · Volume massimo della piscina	50 m ³	60 m ³	70 m ³	85 m ³
Aire · Air · Aria 15°C / Agua · Water · Eau · Acqua 26°C / Humedad · Humidity · Humidité · Umidità 70%				
Salida de calor · Heat Output · Sortie de chaleur · Produzione di calore	6,6-2,5 kW	7,9-3,5 kW	9,2-3,6 kW	11,2-3,8 kW
Consumo energético · Power Consumption · Consommation énergétique · Consumo di energia	1,65-0,43 kW	1,98-0,6 kW	2,38-0,62 kW	2,8-0,66 kW

REF. HPGI50



8 412081 313160

REF. HPGI60



8 412081 313177

REF. HPGI70



8 412081 313184

REF. HPGI85



8 412081 313191

CALEFACCIÓN SOLAR SOLAR HEATING SYSTEM
CHAUFFAGE SOLAIRE RISCALDAMENTO SOLARE



Sistemas para calentamiento del agua de la piscina mediante la acción solar. Solar pool water heating systems. Chauffage solaire pour piscine. Fabriqué en polyéthylène. Sistema per il riscaldamento dell'acqua della piscina per mezzo dell'azione del sole.



REF. AR2069 CBX PACK 1  8 412081 203331

Fabricado en polietileno. Aumenta la Temperatura del agua hasta 6°C. Mas de 12 kw/h de calor al dia. 600x60 cm. Peso 7 kg. Potencia de la bomba mínima recomendada: 1/3 CV.

Made of polythene. Water temperature can be increased up to 6 °C. 600x60 cm. Wight: 7 kg. Minimum recommended pump output: 1/3 hp.

Il augmente la température de l'eau jusqu'à 6°C. Dimensions du produit : 600x60 cm. Poids 7 kg. Puissance de la pompe minimale recommandée: 1/3 CV.

Inpolietilene. Aumenta la temperatura dell'acqua fino a 6°C. 600x60 cm. Peso 7 kg. Potenza minima della pompa raccomandata: 1/3 CV.

REF. 90230 CBX PACK 1  8 427370 902307

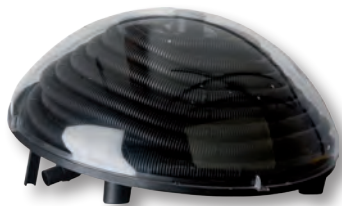

Permite aumentar la temperatura de su piscina por la acción del sol. Los calentadores pueden conectarse entre sí en serie. Aumenta la temperatura del agua 3°C en piscinas entre 7,5m³ y 10m³.

Solar pool water heating system. The heaters should be connected in series to heat the pool. Each solar heater increases the temperature of the swimming pool by 3°C due to solar action.

Système pour le chauffage solaire de l'eau de la piscine. Les réchauffeurs peuvent se connecter entre eux en série. Augmente la température de 3°C max. pour les piscines entre 7,5m³ et 10m³.

Permette di aumentare la temperatura della sua piscina tramite l'azione dei raggi solari. Ogni riscaldatore solare permette di aumentare la temperatura della piscina no a 3°C tramite l'azione naturale del sole.

■ complementos ■ complements

DUCHAS SHOWERS DOUCHES DOCCIA



Solar Solar Solaire Solare		●	●	●	●	●	●	●	●	●
Litros Liters Litres Litri		32 l	32 l	40 l	38 l	35 l	35 l	32 l	30 l	
Aluminio Aluminium Aluminium Alluminio		●	●		●			●	●	
Acero inoxidable Stainless steel Acier inoxydable Acciaio inossidabile	●	●								
PVC				●		●	●			
Polietileno Polyethylene Polyéthylène Polietilene										
Grifo lavapies footwash tap Rubinet lave pieds Rubinetto lavapiedi	●		●	●	●	●	●	●	●	
2 piezas 2 pieces 2 pièces 2 pezzi								●		



Solar Solar Solaire Solare	●	●	●	●	●	●	●	●	●	
Litros Liters Litres Litri	30 l	25 l	25 l	20 l	20 l	20 l	18 l	9 l	9 l	
Aluminio Aluminium Aluminium Alluminio							●			●
Acero inoxidable Stainless steel Acier inoxydable Acciaio inossidabile										
PVC	●		●	●	●	●		●	●	
Polietileno Polyethylene Polyéthylène Polietilene		●								
Grifo lavapies footwash tap Rubinet lave pieds Rubinetto lavapiedi		●								
2 piezas 2 pieces 2 pièces 2 pezzi					●		●	●	●	

DUCHAS MINIMAL MINIMAL SHOWERS
DOUCHES AU STYLE MINIMALISTE DOCCIA MINIMAL

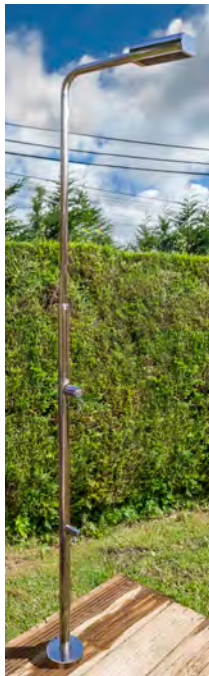

REF. DAI43F
 BXL PACK 1



Ducha de acero inoxidable.
 Tubo Ø43 mm.
 Rociador antical.
 *Incluye lavapiés.

Stainless steel shower.
 43 mm diameter tube.
 Lime-free overhead sprayer.
 *Includes foot tap.

Douche en acier inoxydable.
 Tube Ø43 mm.
 Pommeau anti-calcaire.
 *Inclut un rince-pieds.

Doccia in acciaio inossidabile.
 Tubo Ø43 mm.
 Doccino anticalcare.
 *Include lavapiedi.

REF. DAI43
 BXL PACK 1



Ducha de acero inoxidable.
 Tubo Ø43 mm.
 Rociador antical.

Stainless steel shower.
 43 mm diameter tube.
 Lime-free overhead sprayer.

Douche en acier inoxydable.
 Tube Ø43 mm.
 Pommeau anti-calcaire.

Doccia in acciaio inossidabile.
 Tubo Ø43 mm.
 Doccino anticalcare.

Anclaje y conexión a la toma de agua a través del suelo. Assembly and water connection intake through the ground. Fixation et branchement à l'arrivée d'eau par le sol. Fissaggio e collegamento alla presa d'acqua attraverso il terreno.

DUCHAS SOLARES SOLAR SHOWERS
DOUCHES SOLAIRES DOCCE SOLARI



REF. DSALR32W
 BXL PACK 1



Ducha solar redonda 32l
 Aluminio aspecto madera
 Con grifo lavapiés

Round solar shower 32l
 Aluminium Woodlike
 With footwash tap

Douche solaire ronde 32l
 Aluminium Aspect bois
 Avec robinet lave pieds

Doccia solare round 32l
 Alluminio Imitazione legno
 Rubinetto lavapiedi



REF. DSALC32W
 BXL PACK 1



Ducha solar cuadrada 32l
 Aluminio Aspecto madera
 Con grifo lavapiés

Square solar shower 32l
 Aluminium Woodlike
 With footwash tap

Douche solaire carrée 32l
 Aluminium Aspect bois
 Avec robinet lave pieds

Doccia solare square 32l
 Alluminio Imitazione legno
 Rubinetto lavapiedi

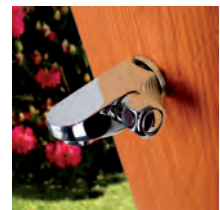
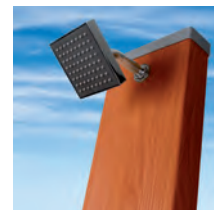

■ complementos ■ complements



Ref. SSP40
BXL PACK 1



8 412081 307091

Ducha solar 40l
PVC-Con grifo lavapies
Solar shower 40l
PVC. With footwash tap
Douche solaire 40l
PVC. Avec robinet lave pieds
Doccia solare 40l
PVC. Rubinetto lavapiedi







Ref. DSALP38
BXL PACK 1



8 412081 312811

Ducha solar 38l
Aluminio-Con grifo lavapies
Solar shower 38l
Aluminium. With footwash tap
Douche solaire 38l
Aluminium. Avec robinet lave pieds
Doccia solare 38l
Alluminio. Rubinetto lavapiedi





Ref. DSPS35
BXL PACK 1



8 412081 272603

Ducha solar 35l
PVC-Con grifo lavapies
Solar shower 35l
PVC. With footwash tap
Douche solaire 35l
PVC. Avec robinet lave pieds
Doccia solare 35l
PVC. Rubinetto lavapiedi



Ref. AR1035P
BXL PACK 1



8 412081 307114

Ducha solar 35l
PVC-Con grifo lavapies
2 piezas
Solar shower 35l
PVC. With footwash tap
2 pieces
Douche solaire 35l
PVC. Avec robinet lave pieds
2 pièces
Doccia solare 35l
PVC. Rubinetto lavapiedi
2 pezzi



REF. ARI130
BXL PACK 1

8 412081 224510

Ducha solar de jardín 32l
Aluminio
Con nebulizador y grifo lavapies

Round solar shower 32l
Aluminium
With footwash tap

Douche solaire 32 litres avec
brumisateur et lave-pieds
Aluminium

Doccia solare 32l
Alluminio
Nebulizzatore e rubinetto lavapiedi



REF. DSA30
BXL PACK 1

8 412081 303222

Ducha solar 30l
Aluminio
Solar shower 30l
Aluminium
Douche solaire 30l
Aluminium
Doccia solare 30l
Alluminio



REF. ARI030
BXL PACK 1

8 412081 220765

Ducha solar 30l
PVC
Garden solar shower 30l
PVC
Douche solaire de jardin 30l
PVC
Doccia solare 30l
PVC



Ref. SSR25
BXL PACK 1

8 412081 307107

Ducha solar 25l
Polietileno-Con grifo lavapies
Solar shower 25l
Polyethylene. With footwash tap
Douche solaire 25l
Polyéthylène. Avec robinet lave pieds
Doccia solare 25l
Polietilene. Rubinetto lavapiedi

■ complementos ■ complements



REF. AR10250

BXL PACK 1



8 412081 224497

Ducha solar 25l
PVC
Garden solar shower 25l
PVC
Douche solaire de jardin 25l
PVC
Doccia solare 25l
PVC



REF. AR1020W

BXL PACK 1



8 412081 264387

Ducha solar 20l
PVC aspecto madera
Solar shower 20l
Woodlike PVC
Douche solaire 20l
PVC Aspect bois
Doccia solare 20l
PVC Imitazione legno



REF. AR1020P

BXL PACK 1



8 412081 240817

Ducha solar 20l
PVC
2 piezas
Garden solar shower 20l
PVC
2 pieces
Douche solaire de jardin 20l
PVC
2 pièces
Doccia solare 20l
PVC
2 pezzi



REF. 40664A

BXL PACK 1



8 427370 406645

Ducha solar 20l
PVC
Garden solar shower 20l
PVC
Douche solaire de
jardin 20l - PVC
Doccia solare 20l
PVC



Ref. SSAL18

BXL PACK 1



Ducha solar 18 l
Aluminio - 2 piezas
Solar shower 18l
Aluminium - 2 pieces
Douche solaire 18l
Aluminium - 2 pièces
Doccia solare 18l
Alluminio - 2 pezzi



NEW
2021

REF. AR1009W

BXL PACK 1



Ducha solar 9l
PVC aspecto madera
2 piezas
Garden solar shower 9l
Woodlike PVC
2 pieces
Douche solaire de jardin 9l
PVC Aspect bois
2 pièces
Doccia solare 9l
PVC Imitazione legno
2 pezzi



REF. AR1009

BXL PACK 1



Ducha solar 9l
PVC
2 piezas
Garden solar shower 9l
PVC
2 pieces
Douche solaire de jardin 9l
PVC
2 pièces
Doccia solare 9l
PVC
2 pezzi



REF. AR104

CBX PACK 6



Ducha aluminio. Fácil
instalación y conexión
Aluminium shower.
Easy installation and connection
Douche en aluminium.
Montage et raccordement facile
Doccia alluminio.
Facilità di installazione e collegamento



REF. LP01

PB PACK 6



Lavapiés Footwash Pédiluve Lavapiedi

■ complementos ■ complements

RACORDERÍA PVC FITTINGS RACCORDS EN PVC RACCORDERIA IN PVC



REF. 40537 
BX PACK 15 8 427370 405372

Enlace Ø 50 HXH PN16
PVC screw Ø 50 mm PN16
Raccord PVC Ø 50 HXH PN16
Raccordo Ø 50 HXH PN16



REF. 40538 
BX PACK 20 8 427370 405389

Enlace 3P. Ø 50 macho 1" 1/2
PN16
PVC 3 piece union solvent
socket Ø50mm1"1/2
Raccord PVC en 3 parties Ø50
macho 1" 1/2 PN16
Raccordo 3P. Ø 50 maschio
1" 1/2 PN16



REF. 40539 
BX PACK 15 8 427370 405396

Raccordo 3P. Ø 50 macho 2"
PN16
PVC 3 piece union solvent
socket Ø 50mm 2"
Raccord PVC en 3 parties Ø
50 macho 2" PN16
Raccordo 3P. Ø 50 maschio
2" PN16



REF. 40541 
BX PACK 8 8 427370 405419

Válvula antiretorno Ø 50 PN16
Check valve Ø 50 mm
Valve anti-retour Ø 50 PN16
Valvola ritorno Ø 50 PN16



REF. 40543 
BX PACK 6 8 427370 405433

Válvula Ø 50 PN10 PN10
PVC ball valve Ø 50 mm PN10
Valve anti-retour Ø 50 PN10
Valvola Ø 50 PN10 PN10



REF. 40555 
BX PACK 10 8 427370 405556

Racord curva Ø 50 90° PN16
PVC elbow 90° Ø 50 mm PN16
Valve anti-retour 90° Ø 50 PN16
Valvola 90° Ø 50 PN16



REF. 40590 
BX PACK 30 8 427370 405907

Codo Ø 50 90° PN16 - para
encolar
PVC 90° elbow solvent
socket Ø 50 mm
Coude PVC à coller Ø 50
90° PN16
Gomito Ø 50 90° PN16 - da
incollare



REF. 40591 
BX PACK 18 8 427370 405914

Codo Ø 50 45° PN16
PVC 45° elbow solvent socket
Ø 50 mm
Coude PVC Ø 50 45° PN16
Gomito Ø 50 45° PN16



REF. 40592
BX PACK 12 8 427370 405921

Te Ø 50 PN16 - para encolar
PVC-Tee 90° solvent socket
Ø 50 mm
Raccord en T à coller Ø 50 PN16
Raccordo a T Ø 50 PN16 - da
incollare



REF. 40593
BX PACK 18 8 427370 405938

Racord Ø 50 PN16 - para
encolar
PVC union solvent socket Ø
50 mm
Raccord PVC à coller Ø
50 PN16
Raccordo Ø 50 PN16 - da
incollare



REF. 40646
BX PACK 8 8 427370 406461

Válvula Ø50 PN10, manguito
rosca macho
Ball valve Ø50 mm
Vanne Ø50 PN10
embout mâle
Valvola Ø50 PN10, tubo
filettato maschio



REF. 40553
BX PACK 12 8 427370 405532

Adhesivo para PVC 250 g
Blue Adhesive for flexible PVC
pipes 250 g
Colle PVC 250gr
Adesivo per PVC 250 g



REF. 787104 PB PACK 1



Manguera semirígida
reforzada, transparente,
Ø38mm. 25m
Tuyau semi-rigide renforcé,
Transparent, Ø38mm. 25m

Semi-rigid reinforced hose,
transparent, Ø38mm. 25m

Tubo semirigido inforzato,
trasparente, Ø38mm. 25m



REF. 40557 PB PACK 1



Tubo PVC semirígido Ø 50,
25m
Couronne PVC semi-rigide
Ø 50, 25m

Semi-rigid PVC hose Ø 50
mm, 25m
Tubo PVC semirigido Ø 50,
25m

cleaning

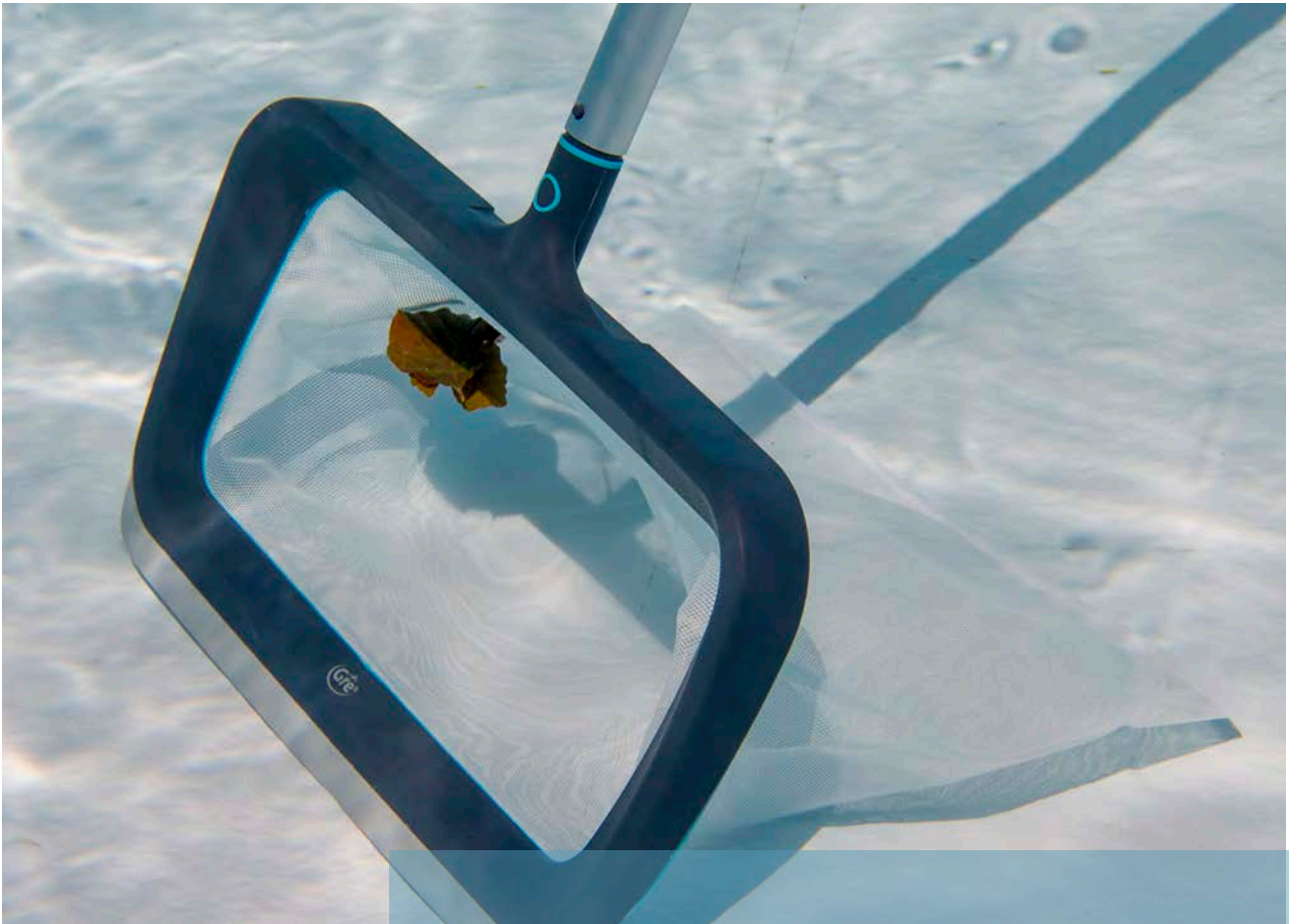

■ Leyenda ■ Legend ■ Légende ■ Legend

BX

caja
box
box
scatola

BXL

caja con etiqueta
box and label
carton avec étiquette
scatola con etichetta

CB

cartoncillo
cardboard wrap
bande carton
cartone

PBH

bolsa de plástico con cartoncillo
polybag with header
sac plastique avec bande carton
sacchetto di plastica con cartone

BL

blister
blister
blister
blister

CS

doble burbuja
clamshell
double coque
doppio rivestimento

CBX

caja litografiada
colour box
boîte de couleur
scatola serigrafata

PB

bolsa de plástico
polybag
sac plastique
busta di plastica

DIS

display
display
display
display



manguera
hose
tuyau
tubo



cable
wire
câble
cavo

material de limpieza cleaning material

MATERIAL DE LIMPIEZA	142	CLEANING MATERIAL
Robots	144	Robots
Limpiafondos eléctricos	145	Electric cleaners
Limpiafondos automáticos	149	Automatic cleaners
Limpiafondos de aspiración	151	Vacuum cleaners
Kits limpiafondos	152	Vacuum cleaners kits
Limpiafondos Ventury	153	Ventury vaccum
Gama Graphite	154	Graphite range
Gama Confort	158	Confort range
Recogehojas	160	Leaf nets and rakes
Limpiafondos manuales	160	Vacuum heads
Cepillos	161	Brushes
Espojas	161	Sponges
Termómetros	162	Thermometers
Dosificadores	164	Dispensers
Mangos telescópicos	165	Telescopic handles
Cardboard range	166	Cardboard range
BOX	168	BOX
Gama ECO	170	ECO range
Protección invierno	173	Winter protection
Mangueras flotantes	174	Vacuum hoses

matériel de nettoyage materiale di pulizia

MATÉRIEL DE NETTOYAGE	142	MATERIALE DI PULIZIA
Robots	144	Robots
Nettoyeurs de fond électriques	145	Pulitore elettrico
Nettoyeurs automatiques	149	Puliscifondi automatici
Nettoyeurs par aspiration	151	Pulitore fondo ad aspirazione
Kit nettoyeurs	152	Kit Pulitore fondo
Aspirateurs de fond ventury	153	Puliscifondi Ventury
Gamme Graphite	154	Gamma Graphite
Gamme Confort	158	Gamma Confort
Époussettes	160	Raccoglitori
Balais manuels	160	Puliscifondo manuale
Brosses	161	Spazzole
Eponges	161	Spugne
Thermomètres	162	Termometri
Doseurs	164	Dosatori
Manches télescopiques	165	Manico telescopico
Cardboard range	166	Cardboard range
BOX	168	BOX
ECO range	170	ECO range
Protection hiver	173	Protezione inverno
Tuyaux flottants	174	Tubi galleggianti

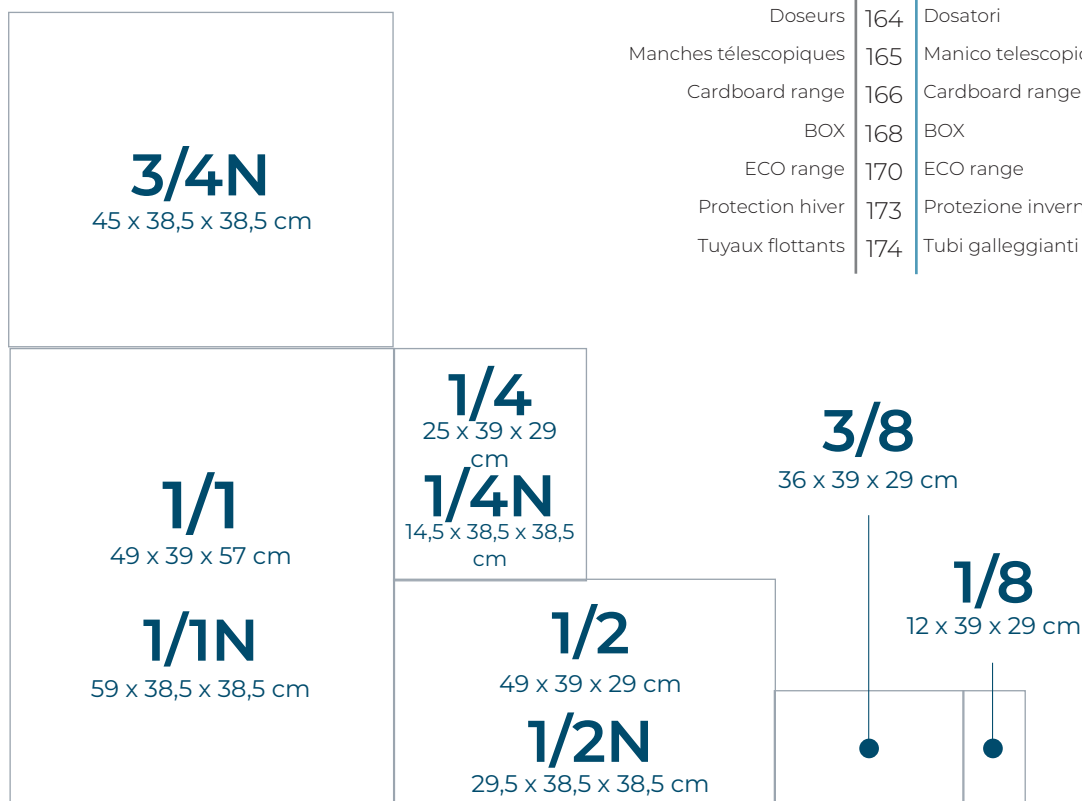

■ material de limpieza ■ cleaning material

ROBOTS LIMPIAFONDOS PISCINAS POOL ROBOTS ROBOTS PISCINE ROBOTS PER PISCINA

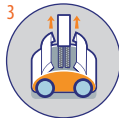

KAYAK CLEVER REF. RKC100J

12 m

CBX PACK 1



El Kayak Clever limpia el fondo inclinado o plano de piscinas hasta 60m² de superficie.

Le robot Kayak Clever RKC100J convient pour tout type de piscine à fond plat ou pente douce d'une superficie jusqu'à 60m².

The Kayak Clever adapts to all types of pools measuring up to 60m² in surface area, cleaning the bottoms whether they are flat or inclined.

Il Robot Kayak Clever RKC100J si adatta a tutti i tipi di piscine fino a 60m² di superficie, pulendo il fondo in piano che inclinato.

1. Plug&Play: Conectar y listo para usar Put the robot in the water and it's ready to clean Prêt à fonctionner Una volta collegato è pronto per lavorare
2. Light: Robot ligero Light robot Robot léger Leggero
3. Top access: Filtro de acceso superior Top access filter Filtre facile à nettoyer avec le système top access Accesso al filtro nella parte superiore del robot

■ matériel de nettoyage ■ materiale di pulizia

LIMPIAFONDOS ELÉCTRICOS ELECTRIC CLEANERS NETTOYEURS DE FOND ÉLECTRIQUES PULITORE ELETTRICO PER FONDO PISCINA

Los limpiafondos eléctricos son una solución cómoda y sencilla para la limpieza de la piscina. Son recargables, sin necesidad de cables y muy manejables debido a su tamaño y forma.

Les nettoyeurs de fond électriques sont une solution pratique et simple pour le nettoyage des piscines. Ils sont rechargeables, sans besoin de câbles et très faciles à utiliser en raison de leur taille et de leur forme.

Electric cleaners are a convenient and simple solution for cleaning the pool. They are rechargeable, wirelessly and very manageable because of its size and shape.

I pulitori elettrici per fondo piscina rappresentano una soluzione comoda e semplice per la pulizia della piscina. Sono ricaricabili, non necessitano di cavi e sono maneggevoli grazie alle loro dimensioni e alla forma.



Potencia Power rating Puissance Potenza	35 W	13-20 W	35 W	25 W	17 W	17 W	10 W
Potencia de succión Suction power Puissance d'aspiration Potenza di aspirazione	150 m ² /h	35-50 l/h	150 m ² /h	130 m ² /h	150 m ² /h	150 m ² /h	15 l/h
Capacidad de filtrado Filter capacity Capacité de filtration Capacità del filtro	1,5 l / 3 l	1,5 l	1,5 l / 3 l	1,5 l	0,8 l	1,5 l	0,65 l
Tiempo de funcionamiento Operating time Temps de fonctionnement Tempo di operatività	90 mins	45 mins	90 mins	60 mins	45 mins	-	-
Tiempo de carga Recharging time Temps de charge Tempo di carica	3 hours	3 hours	5 hours	3 hours	3 hours	-	-
Tipo de batería Battery type Type de batterie Tipo di batteria	Lithium battery	Lithium battery	Lithium battery	Lithium battery	Ni - Mh	8 batteries AA	8 batteries AA
Tipo de piscina Type of pool Type de piscine Tipo di piscina							

■ material de limpieza ■ cleaning material

NEW
2021

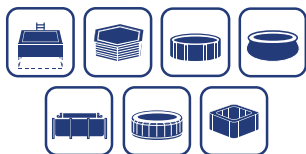

ACTION VAC

REF. VCB50P

CBX PACK 1



8 412081 313061

Limpiafondos multivelocidad con batería para piscinas y spas. Ideal para escalones y zonas de difícil acceso. Inalámbrico y recargable (cargador incluido). Batería de litio: 11,1 V, 4000 mAh. Multivelocidad: 90 l/h – 120 l/h. Potencia: 20-30 W Autonomía: 90 min. Tiempo de carga: 4-5 horas. Capacidad de filtrado: 2,5 litros. Para residuos grandes, utilice primero las bolsas filtrantes, para residuos pequeños, introduzca el cartucho.

Nettoyeur multi-vitesse avec batterie pour piscines et spas. Idéal pour nettoyer les escaliers et les zones à accès difficile. Sans fil, rechargeable (chargeur inclus). Batterie au lithium : 11,1 V, 4000 mAh. Deux vitesses de filtration : 90 l/h – 120 l/h. Puissance : 20-30 W Autonomie : 90 min. Temps de charge : 4-5 heures. Capacité de filtration : 2,5 litres. Pour les gros déchets, utilisez d'abord les sacs filtrants, pour les petits déchets, insérez la cartouche.

Multi speed battery cleaner for pools and spas. Ideal for step and difficult access zones. Cordless, rechargeable (charger included). Lithium battery: 11.1V, 4000 mah. Multi speed: 90l/h – 120l/h. Power: 20-30 W Working time: 90 min. Charging time: 4-5 hours. Filter capacity: 2,5 liters. For big rubbishes, use filter bags first, for fine debris, mount the cartridge into.

"Puliscifondo a batteria multi velocità per piscine e spa. Ideale per gradini e zone di difficile accesso. Cordless, ricaricabile (caricatore incluso). Batteria al litio: 11.1V, 4000 mah. Multi velocità: 90l/h - 120l/h. Potenza: 20-30 W Tempo di esecuzione: 90 min. Tempo di ricarica: 4-5 ore. Capacità filtro: 2,5 litri. Per detriti grossolani, utilizzare prima i sacchetti filtro, per i detriti fini, montare la cartuccia."

SUPER VAC

REF. VCB10P

CBX PACK 2



8 412081 313054

NEW
2021

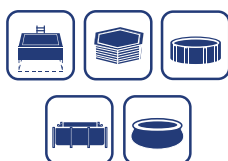

Limpiafondos multivelocidad con batería para piscinas enterradas y elevadas. Ideal para escalones y zonas de difícil acceso. Inalámbrico, recargable (cargador incluido). Batería de litio: 11,1 V, 4000 mAh. Multivelocidad: 35 l/h – 50 l/h. Potencia: 13-20 W Autonomía: 45 min. Tiempo de carga: 2-3 horas. Capacidad de filtrado: 1,5 litros. Para residuos grandes, utilice primero las bolsas filtrantes, para residuos pequeños, introduzca el cartucho.

Nettoyeur multi-vitesse avec batterie pour piscines enterrées et hors sol. Idéal pour nettoyer les escaliers et les zones à accès difficile. Sans fil, rechargeable (chargeur inclus). Batterie au lithium : 11,1 V, 4000 mAh. Deux vitesses de filtration : 35 l/h - 50 l/h. Puissance : 13-20 W Autonomie : 45 min. Temps de charge : 2-3 heures. Capacité de filtration : 1,5 litre. Pour les gros déchets, utilisez d'abord les sacs filtrants, pour les petits déchets, insérez la cartouche.

Multi speed battery cleaner for above and inground pools. Ideal for step and difficult access zones. Cordless, rechargeable (charger included). Lithium battery: 11.1V, 4000 mah. Multi speed: 35l/h – 50l/h. Power: 13-20 W Working time: 45 min. Charging time: 2-3 hours. Filter capacity: 1,5 liters. For big rubbishes, use filter bags first, for fine debris, mount the cartridge into.

"Puliscifondo a batteria multi velocità per piscine fuori terra e interrate. Ideale per gradini e zone di difficile accesso. Cordless, ricaricabile (caricatore incluso). Batteria al litio: 11.1 V, 4000 mah. Multi velocità: 35l/h - 50l/h. Potenza: 13 -20 W Tempo di esecuzione: 45 min. Tempo di ricarica: 2-3 ore. Capacità filtro: 1,5 litri. Per detriti più grossolani, utilizzare prima i sacchetti filtro, per i detriti fini, montare la cartuccia."

■ matériel de nettoyage ■ materiale di pulizia



ELECTRIC VAC PLUS

REF. VCB50

CBX PACK 1



8 412081 272528

Limpiafondos eléctrico autónomo - Potencia: 36 W. Se puede utilizar con su propio mango o conectado a un mango telescópico estándar para facilitar su uso en piscinas más profundas. Recargable, sin cables. Incluye 3 baterías recargables litio (4000mah/11,1V). Potencia de succión: 90 l/h. Tiempo de trabajo: 90 minutos. Ligeró, fácil de manejar.

Autonomous electric cleaner – Power: 36 W. Can be used with its own handle or connected to a standard telescopic handle for ease use in deeper pools. Rechargeable, without cables. It includes 3 rechargeable lithium batteries (4000mah/11.1V). Suction power: 90 l/h. Working time: 90 minutes. Lightweight, easy to handle.

Nettoyeur électrique autonome - Puissance: 36 W. Il peut être utilisé avec sa propre poignée ou attaché à une poignée télescopique standard pour faciliter son utilisation dans des bassins plus profonds. Rechargeable, sans câbles. Comprend 3 batteries rechargeables au lithium (4000mah/11.1V). Puissance d'aspiration: 90 l/h. Temps de travail: 90 minutes. Léger, facile à manipuler.

Pulitore elettrico autonomo - Potenza: 36 W. Si può usare con il manico in dotazione o collegato ad un'asta telescopica per agevolare il suo utilizzo in piscine più profonde. Ricaricabile, senza cavo. Include 3 batterie ricaricabili litio. (4000mah/11.1V). Potenza di assorbimento: 90 l/h. Tempo di lavoro: 90 minuti. Leggero, facile da maneggiare.



ELECTRIC VAC

REF. VCB10

CBX PACK 2



8 412081 263298

Especialmente indicado para piscinas enterradas, limpia las escaleras y esquinas donde el limpiafondos automático no llega. Posee un depósito removible de gran capacidad e incorpora un filtro que retiene partículas de pequeño tamaño. Ligeró y de fácil manejo. Recargable y sin cables: funciona con batería de litio recargable de 11,1 V. Posibilidad de uso con su propio asa o conectándolo a una pértiga.

Epecially indicated for embedded pools, cleans stairs and corners where automatic cleaners do not reach. It has a large capacity removable tank and includes a filter to retain small-size particles. Lightweight and easy to use. Rechargeable and without cables: operates with an 11.1 V lithium battery. Possibilities of use with its own handle or connected to a pole.

Spécialement conçu pour les piscines enterrées. Il nettoie les escaliers et les angles, contrairement au nettoyeur de fond automatique. Il est muni d'un réservoir amovible de grande capacité et il incorpore un filtre qui retient les particules de petite taille. Léger et facile à manipuler. Rechargeable et sans câbles: il fonctionne avec un accumulateur lithium rechargeable de 11,1 V. Il peut être utilisé avec sa poignée ou bien connecté à une perche.

Particolarmente indicato per piscine interrate, pulisce le scalette e gli angoli che il pulitore automatico non riesce a raggiungere. È dotato di un capiente serbatoio removibile e di un filtro in grado di trattenerne le particelle più piccole. Leggero e maneggevole. Ricaricabile e senza fili: funziona con batteria al litio ricaricabile da 11,1V.

■ material de limpieza ■ cleaning material

POOL & SPA VAC

REF. CSPA

CBX PACK 2



8 412081 265315

Limpiafondos para piscinas y spas con mango. Recargable y sin cables. Posibilidad de uso con su propio mango o conectado a una pértiga. Ligero y manejable.

Nettoyeur de fond pour piscines et spas avec manche. Rechargeable et sans câbles. Il peut être utilisé avec sa poignée ou bien connecté à une perche. Léger et facile à manipuler.

Pool and spa vac with handle. Rechargeable and without cables. Possibilities of use with its own handle or connected to a pole. Lightweight and easy to use.

Pulitore per fondo piscina e spa con manico. Ricaricabile e senza fili. Può essere utilizzato con il manico in dotazione o collegato a un'asta.



STICK VAC

REF. VCB08

CBX PACK 2



8 412081 272535

Limpiafondos eléctrico para piscinas y Spa. Limpiador eléctrico autónomo. Potencia: 10 W. Sin cables. Necesita 8 baterías AA. Poste de extensión de 1,65 m incluido. Peso ligero, fácil manejo. Sin cables.

Nettoyeur électrique pour piscines et spas. Fonctionne en toute autonomie. Puissance: 10 W. Sans câbles. Nécessite 8 piles AA. Perche extensible de 1,65 m inclus. Poids léger, manipulation facile.

Pool and spa electric cleaner. Autonomous electric cleaner. Power: 10 W. Without cables. 8 pieces of AA battery needed. Extension pole of 1,65 m included. Lightweight, easy to handle. Without cables.

Pulitore elettrico per piscine e Spa. Pulitore elettrico autonomo - Potenza: 10 W. Senza cavo. Necessita di 8 batterie AA. Asta estensibile di 1,65 m inclusa. Peso leggero, facile da maneggiare. Senza cavi.



REF. ABS3

CBX PACK 1



8 412081 302751

Limpiafondos de batería para piscinas y spas con mango telescópico. Sin cables. Pértiga extensible de 133 cm incluida. Ligero y manejable.

Nettoyeur de fond à batterie pour piscines et spas avec manche télescopique. Sans câbles. Perche extensible de 133 cm incluse. Léger et maniable.

Battery powered pool and spa cleaner with telescopic handle. No cables. Extendible handle of 133 cm included. Lightweight and easy to handle.

Puliscifondo a batteria per piscine e spa con manico telescopico. Senza fili. Prolunga per manico estensibile da 133 cm inclusa. Leggero e maneggevole.



LIMPIAFONDOS AUTOMÁTICOS AUTOMATIC CLEANERS
NETTOYEURS AUTOMATIQUES PULISCIFONDI AUTOMATICI



PROFESSIONAL VAC
REF. 19007

9,6m - Ø 38

CBX PACK 1



8 427370 190070

Limpiafondos automático de membrana. Limpia el fondo y las paredes de cualquier piscina. Funciona con sistemas de filtración de una potencia mínima de 0,33CV.

Automatic pool cleaner with membrane system. The Professional Vac cleans the bottom and walls of your pool. Works with 0,33 hp minimum.

Nettoyeur automatique avec système unique de membrane. Nettoie le fond et les parois de la piscine. Il fonctionne avec des systèmes de filtration d'une puissance minimum de 0,33cv.

Puliscifondo automatico con sistema a membrana. Il Professional Vac pulisce il fondo e le pareti della piscina. Funziona con sistemi di filtrazione che hanno una potenza minima di 0,33cv.



Max. 1,80m



SILENCE VAC
REF. 90397

9,6m - Ø 38

CBX PACK 2



8 427370 903977

Limpiafondos automático más silencioso que los sistemas tradicionales de "martillo". Limpia el fondo y las paredes de su piscina. Funciona con sistemas de filtración de una potencia mínima de ½cv y máxima de 1½cv.

Automatic pool cleaner which is quieter than the traditional "hammer" systems. The Silence Vac cleans the bottom and walls of your pool. Works with ½ hp minimum and 1½hp maximum power filtration systems.

Nettoyeur automatique plus silencieux que les systèmes traditionnels à "marteau". Nettoie le fond et les parois de la piscine. Il fonctionne avec des systèmes de filtration d'une puissance minimum de ½cv et maximale de 1CV 1/2.

Puliscifondo automatico più silenzioso dei sistemi tradizionali a "martello". Il Silence Vac pulisce il fondo e le pareti della piscina. Funziona con sistemi di filtrazione che hanno una potenza minima di ½cv e massima di 1½cv.

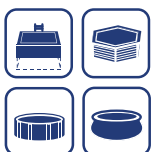

CLASSIC VAC
REF. 19001

8m - Ø 38

CBX PACK 1



8 427370 190018

Limpiafondos automático para piscinas enterradas y elevadas dotadas de un equipo de filtración con una bomba de una potencia mínima de 3/4 cv.

Automatic pool cleaner for in ground and above ground pools equipped with filtering equipment with a minimum power pump of 3/4 hp.

Nettoyeur automatique pour piscines enterrées et hors-sol équipées d'une filtration avec une pompe d'une puissance minimum de 3/4cv.

Puliscifondo automatico per piscine interrate e fuori terra dotate di un sistema di filtrazione con una potenza minima di 3/4 cv.

■ material de limpieza ■ cleaning material

WIKI VAC REF. 90399

6m - Ø 32

CBX PACK 2



8 427370 903991

Limpiafondos automático para piscinas autoportantes y elevadas. Funciona con equipos de filtración de baja potencia: a partir de 0,1cv. Dispone de un prefiltro exclusivo que permite proteger el cartucho y la filtración.

Nettoyeur automatique pour piscines autoportantes et hors-sol. Il fonctionne avec des systèmes de filtration de très faible puissance: à partir de 0,1cv minimum. Il dispose d'un pré-filtre exclusif qui protège la cartouche et la filtration.

The automatic pool cleaner for inflatable or above ground pools. Works with low-power filtering equipment: ranging from 0.1hp. It has a unique pre-filter which protects the cartridge and filtration.

Puliscifondo per piscine autoportanti e fuoriterra. Funziona con un sistema di filtrazione a partire da 0,1 cv di potenza. E' dotato di un prefiltro esclusivo che permette una maggior cura della cartuccia e della filtrazione.



SMALL CONFORT REF. AR20682

6m - Ø 32

CBX PACK 4



8 412081 232287

Limpiafondos automático por aspiración. Se conecta directamente al skimmer y es compatible con bombas a partir de 1/3CV.

Nettoyeur de fond automatique par aspiration. Il se branche directement sur le skimmer et il est compatible avec des pompes à partir de 1/3 de CV.

Automatic suction pool cleaner that is directly connected to the skimmer. Compatible with pumps from 1/3HP.

Puliscifondo automatico ad aspirazione. Si collega direttamente allo skimmer ed è compatibile con pompe a partire da 1/3CV.



REF. PFAC17

CBX PACK 4



8 412081 302744

Prefiltro para limpiafondos de aspiración. Conector de manguera giratorio incluido. Contenedor transparente que permite saber cuándo esta lleno. Capacidad de 1,7 litros.

Pré-filtre pour aspirateur. Raccord de tuyau rotatif inclus. Contenant transparent qui vous permet de savoir quand il est plein. Capacité de 1,7 litres.

Prefilter to be used with suction cleaners. Big capacity prefilter. Swivel hose connector included. Clear container allows to see when basket is full. 1,7 liters capacity.

Prefiltro per Puliscifondo. Connettore per tubo flessibile incluso. Contenitore trasparente che ti consente di sapere quando è pieno. Capacità di 1,7 litri.



LIMPIAFONDOS DE ASPIRACIÓN MANUAL VACUUM CLEANERS

NETTOYEURS À ASPIRATION MANUELLE PULITORI AD ASPIRAZIONE MANUALE



MEDIUM VAC

REF. AR20637

0 9m - Ø 32

CBX PACK 6



8 412081 231099

Kit de mantenimiento para piscinas autoportantes o elevadas. Contiene dos boquillas (una de ellas con cepillo).

Maintenance kit for inflatable or above ground pools. The pool cleaner includes: two suction nozzles, one with a brush.

Kit d'entretien pour piscines autoportantes ou hors-sol. Contient: un aspirateur de fond à aspiration manuelle qui inclut deux embouts.

Kit di mantenimento per piscine autoportanti o fuori terra. Contiene due aspiratori, uno con pennello



LITTLE VAC

REF. 08011A

0 5m - Ø 32

CBX PACK 6



8 427370 080111

Kit de mantenimiento para piscinas autoportantes o elevadas.

Maintenance kit for inflatable or above ground pools.

Kit d'entretien pour piscines autoportantes ou hors-sol.

Kit di mantenimento per piscine autoportanti o fuori terra.

■ material de limpieza ■ cleaning material

KITS LIMPIAFONDOS VACUUM CLEANER KITS

KITS DE NETTOYAGE KIT PULITORI FONDO AD ASPIRAZIONE

REF. AR20641

CBX PACK 2



8 412081 224718

Limpiafondos para pértiga + pértiga 3 secciones + recogedor de fondo + termómetro flotante + dosificador oval + cepillo para liner + manguera 6m + bote de tiras reactivas (tester)

Pack d'entretien comprenant: un nettoyeur de fond + un manche télescopique 3 sections + une époussette de fond + un thermomètre flottant + un diffuseur de chlore pour galets de 200gr + une brosse pour liner + un tuyau de 6m + une boîte de bandelettes de test

Bottom cleaner for pole + 3 section pole + leaf rake + floating thermometer + oval dispenser + brush for liner + 6m hose + can of reactive test strips (tester)

Puliscifondi + pertica 3 sezioni + raccogliatore di fondo + termometro galleggiante + dosatore ovale + spazzola per liner + 6m tubo + confezione da striscie reattive (tester)



REF. AR2064

CBX PACK 4



8 412081 202433

Kit limpiafondos + pértiga 3,60m (3x1,20m) + manguera 6m

Kit d'entretien comprenant : une tête de balai avec brosses latérales + un manche télescopique 3,60m (3x1,20m) + un tuyau de 6 m

Vacuum head kit + handle 3,60m (3x1,20m) + 6m hose

Kit puliscifondo + pertica 3,60m (3x1,20m) + tubo 6m



REF. KMA05

CS PACK 6



8 412081 237664

Kit mantenimiento piscinas: analizador pH/Cl, cepillo 45 cm, recogehojas superficie, termómetro y limpiafondos

Kit d'entretien pour piscines comprenant : une trousse d'analyse pH/Cl, une brosse 45 cm, une époussette de surface, un thermomètre et une tête de balai manuel

Pool maintenance kit: pH/Cl Test kit, 45 cm Brush, leaf net, thermometer and Vacuum head

Kit di mantenimento per piscine: analizzatore ph/cl, spazzola 45 cm, raccogliatore di superficie, termometro e puliscifondo



REF. KMSPA

CS PACK 6



8 412081 264967

Kit mantenimiento para spa hinchable o rígido. Incluye: Recogehojas · cepillo · Esponja de la línea de flotación · Pértiga

Kit de nettoyage pour spa gonflable ou rigide comprenant : une époussette, une brosse, une éponge pour la ligne d'eau et un manche télescopique.

Maintenance kit for Inflatable and rigid spas. Includes: Leaf skimmer · Brush · Water line cleaner sponge · Pole

Mantenimento per spa gonfiabili o parete rigida. Include: Raccogliatore · Spazzola · Spugne per la linea di galleggiamento · Pertica



■ matériel de nettoyage ■ materiale di pulizia

LIMPIAFONDOS VENTURY VENTURY VACUUM

ASPIRATEURS DE FOND VENTURY PULISCIFONDI VENTURY



REF. 08050

CS PACK 6



Kit piscina autoportante:
analyzer pH/Cl, cepillo,
recogehojas de superficie,
mango 1,20m (3 tramos)
termómetro tubular,
dosificador y jet vac ventury.

Special inflatable pool
kit: pH/chlorine test kit,
brush, leaf net, tubular
thermometer, 1,20m
handle (3 sections), floating
dispenser and ventury
vacuum.

Kit spécial piscine
autoportante: trousse
d'analyse pH/Cl, brosse,
épuisette de surface, manche
1,20m (3 parties), thermomètre
tubulaire, doseur pastilles
rétractable and jet vac ventury.

Kit speciale per piscina
autoportante: analizzatore
pH/Cl, spazzola, Raccogliatore
di superficie, manico 1,20m
(3 sezioni) termometro
tubolare, dosatore e
aspiratore jet vac ventury.



REF. 90111

DIS 3/4N PACK 8



Limpiafondos Micro-Ventury.
Nettoyeur Micro-Venturi.

Micro-Ventury Vacuum.
Puliscifondi Micro-Ventury.



REF. Y12

CS PACK 50



2 filtros para
limpiafondos ventury
2 sacs filtrants pour
aspirateur de fond
Ventury,

2 filters for ventury
bottom cleaner
2 filtri per puliscifondo venturi

■ material de limpieza ■ cleaning material

SERIE GRAPHITE GRAPHITE SERIE
GAMME GRAPHITE GAMMA GRAPHITE

Recogehojas de superficie Leaf net
 Épuisette de surface Raccoglitore di superficie

REF. LSP40

CB PACK 6



Recogehojas de fondo Leaf rake
 Épuisette de fond Raccoglitore di fondo

REF. LRP40

CB PACK 6



Limpiafondos triangular Triangular suction pool cleaner
 Balai triangulaire Puliscifondo triangolare

REF. VHTP40

CB PACK 6



Limpiafondos rectangular Rectangular vacuum head
 Balai rectangulaire Puliscifondo rettangolare

REF. VHRP40

CB PACK 6



Ø 5x360 cm
 Mango telescópico de aluminio Telescopic aluminium handle
 Manche télescopique Manico telescopico
 argenté argentato

REF. TPP360

CB PACK 6



■ matériel de nettoyage ■ materiale di pulizia

Graphite
SERIES



Cepillo 45 cm
Brosse 45 cm

45 cm brushes
Spazzole 45 cm

REF. WBP45

CS PACK 6



Cepillo 25 cm
Brosse 25 cm

25 cm brushes
Spazzole 25 cm

REF. WBP25

CS PACK 6



Dosificador flotante
pastillas 250gr
Doseur flottant pour
pastilles 250 g

Tablets floating
dispenser 250gr
Dosatore galleggiante
pastiglie da 250 g

REF. FDP250

CB PACK 12



Dosificador flotante
pastillas 20gr
Doseur flottant pour
pastilles 20 g

Tablets floating
dispenser 20gr
Dosatore galleggiante
pastiglie da 20 g

REF. FDP20

CB PACK 12



Cepillo manual
multifunción
Brosse manuelle
multifonction

Multi-function
manual brush
Spazzola manuale
multifunzione

REF. HBP20

CS PACK 6



Termómetro digital
flotante
Thermomètre digital
flottant

Floating digital
thermometer
Termometro digitale
galleggiante

REF. THP24

CS PACK 9



■ material de limpieza ■ cleaning material

BOX
REF.BGRA10 DIS PACK 1



■ matériel de nettoyage ■ materiale di pulizia

Graphite
SERIES



REF	N°	Descripción Describe Désignation Descrizione	CTD	EAN 13
FDP20	1	Dosificador 20g Dispenser 20g Diffuseur 20g Desatore 20g	12	8 412081 302850
HBP20	2	Cepillo manual Hand brush Brosse à main Spazzola manuale	6	8 412081 302805
WBP25	3	Cepillo 25 cm 25 cm brush Brosse 25 cm Spazzola 25 cm	6	8 412081 302829
FDP250	4	Dosificador 250g Dispenser 250g Diffuseur 250g Desatore 250g	12	8 412081 302843
WBP45	5	Cepillo 45 cm 45 cm brush Brosse 45 cm Spazzola 45 cm	6	8 412081 302812
LRP40	6	Recogehojas fondo Leaf rake Époussette de fond Raccoglitore di fondo	6	8 412081 302881
LSP40	7	Recogehojas superficie Leaf net Époussette de surface Raccoglitore superficie	6	8 412081 302874
VHRP40	8	Limpiafondos rectangular Rectangular vacuum head Tête de balai rectangulaire Puliscifondo rettangolare	6	8 412081 302898
THP24	9	Termómetros Thermometer Thermomètre Termometro	9	8 412081 302836
VHTP40	10	Limpiafondos triangular Triangular vacuum head Tête de balai triangulaire Puliscifondo triangolare	6	8 412081 302904

■ material de limpieza ■ cleaning material

GAMA CONFORT CONFORT RANGE
GAMME CONFORT GAMMA CONFORT

Recogehojas de superficie
 Gama confort

Épuisette de surface
 Gamme confort

Confort range
 Leaf net

Raccoglitore di superficie
 Gamma confort



REF. 40030N

DISPACK 12



8 412081 272962

Recogehojas de fondo
 Gama confort

Épuisette de fond
 Gamme confort

Confort range
 leaf rake

Raccoglitore di fondo
 Gamma confort



REF. 40032N

DIS PACK 12



8 412081 272955

Recogehojas
 superficie aluminio

Épuisette de surface
 aluminium

Aluminium
 Leaf net

Raccoglitore di
 superficie alluminio



REF. RHSALN

DIS PACK 12



8 412081 272979

Recogehojas fondo
 aluminio

Épuisette de fond
 aluminium

Aluminium
 Leaf rake

Raccoglitore di
 fondo alluminio



REF. RHFALN

DIS PACK 12



8 412081 272986

Termómetro UFO
 Thermomètre UFO

UFO thermometer
 Termometro UFO



REF. TTUFO

DIS PACK 12



8 412081 273068

Colgador metálico para
 material de limpieza

Support mural en métal
 pour le rangement du
 matériel

Metalic hanger for
 cleaning material

Portautensili metallico
 per attrezzi di pulizia



REF. BHM5

BX PACK 6



8 412081 273075

■ matériel de nettoyage ■ materiale di pulizia



Cepillo 50 cm
Brosse 50 cm

50 cm brushes
Spazzole 50 cm

REF. 40041N

DIS PACK 12



8 412081 273013



Cepillo 30 cm
Brosse 30 cm

30 cm brushes
Spazzole 30 cm

REF. 40041SN

DIS PACK 12



8 412081 273020



Cepillo aluminio
Gran formato 50 cm
Brosse aluminium
Grand Format 50 cm

Big Format 50 cm
Aluminium brush
Spazzola alluminio
Gran Formato 50 cm

REF. 40046N

DIS PACK 12



8 412081 272993



Limpiafondos triangular
rotativo con cepillos
Tête de balai triangulaire
rotative avec brosses

Triangular swivelling vac
head with brushes
Puliscifondo triangolare
rotante con spazzole

REF. 40016N

DIS PACK 4



8 412081 273044



Limpiafondos ovalado
rotativo con cepillos
Tête de balai ovale rotative
avec brosses

Oval swivelling vac head
with brushes
Puliscifondo ovale rotante
con spazzole

REF. 40017N

DIS PACK 6



8 412081 273037



Limpiafondos manual rotativo
8 ruedas con cepillos laterales
Tête de balai manuel rotative 8
roues avec brosses latérales

Swivelling vacuum head 8
wheels with lateral brushes
Puliscifondo manuale con 8
ruote e spazzole laterali

REF. 40018N

DIS PACK 6



8 412081 273051



Cepillo manual
multifunción
Brosse manuelle
multifonction

Multifunctional
manual brush
Spazzola manuale
multifunzione

REF. 40040N

DIS PACK 12



8 412081 273006

■ material de limpieza ■ cleaning material

RECOGEHOJAS LEAF NETS AND RAKES ÉPUISETTES RACCOGLITORI

Recogehojas de fondo
+ mango telescópico
Épuiette de fond
+ manche télescopique

Leaf rake
+ telescopic handle
Raccoglitore di fondo
+ Manico telescopico

REF. 40031F

CB PACK 12



Recogehojas de
superficie + mango
telescópico

Leaf net
+ telescopic handle

Épuiette de surface
+ manche télescopique

Raccoglitore di superficie
+ Manico telescopico

REF. 40031

CB PACK 12



LIMPIAFONDOS MANUALES VACUUM HEADS BALAIS MANUELS PULISCIFONDO MANUALI

Limpiafondos de
aluminio

Aluminium vac
head

Balai en
aluminium

Alluminio
puliscifondo

REF. 40022

BX PACK 6

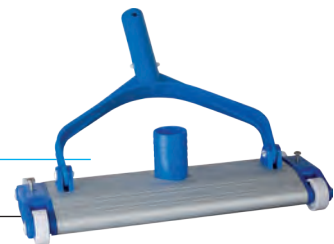

Empuñadura clip
Ø28mm

Clip handle
Ø28mm

Poignée clip
Ø28mm

Impugnatura clip
Ø28mm

REF. 40092

DIS 1/4N pack 6

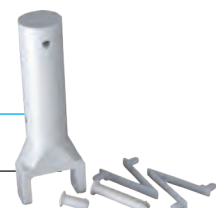

■ matériel de nettoyage ■ materiale di pulizia

CEPILLOS BRUSHES
BROSSES SPAZZOLE



Cepillo aluminio para eliminar algas
Brosse en aluminium pour éliminer les algues.

Aluminium brush to eliminate the algae
Spazzola alluminio per eliminare le alghe



REF. CAA25

DIS 1/4N pack 16



Cepillo aspirante
Brosse aspirante

Vacuum brush
Spazzola con attacco per aspirare



REF. 40802

DIS 3/4N pack 10



Cepillo aspirador limpia-esquinas
Brosse aspirante d'angle

Corners-cleaner vacuum brush
Spazzola aspiratutto per angoli



REF. 40806

DIS 1/4N pack 18



ESPONJAS SPONGES
EPONGES SPUGNE

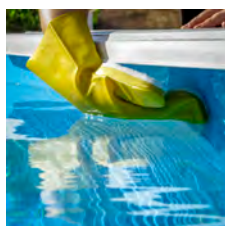

Guante con esponja para limpiar la línea de flotación

Glove with cleaning sponge for water line

Gant avec éponge pour le nettoyage de la ligne de flottaison sur le liner

Guanto in spugna per pulire la linea di galleggiamento

REF. GFL5

CB pack 24



Esponjas mágicas para la línea de flotación
4 unidades

Water line cleaner magic sponges
4 units

Eponges magiques nettoyant la ligne d'eau
4 unités

Spugne magiche per la linea di galleggiamento
4 unità

REF. PGL4

DIS pack 12



Esponja de la línea de flotación
Eponge à main ligne d'eau

Water line cleaner sponges
Spugne per la linea di galleggiamento

REF. 770334

CB PACK 6



■ material de limpieza ■ cleaning material

TERMÓMETROS THERMOMETERS
THERMOMÈTRES TERMOMETRI

Termómetro pez payaso
Thermomètre de type
poisson clown

Clown fish thermometer
Termometro pesce
pagliaccio



REF. TBF20

BXL PACK 12



Termómetro bola
Thermomètre boule

Ball thermometer
Termometro a sfera



REF. 40055

CB pack 15



Termómetro boya
Thermomètre bouée

Buoy thermometer
Termometro galleggiante



REF. 40054

DIS 1/2N pack 10



Termómetro tubular
flotante
Thermomètre flottant
tubulaire

Tubular floating
thermometer
Termometro tubolare



REF. 40051

DIS 1/2N PACK 18



Termómetro "Big"
Doble lectura
Thermomètre "Big"
Double lecture

"Big" thermometer
Double reading
Termometro "Big"
Doppio lettura



REF. 40050

CS pack 12



■ matériel de nettoyage ■ materiale di pulizia

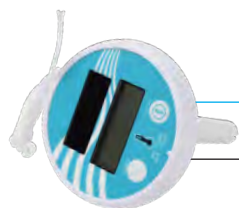

Termómetro digital
flotante
Thermomètre digital
flottant

Floating digital
thermometer
Termometro digitale
galleggiante



REF. 778204

CS PACK 12



Termómetros animal
Thermomètres animaux

Animals thermometer
Termometro animale

REF. 770326

DIS PACK 12



Kit mantenimiento
6 accesorios
Kit entretien
6 accessoires

Maintenance kit
6 accessories
Kit manutenzione
6 accessori

REF. 784880

CS PACK 6



Aspirador cepillo media
luna efecto venturi + bolsa

Jet vac with brush
and bag

Aspirateur brosse demi-lune
effet venturi + sac

Aspiratore con spazzola a
mezzaluna effetto venturi



REF. 772794

CS PACK 6



Bolsa de recambio aspirador
venturi modelo pequeño
Sac de rechange pour
aspirateur venturi petit
modèle

Replacement bag
for jet vac
Sacca di ricambio
per aspiratore venturi
modello piccolo

REF. 770344

PB PACK 24



■ material de limpieza ■ cleaning material

DOSIFICADORES DISPENSERS DIFFUSEURS DE CHLORE DOSATORI

Combi Thermo-dosificador: Dosificador Capacidad 1,5 Kg (pastillas de 20 a 500 g) + Termómetro + Visor de consumo de producto

Combi Thermo-dosifier: Dosifier Capacity 1,5 kg (20 500 g tablets) + Thermometer + Product Consumption Viewer

Combi Thermo-doseur: doseur avec une capacité de 1,5 Kg (pastilles de 20 à 500 g) + thermomètre + témoin de consommation du produit

Combi Thermo-Dosatore Capacità 1,5 kg (Tavolette da 20 a 500 g) + Termometro + Controllo livello del prodotto

REF. 40070

DIS 1/2N PACK 5



8 427370 400704



Combi Thermo-dosificador: Dosificador pastillas de 20 g + Termómetro + Visor de consumo de producto

Combi Thermo-dosifier: Dosifier 20g tablets + Thermometer + Product Consumption Viewer

Combi Thermo-doseur: doseur pour pastilles de 20 g + thermomètre + témoin de consommation du produit

Combi Thermo-Dosatore Tavolette da 20 g + Termometro + Controllo livello del prodotto

REF. DCT20

DIS 1/2N PACK 36



8 412081 241463



Dosificador flotante. Capacidad: 7 pastillas de 20 g

Floating dispenser. Capacity: 7 tablets 20 g

Doseur flottant. Capacité 7 pastilles de 20 g

Dosatore galleggiante. Capacità 7 pastiglie da 20 g

REF. 40071

DIS 1/2N PACK 30



8 427370 400711



■ matériel de nettoyage ■ materiale di pulizia

MANGOS TELESCÓPICOS TELESCOPIC HANDLES
MANCHES TÉLESCOPIQUES MANICO TELESCOPICO

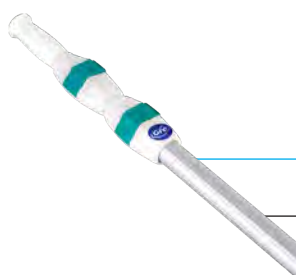

Mango telescópico de aluminio
Manche télescopique argenté
3,60 m (3 x 1,20m)

Telescopic aluminium handle
Manico telescopico argentato

REF. 40014

BX pack 12



8 427370 400148



Mango telescópico de aluminio
Manche télescopique argenté
4,80 m (2 x 2,40m)

Telescopic aluminium handle
Manico telescopico argentato

REF. 40011

BX pack 10



8 427370 400117



Mango telescópico de aluminio
Manche télescopique argenté
3,60 m (2 x 1,80m)

Telescopic aluminium handle
Manico telescopico argentato

REF. 40010

BX pack 10



8 427370 400100



Mango telescópico de aluminio
Manche télescopique argenté
2,40 m (2 x 1,20m)

Telescopic aluminium handle
Manico telescopico argentato

REF. 40013

BX pack 20



8 427370 400131

■ material de limpieza ■ cleaning material

CARDBOARD RANGE

Recogehojas de superficie clásico
Épuiette de surface classique

Classic
Leaf net
Raccogliatore di superficie classico

REF. 772804

CB PACK 12



Recogehojas de superficie profesional
Épuiette de surface professionnelle

Professional
Leaf net
Raccogliatore di superficie professionale

REF. 772868

CB PACK 12



Recogehojas de superficie + mango aluminio
Épuiette de surface + manche en aluminium

Leaf net + aluminium telescopic handle
Raccogliatore di superficie + Manico telescopico alluminio

REF. 772899

CB PACK 12



Recogehojas fondo clásico
Épuiette de fond classique

Classic
Leaf rake
Raccogliatore di fondo classico

REF. 777580

CB PACK 12



Recogehojas fondo profesional
Épuiette de fond professionnelle

Professional
Leaf rake
Raccogliatore di fondo professionale

REF. 772872

CB PACK 12



■ matériel de nettoyage ■ materiale di pulizia



Limpiafondos triangular rotativo con cepillos
Tête de balai triangulaire rotative avec brosses

Triangular swivelling vac head with brushes
Puliscifondo triangolare rotante con spazzole



REF. 777584

CS PACK 6



Limpiafondos ovalado rotativo con cepillos
Tête de balai ovale rotative avec brosses

Oval swivelling vac head with brushes
Puliscifondo ovale rotante con spazzole

REF. 770306

CS PACK 6



Limpiafondos rotativo 8 ruedas con cepillos laterales
Tête de balai rotative 8 roues avec brosses latérales

Swivelling vacuum head 8 wheels with lateral brushes
Puliscifondo con 8 ruote e spazzole laterali



REF. 777573

CS PACK 6



Limpiafondos media luna clásico
Tête de balai demi-lune classique

Half moon vacuum head classic
Puliscifondo mezza luna



REF. 777970

CS PACK 6



Cepillo aluminio Gran formato 45 cm
Brosse aluminium Grand Format 45 cm

Big Format 45 cm Aluminium brush
Spazzola alluminio Gran Formato 45 cm



REF. 772877

CB PACK 6



Cepillo de pared clásico de 45 cm
Brosse de paroi classique 45 cm

45 cm classic wall brush
Spazzola parete classico 45 cm

REF. 772876

CB PACK 12



■ material de limpieza ■ cleaning material

BOX

REF.786500

DIS PACK 1



■ matériel de nettoyage ■ materiale di pulizia

REF	N°	Descripción Description Désignation Descrizione	CTD	EAN 13
778191	1	Dosificador. Dispenser. Diffuseur. Dosatore	24	 3 605217 781918
621201	2	Kit reparación liner. Liner repair kit. Kit réparation liner. Kit riparazione liner	36	 3 605216 212017
777580	3	Recogehojas fondo. Leaf rake. Époussette de fond. Raccogliatore di fondo	20	 3 605217 7775801
40068	4	Análisis cloro + pH + alcalinidad. Chlorine + pH + alkalinity analysis. Analyse chlore + pH + alcalinité. Analisi cloro + pH + alcalinità .	40	 8 427370 400681
783810	5	Recogehojas superficie. Leaf net. Époussette de surface. Raccogliatore superficie	12	 3 605217 838100
772804	6	Recogehojas superficie PVC. PVC Leaf net. Époussette de surface PVC. Raccogliatore superficie PVC	20	 3 605217 728043
778201	7	Termómetro 16 cm. thermometer 16 cm. Thermomètre 16 cm. Termometro 16 cm.	33	 3 605217 782014
770340	8	Cepillo manual. Hand brush. Brosse à main. Spazzola manuale	21	 3 605217 703408
770326	9	Termómetros animal. Animals thermometer. Thermomètres animaux Termometro animale	12	 3 605217 703262
772876	10	Cepillo de pared 45 cm. 45 cm wall brush. Brosse de paroi 45 cm. Spazzola parete 45 cm	12	 3 605217 728760
778192	11	Dosificador flotante. Tablets floating dispenser. Diffuseur flottant pour galets Dosatore galleggiante.	12	 3 605217 781925
770342	12	Mango telescópico. Telescopic handle. Manche télescopique. Manico telescopico	16	 3 605217 703422

■ material de limpieza ■ cleaning material

ECO RANGE



Recogehojas de superficie Leaf net
Époussette de surface Raccoglitore di superficie

REF. 90115

DIS 3/4N PACK 24



Recogehojas de superficie + Leaf net + handle
mango 122cm 122cm

Époussette de surface Raccoglitore di superficie
+ manche 122cm + manico 122cm

REF. 90117

CB PACK 24

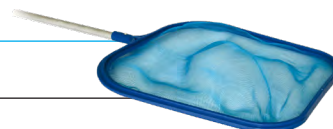

Recogehojas fondo Leaf rake
Époussette de fond Raccoglitore di fondo

REF. 90120

DIS 3/4N PACK 16



Recogehojas de superficie + Leaf net + 5 section
mango 5secciones 160 cm pole 160 cm

Époussette de surface + Raccoglitore di superficie +
manche 5 sections 160cm manico sezionabile 160cm

REF. 90184

CB PACK 12



Mango telescópico Telescopic handle
3 x 120 cm 3 x 120 cm

Manche télescopique Manico telescopico
3 x 120 cm 3 x 120 cm

REF. 90100

CB PACK 10

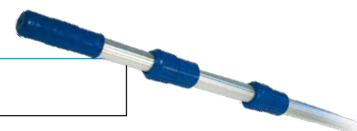

Limpiafondos 1/2 luna Vacuum head
Balai demi-lune Puliscifondo

REF. 90105

DIS 1/2N PACK 12



Aspirador cepillo media Jet vac with brush
luna

Aspirateur brosse Aspiratore con spazzola a
demi-lune mezzaluna

REF. 90110

DIS 3/4N PACK 8



Manguera limpiafondos Vacuum hose 9m
9m Ø38mm Ø38mm

Tuyau pour nettoyeur 9m Tubo puliscifondo 9m
Ø38mm Ø38mm

REF. 90135

BX pack 1



■ matériel de nettoyage ■ materiale di pulizia



Cepillo de 45 cm
Brosse 45 cm

45 cm brush
Spazzola 45 cm

REF. 90127 **DIS 3/4N PACK 24** 8 427370 901270



Cepillo de 20 cm
Brosse 20 cm

20 cm brush
Spazzola 20 cm

REF. 90125 **DIS 1/4N PACK 16** 8 427370 901256



Cepillo línea de agua
Brosse ligne d'eau

Waterline brush
Spazzola per bordo acqua

REF. 90128 **DIS 1/4N PACK 36** 8 427370 901287

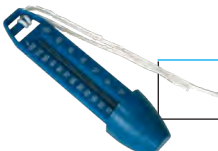

Termómetro universal
Thermomètre universel

Universal thermometer
Termometro universale

REF. 90130 **DIS 1/4N PACK 30** 8 427370 901300



Termómetros animal
Thermomètre animaux

Animals thermometer
Termometro animale

REF. 90132 **DIS 1/4N PACK 60** 8 427370 901324



Dosificador flotante.
tabletas 200 gr
Doseur flottant pour
galets 200 gr

Tablets floating
dispenser 200 gr
Dosatore galleggiante.
pastiglie 200 gr

REF. 90140 **DIS 3/4N PACK 12** 8 427370 901409



Dosificador de pastillas 20 gr
Doseur pour pastilles 20 gr

Tablets dispenser 20 gr
Dosatore pastiglie 20 gr

REF. 90141 **DIS 3/4N PACK 40** 8 427370 901416



Analizador de cloro/bromo +
pH (Oto/Phenol)

Test kit chlorine/bromine +
pH (Oto/Phenol)

Trousse d'analyse chlore/
brome + pH (Oto/Phénol)

Kit analisi cloro/bromo +
pH (oto/Phenol)

REF. 90180 **DIS 1/4N PACK 32** 8 427370 901805



Recambio Oto/Phenol
Recharge Oto/Phénol

Test kit Oto/Phenol
Ricambio Oto/Phenol

REF. 90181 **DIS 1/4N PACK 60** 8 427370 901812

■ material de limpieza ■ cleaning material

BOX

REF.90197N DIS PACK 1



REF	N°	Descripción Desription Désignation Descrizione	CTD	EAN 13
90127	1	Cepillo de 45 cm 45 cm brush Brosse 45 cm Spazzola 45 cm	12	8 427370 901270
770326	2	Termómetros animal Animals thermometer Thermomètre animaux Termometro animale	12	3 605217 703262
90141	3	Dosificador de pastillas 20 g Tablets dispenser 20 g Doseur de pastilles 20 g Dosatore pastiglie 20 g	12	8 427370 901416
40068	4	Análisis cloro + pH + alcalinidad. Chlorine + pH + alkalinity analysis. Analyse chlore + pH + alcalinité. Analisi cloro + pH + alcalinità .	16	8 427370 400681
90140	5	Dosificador de tabletas 200 g Tablets dispenser 200 g Doseur de galets 200 g Dosatore pastiglie 200 g	12	8 427370 901409
40080	6	Kit reparación liner. Liner repair kit. Kit réparation liner. Kit riparazione liner	24	8 427370 400803
90105	7	Limpiafondos 1/2 luna Vacuum head Balai demi-lune Puliscifondo	6	8 427370 901058
40009	8	Unión 2 mangueras 2 vacuum hoses union Liaison pour tuyaux flottants Raccordo per unire 2 tubi	12	8 427370 400094
90120	9	Recogehojas fondo Leaf rake Époussette de fond Raccoglitore di fondo	16	8 427370 901201
90130	10	Termómetro Thermometer Thermomètre Termometro	15	8 427370 901300
90115	11	Recogehojas superficie Leaf net Époussette surface Raccoglitore superficie	16	8 427370 901157
90128	12	Cepillo manual Hand brush Brosse à main Spazzola manuale	18	8 427370 901287
90100	13	Mango telescópico Telescopic handle Manche télescopique Manico telescopico	10	8 427370 901003

■ matériel de nettoyage ■ materiale di pulizia

PROTECCIÓN INVIERNO WINTER PROTECTION
HIVERNAGE PROTEZIONE PER L'INVERNO



Flotador de hibernaje
Flotteur d'hivernage

Winterising fl oat
Galleggiante inverno

REF. 40580

BX PACK 10



Gizzmo - protección del
skimmer
Gizzmo - protection du
skimmer

Gizzmo - skimmer
protection
Gizzmo - protezione
per skimmer

REF. 40581

BX PACK 12



Tapón de invernaje 1,5"
Bouchon d'hivernage 1,5"

Winterising plug 1,5"
Tappo inverno 1,5"

REF. 40582

BX PACK 6



Tapón de invernaje 2"
Bouchon d'hivernage 2"

Winterising plug 2"
Tappo inverno 2"

REF. 40583

BX PACK 6



■ material de limpieza ■ cleaning material

MANGUERAS VACUUM HOSES TUYAUX FLOTTANTS TUBI GALLEGGIANTI

Manguera limpiafondos 15m con 2 terminales Ø38mm
Tuyau pour nettoyeur de fond 15m avec 2 embouts soudés Ø38mm

Vacuum hose 15m with 2 cuffs Ø38mm
Tubo puliscifondo 15m con 2 terminali da Ø38mm

REF. 40004

BX pack 1



8 427370 400049



Manguera limpiafondos 12m con 2 terminales Ø38mm
Tuyau pour nettoyeur de fond 12m avec 2 embouts soudés Ø38mm

Vacuum hose 12m with 2 cuffs Ø38mm
Tubo puliscifondo 12m con 2 terminali da Ø38mm

REF. 40003

BX pack 1



8 427370 400032



Manguera limpiafondos 10m con 2 terminales Ø38mm
Tuyau pour nettoyeur de fond 10m avec 2 embouts soudés Ø38mm

Vacuum hose 10m with 2 cuffs Ø38mm
Tubo puliscifondo 10m con 2 terminali da Ø38mm

REF. 40002

BX pack 1



8 427370 400025



Manguera limpiafondos 8m con 2 terminales Ø38mm
Tuyau pour nettoyeur de fond 8m avec 2 embouts soudés Ø38mm

Vacuum hose 8m with 2 cuffs Ø38mm
Tubo puliscifondo 8m con 2 terminali da Ø38mm

REF. 40001

BX pack 1



8 427370 400018



Manguera limpiafondos 6m con 2 terminales Ø38mm
Tuyau pour nettoyeur de fond 6m avec 2 embouts soudés Ø38mm

Vacuum hose 6m with 2 cuffs Ø38mm
Tubo puliscifondo 6m con 2 terminali da Ø38mm

REF. AR210

BX pack 1



8 412081 960296



■ matériel de nettoyage ■ materiale di pulizia



Manguera limpiafondos 4m
con 2 terminales Ø38mm

Tuyau pour nettoyeur de fond
4m avec 2 embouts soudés
Ø38mm

Vacuum hose 4m
with 2 cuffs Ø38mm

Tubo puliscifondo 4m
con 2 terminali da Ø38mm

REF. AR212

BX pack 1



8 4 1 2 0 8 1 2 4 0 8 2 4



Manguera limpiafondos 12m
con 2 terminales Ø32mm

Tuyau pour nettoyeur de fond
12m avec 2 embouts soudés
Ø32mm

Vacuum hose 12m
with 2 cuffs Ø32mm

Tubo puliscifondo 12m
con 2 terminali da Ø32mm

REF. 770323

BXL pack 1



3 6 0 5 2 1 7 7 0 3 2 3 1



Manguera limpiafondos 7m
con 2 terminales Ø32mm

Tuyau pour nettoyeur de fond
7m avec 2 embouts soudés
Ø32mm

Vacuum hose 7m
with 2 cuffs Ø32mm

Tubo puliscifondo 7m
con 2 terminali da Ø32mm

REF. 770322

BXL pack 1



3 6 0 5 2 1 7 7 0 3 2 2 4



Enrollador de mangueras
flotantes hasta 15m.
(Manguera no incluida)

Enrouleur de tuyaux
flottants. Jusqu'à 15m.
(Tuyau non inclus)

Vacuum hoses roller
maximum 15m.
(Vacuum hoses not included)

Avvolgitore per tubo
galleggiante fino a 15 m. (Tubo
non incluso)

REF. 90165

CBX PACK 1



8 4 2 7 3 7 0 9 0 1 6 5 2



Terminal manguera flotante -
Ø38mm

Embout tuyau flottant -
Ø38mm

Hose cuff - Ø38mm

Raccordo per tubo Ø38 mm

REF. 40012

BX PACK 12



8 4 2 7 3 7 0 4 0 0 1 2 4

chemicals

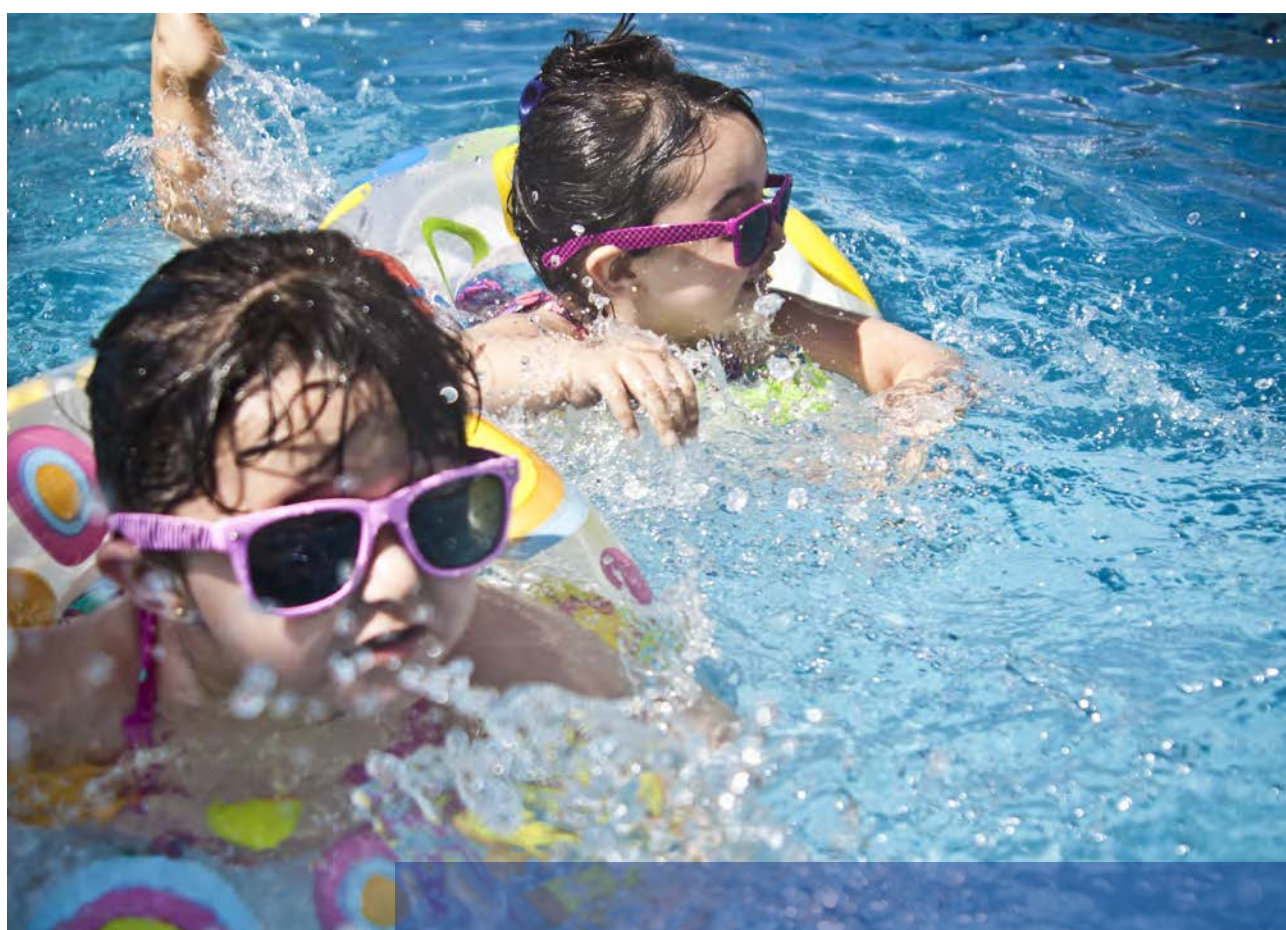



producto químico chemicals
produits d'entretien prodotti chimici



MADE
IN
EU

■ producto químico ■ chemicals

VIVE TU PISCINA Y SUMÉRGETE EN LA DIVERSIÓN

Para ello, es necesario utilizar en cada momento los productos adecuados para el buen mantenimiento del agua de la piscina. Gre lo pone fácil con su nueva gama.

Hay **3** etapas a seguir para realizar un correcto mantenimiento de la piscina. Las diferenciamos en:

- 1 Start** Es la etapa en la que hacemos un **tratamiento inicial** necesario para poner a punto la piscina para la temporada de baño.
- 2 Play** Es la etapa de baño. Debemos llevar a cabo un **tratamiento de mantenimiento** que es crucial para poder disfrutar de la piscina con total seguridad.
- 3 Stop** Es la etapa en la que dejamos de bañarnos y debemos **mantener la piscina hasta la nueva temporada**. Esta etapa es igual de importante que las otras, para mantener la piscina en perfecto estado.

Además de estas 3 etapas, hay que tener en cuenta los diferentes tipos de productos. Los diferenciamos por su color de familia:

- Equilibrio** Productos destinados a equilibrar los parámetros del agua: pH y alcalinidad
- Desinfección** Productos que mantienen el agua libre de microbios
- Algicidas** Productos para prevenir de las algas
- Floculantes** Productos para mantener el agua limpia y transparente
- Multiacción** Productos todo en uno
- Limpieza** Productos para limpiar los elementos de la piscina
- Invernaje** Productos para mantener la piscina durante el invierno

LIVE YOUR POOL AND DIVE INTO FUN!

To this end, it is essential to use the right products in every step for a well-maintained pool water. Gre makes it easy for you with its new range.

There are **3** steps to follow in order to ensure the proper maintenance of your pool. We differentiate them in:

- 1 Start** It is the step where we carry out the necessary **initial treatment** to start-up your pool for the bathing season.
- 2 Play** It is the bathing season. We must carry out the crucial **maintenance treatment** that guarantees utmost security while enjoying your pool.
- 3 Stop** It is the step where we stop bathing and we must **maintain the pool until next season**. This stage is equally important as the others in order to keep the pool in a perfect state.

Apart from these 3 steps, we have to take into account the different types of products. We differentiate them by their family color:

- Balance** Products destined to balance water parameters: pH and alkalinity
- Disinfection** Products that keep water microbe-free
- Algaecides** Products that prevent algae growth
- Flocculants** Products to keep water clean and transparent
- Multiaction** All-in-one products
- Cleaning** Products to clean the pool elements
- Wintering** Products to maintain the pool during the winter

La nueva imagen se ha desarrollado para facilitar el reconocimiento de marca y el fácil entendimiento del producto.

The new image has been developed to facilitate brand recognition and product understanding.

Logo en grande, tapas azules y gran mancha azul para facilitar el reconocimiento de marca
A big logo, blue lids and a large blue band to facilitate brand recognition
Un grand logo, des couvercles bleus et un grand aplat bleu pour faciliter l'identification de la marque
Logo di grandi dimensioni, coperchi azzurri e grande area azzurra per agevolare il riconoscimento del marchio

Nombre de producto
Product name
Nom du produit
Nome del prodotto

Descripción
Description
Description
Descrizione

Tipo de piscina
Pool type
Type de piscine
Tipo di piscina

Familia de producto
Product family
Famille de produit
Tipologia del prodotto

Etapas de uso
Usage stage
Étapes d'utilisation
Fase di utilizzo

Formato
Format
Format
Formato

Dosificación
Dosage
Dosage
Dosaggio

1 Start 2 Play 3 Stop

ChlorLent

1 tablet = 25 m³

■ produits d'entretien ■ prodotti chimici

PLONGEZ DANS L'UNIVERS DIVERTISSANT DE LA PISCINE

Afin de maintenir la qualité de l'eau de votre piscine, il est nécessaire de toujours utiliser les produits adéquats.

Il y a **3** étapes à suivre pour réaliser un entretien correct de votre piscine. Il s'agit de :

- 1 Start** C'est l'étape durant laquelle nous réalisons un **traitement initial** pour procéder à la mise en route de la piscine en début de saison.
- 2 Play** Durant la saison de baignade, nous devons effectuer un **traitement d'entretien** qui est essentiel pour pouvoir profiter pleinement de la piscine et en toute sécurité.
- 3 Stop** La troisième étape marque la fin de la saison de baignade où l'on doit **entretenir la piscine jusqu'à la prochaine saison**. Cette étape est tout aussi importante que les autres afin de maintenir votre piscine en parfait état.

En plus de ces 3 étapes, il faut tenir compte des différents types de produits. Nous les différencions par leurs couleurs de famille :

- Équilibre** Produits permettant d'équilibrer les paramètres de l'eau : pH et alcalinité
- Désinfection** Produits pour conserver une eau sans impuretés
- Algicides** Produits pour prévenir l'apparition d'algues
- Floculants** Produits pour maintenir une eau propre et transparente
- Multiaction** Produits tout-en-un
- Nettoyage** Produits pour nettoyer les différents éléments de la piscine
- Hivernage** Produits pour entretenir la piscine durant la période d'hivernage

La nouvelle identité visuelle a été pensée pour faciliter l'identification de la marque et permettre une meilleure compréhension de ses produits.

La nuova immagine è stata creata per agevolare il riconoscimento del marchio e per consentire una semplice comprensione del prodotto.



VIVI LA TUA PISCINA E IMMERSI NEL DIVERTIMENTO

A tal proposito è necessario utilizzare sempre prodotti idonei al corretto trattamento dell'acqua della piscina. Gre agevola questa operazione con la sua nuova gamma di prodotti.

Per effettuare una corretta manutenzione della piscina occorre seguire **3** fasi che vengono descritte a continuazione:

- 1 Start** Vi è una fase in cui viene eseguito un **trattamento iniziale** con la funzione di preparare la piscina per la stagione balneare.
- 2 Play** Vi è quindi la fase di utilizzo della piscina. Occorre effettuare un **trattamento di mantenimento** che è essenziale per poter utilizzare la piscina nella massima sicurezza.
- 3 Stop** Vi è quindi la fase in cui si smette di utilizzare la piscina ed occorre quindi effettuare la **manutenzione per preservarla fino alla stagione successiva**. Questa fase ha la medesima importanza delle altre due per mantenere la piscina in perfetto stato.

Oltre alle tre fasi occorre considerare le differenti tipologie di prodotto. Li differenziamo per tipologia:

- Equilibrio** Prodotti destinati a equilibrare i parametri dell'acqua: pH e alcalinità
- Disinfezione** Prodotti che mantengono l'acqua priva di microbi
- Algicidi** Prodotti per la prevenzione delle alghe
- Floculanti** Prodotti per mantenere l'acqua limpida e trasparente
- Multiazione** Prodotti tutto in uno
- Pulizia** Prodotti per la pulizia degli elementi della piscina
- Svernamento** Prodotti per la pulizia della piscina nella stagione invernale

BEFORE



AFTER



■ producto químico ■ chemicals

PASOS PARA CUIDAR DE SU PISCINA

STEPS TO TAKE CARE OF YOUR SWIMMING POOL

ÉTAPES À SUIVRE POUR PRENDRE SOIN DE VOTRE PISCINE

INDICAZIONI PER IL TRATTAMENTO DELLA PISCINA

1 Start

Tratamiento inicial para la puesta a punto

Initial treatment for the start-up

Traitement initial pour la mise en route de la piscine

Trattamento iniziale per la messa a punto

1- Limpieza del exterior de la piscina 1- Cleaning the pool surroundings

1- Nettoyage de l'extérieur de la piscine 1- Pulizia dell'esterno della piscina

LIMPIEZA · CLEANING · NETTOYAGE · PULIZIA

Waterline CLEANER	Eliminar la suciedad de la línea de flotación Remove dirt from the waterline Éliminer la saleté de la ligne d'eau Eliminare lo sporco dalla linea di galleggiamento
AntiCALC	Prevenir la formación de cal Prevent limescale Empêcher la formation de calcaire Prevenire la formazione del calcare

2- Limpieza del agua 2- Water cleaning

2- Nettoyage de l'eau 2- Pulizia dell'acqua

EQUILIBRIO · BALANCE · ÉQUILIBRE · EQUILIBRIO

pH MINUS, pH PLUS, Tac PLUS	Equilibrar los parámetros del agua Balance water parameters Équilibrer les paramètres de l'eau Equilibrare i parametri dell'acqua
-----------------------------------	--------------------------------------------------------------------------------------------------------------------------------------------

DESINFECCIÓN · DISINFECTION · DÉSINFECTION · DISINFEZIONE

ClorCHOC, BromCHOC	Tratamiento de choque para eliminar todos los gérmenes y contaminantes del agua Shock treatment to remove all germs and contaminants from the water Traitement de choc pour éliminer tous les germes et polluants de l'eau Trattamento choc per eliminare tutti i germi e le sostanze inquinanti dall'acqua
-----------------------	----------------------------------------------------------------------------------------------------------------------------------------------------------------------------------------------------------------------------------------------------------------------------------------------------------------------

FLOCULANTE · FLOCCULANT · FLOCULANT · FLOCCULANTE

Floculant	Clarificar el agua y mejorar el rendimiento de la filtración Clarify the water and improve the filter's performance Clarifier l'eau et améliorer la performance du filtre Rendere limpida l'acqua e migliorare la resa della filtrazione
-----------	---------------------------------------------------------------------------------------------------------------------------------------------------------------------------------------------------------------------------------------------------

■ productos de mantenimiento ■ prodotti chimici

2 Play

Tratamiento de mantenimiento Maintenance treatment

Traitement d'entretien Trattamento di mantenimento

EQUILIBRIO · BALANCE · ÉQUILIBRE · EQUILIBRIO

pH MINUS, pH PLUS, Tac PLUS	Equilibrar los parámetros del agua Balance water parameters Équilibrer les paramètres de l'eau Equilibrare i parametri dell'acqua
-----------------------------------	--------------------------------------------------------------------------------------------------------------------------------------------

MANTENIMIENTO · MAINTENANCE · ENTRETIEN · MANTENIMENTO

ClorLENT, BromLENT	Desinfectar permanentemente Continuous disinfection Désinfecter en continu Disinfezione permanente
-----------------------	-------------------------------------------------------------------------------------------------------------

ALGICIDA · ALGAECIDE · ALGICIDE · ANTIALGHE

AntiALG, AntiALG XTRA	Prevenir la aparición de algas y eliminar las algas existentes Prevent algae growth and remove the existing ones Prévenir l'apparition d'algues et éliminer les algues existantes Prevenire la comparsa di alghe ed eliminare le alghe esistenti
--------------------------	-----------------------------------------------------------------------------------------------------------------------------------------------------------------------------------------------------------------------------------------------------------

FLOCULANTE · FLOCCULANT · FLOCULANT · FLOCCULANTE

Floculant	Clarificar el agua y mejorar el rendimiento de la filtración Clarify the water and improve the filter's performance Clarifier l'eau et améliorer la performance du filtre Rendere limpida l'acqua e migliorare la resa della filtrazione
-----------	---------------------------------------------------------------------------------------------------------------------------------------------------------------------------------------------------------------------------------------------------

MULTIACCIÓN · MULTIACTION · MULTIACCIÓN · MULTIAZIONE

Comple 5, Total 5, Total 10	Cloro, antialgas y floculantes en una sola aplicación Chlorine, anti-algae and flocculant in a single application Chlore, anti-algues et floculant en une seule application Cloro, antialghe e flocculanti in un'unica applicazione
-----------------------------------	----------------------------------------------------------------------------------------------------------------------------------------------------------------------------------------------------------------------------------------------

3 Stop

Tratamiento de invierno Wintering

Traitement d'hivernage Trattamento per l'inverno

EQUILIBRIO · BALANCE · ÉQUILIBRE · EQUILIBRIO

pH MINUS, pH PLUS	Equilibrar los parámetros del agua Balance water parameters Équilibrer les paramètres de l'eau Equilibrare i parametri dell'acqua
----------------------	--------------------------------------------------------------------------------------------------------------------------------------------

DESINFECCIÓN · DISINFECTION · DÉSINFECTION · DISINFEZIONE

ClorCHOC, BromCHOC	Eliminar todos los gérmenes y contaminantes del agua Remove all germs and contaminants from the water Éliminer tous les germes et polluants de l'eau Eliminare tutti i germi e le sostanze inquinanti dall'acqua
-----------------------	---------------------------------------------------------------------------------------------------------------------------------------------------------------------------------------------------------------------------

INVERNAJE · WINTERING · HIVERNAGE · SVERNAMENTO

Winter, WinterFLOAT	Tratamiento completo durante el invierno Complete treatment during winter Traitement complet en période d'hivernage Trattamento invernale completo
------------------------	-------------------------------------------------------------------------------------------------------------------------------------------------------------

■ producto químico ■ chemicals

New! • ¡Novedad!
New single-dose format more comfortable
Nuevo formato en monodosis más cómodo



MINORADOR DE pH pH REDUCE
BAISSE LE pH RIDUTTORE pH

pH MINUS

MONODOSIS SINGLE-DOSE ECODOSES MONODOSI

 Ref. PPHME 650 g DIS 5 

 Ref. PPHM 650 g DIS 5 



INCREMENTADOR DE pH pH INCREASE
AUGMENTE LE pH INCREMENTATORE pH

pH PLUS

MONODOSIS SINGLE-DOSE ECODOSES MONODOSI

 Ref. PPHPE 750 g DIS 5 

 Ref. PPHP 750 g DIS 5 



CLORO CHOQUE SHOCK CHLORINE
CHLORE CHOC CLORO SHOCK

CLORCHOC

MONODOSIS SINGLE-DOSE ECODOSES MONODOSI

 Ref. PCLSCH 300 g DIS 5 

 Ref. PCLSCH 300 g DIS 5 



COMPLET 4 ACCIONES COMPLET 4 ACTIONS
COMPLET 4 AZIONI

CHLORE 4 ACTIONS

MONODOSIS SINGLE-DOSE ECODOSES MONODOSI

 Ref. PCLMULE 5x250 g DIS 6 

 Ref. PCLMUL 5x250 g DIS 6 

Nouveauté! • Nuovo!

Nouveau format en écodoses très facile à utiliser
Nuovo formato monodosi più confortevole



**ANTIALGAS ANTI ALGAE
ANTI-ALGUES ANTIALGHE**

ANTI - ALGUES

MONODOSIS SINGLE-DOSE ECODOSES MONODOSI

Ref. PALGE 8x20 g DIS 6 8 412081 303086

Ref. PALG 8x20 g DIS 6 8 412081 302997



**FLOCULANTE FLOCCULANT
FLOCCULANT FLOCCULANTE**

FLOCCULANT

MONODOSIS SINGLE-DOSE ECODOSES MONODOSI

Ref. PNATCLE 4x30 g DIS 8 8 412081 303093

Ref. PNATCL 4x30 g DIS 8 8 412081 303000



Antialgas + Floculante + Antical + Agua libre de aceites y espuma
Antialgae + Flocculant + Anti lime + Water free of oils and foam
Anti-algues + Flocculant + Anti-calcaire + Eau sans huile ni mousse
Antialghe + Flocculante + Anticalcare + Acqua priva di oli e schiuma

MULTIPROTECT

MONODOSIS SINGLE-DOSE ECODOSES MONODOSI

Ref. PCPMPE 8x35 g DIS 5 8 412081 303109

Ref. PCPMP 8x35 g DIS 5 8 412081 303017

Filtro de cartucho Cartridge filter Epurateur à cartouche Filtri a cartuccia

Ref. PCPMPCE 8x35 g DIS 5 8 412081 303116

Ref. PCPMPC 8x35 g DIS 5 8 412081 303024



**INVERNADOR WINTERISER
HIVERNAGE TRATTAMENTO PER L'INVERNO**

MONODOSIS SINGLE-DOSE ECODOSES MONODOSI

Ref. PWINTCE 350 g DIS 5 8 412081 303123

Ref. PWINTC 350 g DIS 5 8 412081 303031



■ producto químico ■ chemicals

PRODUCTO QUÍMICO SIN BÓRICO
BORIC FREE CHEMICALS
PRODUITS CHIMIQUES SANS ACIDE BORIQUE
PRODOTTO CHIMICO SENZA BORICO



SmartCare Technology



**Boric
Acid Free**



**Long
Lasting**



Cleaner

Producto más sano. Nuestro aditivo no es en ningún caso perjudicial para la salud.

Healthier product. Our additive is not harmful to health in any way.

Produit plus sain. Notre additif n'est pas nocif pour la santé.

Prodotto più sano. Il nostro additivo non è dannoso per la salute in alcun modo.

Más eficaz. Permite una disolución más lenta y homogénea de la pastilla.

More effective. It allows a slower and more homogeneous dissolution of the tablet.

Plus efficace. Cela permet une dissolution plus lente et plus homogène des pastilles.

Più efficace. Permette una dissoluzione più lenta e omogenea della compressa.

Más limpio. No deja ningún residuo: reduce el consumo de otros químicos y el de agua por limpiezas del filtro.

Cleaner. It does not leave any residue: it reduces the consumption of other chemicals and water.

Plus propre. Il ne laisse aucun résidu: il réduit la consommation d'autres produits chimiques et celle d'eau par le nettoyage du filtre.

Cleaner. Non lascia alcun residuo: riduce il consumo di altri prodotti chimici e quello dell'acqua mediante pulizia del filtro.

Mantenimiento | Maintenance | Entretien | Manutenzione

1 Start 2 Play 3 Stop



CLORO LENTO TRICHLORINE
CHLORE LENT CLORO LENTO

Para conseguir una higienización preventiva y continua del agua, es necesario mantener una tasa de cloración libre. Por ello, conviene efectuar una cloración permanente o "cloración lenta".

To have a preventive and continue sanitizing, it is necessary to keep a free chloration value. For this reason, people must do a permanent chloration or a "slow chloration".

Pour avoir une hygiénisation préventive et continue, il est nécessaire de maintenir un taux de chloration libre. Pour cette raison, il faut effectuer une chloration permanente ou «chloration lente».

Per ottenere una igienizzazione preventiva e continua dell'acqua, è necessario mantenere un valore di cloro "libero". Per questo è bene effettuare una clorazione continua o una "clorazione lenta".

CLORLENT

TABLETAS 250g 250g TABLETS GALETS 250g PASTIGLIE 250g



Multiacción | Multi-action | Multiaction | Multiazione

1 Start 2 Play 3 Stop



COMPLET 4 ACCIONES COMPLET 4 ACTIONS
COMPLET 4 ACCIONES COMPLET 4 AZIONI

Cloro + Antialgas + Estabilizante + Floculante
Chlorine + Antialgae + Stabiliser + Flocculant
Chlore + Anti-algues + Stabilisant + Flocculant
Cloro + Antialghe + Stabilizzante + Flocculante

COMPLET 4 ACTIONS

TABLETAS 250g 250g TABLETS GALETS 250g PASTIGLIE 250g



TOTAL 5 ACCIONES TOTAL 5 ACTIONS
TOTAL 5 ACCIONES TOTAL 5 AZIONI

Cloro + Antialgas + Estabilizante + Floculante + Antical
Chlorine + Antialgae + Stabiliser + Flocculant + Anti lime
Chlore + Anti-algues + Stabilisant + Flocculant + Anti-calcaire
Cloro + Antialghe + Stabilizzante + Flocculante + Anticalcare

TOTAL 5 ACTIONS

TABLETAS 250g 250g TABLETS GALETS 250g PASTIGLIE 250g



■ producto químico ■ chemicals

Cálculo de volumen de agua

Para un correcto suministro del producto químico, es importante calcular el volumen de agua de la piscina.

Calculate the pool water volume

It is important to calculate the pool water volume to do a correct chemical treatment.

Calcul du volume d'eau

Pour un bon dosage du produit chimique, il est nécessaire de calculer le volume d'eau de la piscine.

Calcolo del volume d'acqua

Per un corretto dosaggio del prodotto chimico è importante calcolare il volume d'acqua di una piscina.



V = LxIxP

V = DxDxPx0,785

V = LxIxPx0,785

V = LxIxPx0,85

V	Volumen en m ³	Volume in m ³	Volume en m ³	Volume in m ³
L	Longitud en m	Length in m	Longueur en m	Lunghezza in m
I	Anchura en m	Width in m	Largeur en m	Larghezza in m
D	Diámetro en m	Diameter in m	Diamètre en m	Diametro in m
P	Profundidad en m	Depth in m	Profondeur en m	Profondità media in m

Ejemplo Example Exemple Esempio

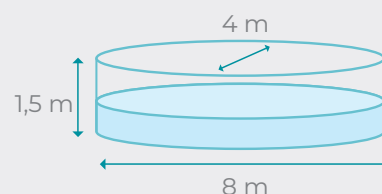

$$1,5 \text{ m} \times 8 \times 4 \times 0,785 = \mathbf{37,68 \text{ m}^3}$$

LEYENDA LEGEND LÉGENDE LEGENDA

	500 g				1 L
	1 Kg		10 Kg		
	1 Kg /1,5 Kg		1 L		1 kg
	3 kg		3 L		1 L / 0,5 L
	5 Kg		5 L		1/2 BOX PALET
	5 Kg		10/20 L		

Equilibrio | Balance | Équilibre | Equilibrio

1 Start 2 Play 3 Stop

El pH indica la acidez o la basicidad del agua. En una piscina debe mantenerse ajustado entre los valores 7.2 y 7.6, ya que además de conservar las instalaciones en óptimas condiciones, es el ideal para la piel y los ojos de los bañistas.
 pH shows if water is acid or basic. Pool water pH must be between 7.2 and 7.6, because it helps to conserve the equipment in good conditions and it is ideal for swimmer eyes and skin.
 Le pH indique l'acidité ou la basicité de l'eau. L'eau de la piscine doit se maintenir entre les taux 7.2 et 7.6, car cela aide non seulement à mieux conserver les installations, mais c'est également le taux idéal pour protéger la peau et les yeux des baigneurs.
 Il pH indica la acidità e la basicità dell'acqua. In una piscina il valore di riferimento deve essere sempre tra 7.2 e 7.6, dal momento che, oltre a favorire il trattamento chimico che viene effettuato, è il valore ideale affinché la pelle e gli occhi dei bagnanti non si irritino.



MINORADOR DE pH pH REDUCE
 BAISSÉ LE pH RIDUTTORE pH

pH MINUS

GRANULADO GRANULES GRANULÉS GRANULATO

Ref. 76019 1,5 Kg pack 20 8 427370 760198

Ref. 76002 5 Kg pack 4 8 427370 760020

Ref. 76095 20 l pack 1 8 412081 313948

Minorador de pH: para bajar y estabilizar el pH
 pH reduce: to lower and stabilize pH
 Baisse le pH: pour baisser et stabiliser le pH
 Per abbassare e stabilizzare il pH



INCREMENTADOR DE pH pH INCREASE
 AUGMENTE LE pH INCREMENTATORE pH

pH PLUS

GRANULADO GRANULES GRANULÉS GRANULATO

Ref. 76018 1 Kg pack 20 8 427370 760181

Ref. 76001 5 Kg pack 4 8 427370 760013

Incrementador de pH: para aumentar y estabilizar el pH
 pH increase: to increase and stabilize pH
 Augmente le pH: pour augmenter et stabiliser le pH
 Per aumentare e stabilizzare il pH

Equilibrio | Balance | Équilibre | Equilibrio

1 Start 2 Play 3 Stop



TAC PLUS

GRANULADO GRANULES GRANULÉS GRANULATO

Ref. 76081 5 Kg pack 4 8 427370 760815

Incrementador de alcalinidad
 Alkalinity increase
 Augmente l'alcalinité
 Elevatore di alcalinità

7.2

7.6

pH OK

use pH+

use pH-

■ producto químico ■ chemicals

Desinfección | Disinfection | Désinfection | Disinfezione

1 Start 2 Play 3 Stop

CLOCHOC

El Cloro Choque permite destruir rápida y eficazmente todos los organismos, hongos y bacterias. Conviene realizar una cloración de choque: Al inicio de la temporada de baño / Después de condiciones climáticas extremas / En caso de uso intensivo de la piscina.

It eliminates quickly all the organisms and bacteria. It is necessary to do a Shock chlorination: At the beginning of the swim season / After bad weather conditions / High use level.

Le Chlore Choc permet de détruire rapidement et efficacement tous les organismes, champignons et bactéries. Il convient d'effectuer une chloration choc: Au début de la saison de baignade / Après des conditions climatiques extrêmes / En cas d'usage intensif de la piscine.

Permette di eliminare rapidamente ed efficacemente tutti gli organismi, funghi e batteri. È utile usare questo tipo di prodotto: All'inizio della stagione / Dopo condizioni climatiche estreme / In caso di un uso intensivo della piscina.

PASTILLAS 20g 20g TABLETS PASTILLES 20g PASTIGLIE 20g

 Ref. **76074** 1 Kg pack 20 

 **76100** 8412081315386

 Ref. **76075** 3 Kg pack 4 

 **76059** 8412081315409

 Ref. **76076** 5 Kg pack 4 

 **76099** 8412081315393

GRANULADO GRANULES GRANULÉS GRANULATO

 Ref. **76021** 1 Kg pack 20 

 **76066** 8412081315317

 Ref. **76062** 1 Kg pack 210 



 **76079** 8412081315300

 Ref. **76069** 3 Kg pack 4 

 **76096** 8412081315324

 Ref. **76004** 5 Kg pack 4 

 **76078** 8412081315294

 Ref. **76064** 5 Kg pack 60 

 **76097** 8412081315331



Mantenimiento | Maintenance | Entretien | Manutenzione

1 Start 2 Play 3 Stop

CLORENT

Para conseguir una higienización preventiva y continua del agua, es necesario mantener una tasa de cloración libre. Por ello, conviene efectuar una cloración permanente o "cloración lenta".

To have a preventive and continue sanitizing, it is necessary to keep a free chlorination value. For this reason, people must do a permanent chlorination or a "slow chlorination".

Pour avoir une hygiénisation préventive et continue, il est nécessaire de maintenir un taux de chloration libre. Pour cette raison, il faut effectuer une chloration permanente ou «chloration lente».

Per ottenere una igienizzazione preventiva e continua dell'acqua, è necessario mantenere un valore di cloro "libero". Per questo è bene effettuare una clorazione continua o una "clorazione lenta".

TABLETAS 250g 250g TABLETS GALETS 250g PASTIGLIE 250g

 Ref. **76022** 1 Kg pack 18 

 Ref. **76005** 5 Kg pack 4 

GRANULADO GRANULES GRANULÉS GRANULATO

 Ref. **76023** 1 Kg pack 20 

Desinfección | Disinfection | Désinfection | Disinfezione

1 Start 2 Play 3 Stop



BROMO BROMINE BROME BROMO

Diferencias respecto al cloro: menos olor, no daña la piel ni el cabello. Más eficacia en las aguas calientes y/o calcáreas.

Differences compared to chlorine: less smell, does not dry out skin and hair. More efficient in hot and/or calcareous water.

Différences par rapport au chlore: moins d'odeur, ne dessèche pas la peau ni les cheveux. Plus efficace dans les eaux chaudes et/ou calcaires.

Differenze rispetto al cloro: meno odore, non danneggia la pelle né i capelli. Più efficace con l'acqua molto calda e/o calcarea.

BROM'LENT

PASTILLAS 20g 20g TABLETS PASTILLES 20g PASTIGLIE 20g

 Ref. 76025 1 Kg pack 20 

 Ref. 76024 5 Kg pack 4 

BROM CHOC

GRANULADO GRANULES GRANULÉS GRANULATO

 Ref. 76026 5 Kg pack 4 

 Referencia no disponible para España

BROM MULTIACTIONS

PASTILLAS 20g 20g TABLETS PASTILLES 20g PASTIGLIE 20g

 Ref. 76027 5 Kg pack 4 

Bromo multi-Acciones
Bromine multi-Actions
Brome multi-Actions
Bromo multi funzioni

**OXÍGENO ACTIVO ACTIVE OXYGEN
OXYGÈNE ACTIF OSSIGENO ATTIVO**

Ofrece muchas ventajas, ya que proporciona una desinfección muy eficaz y a diferencia del cloro, no provoca irritaciones oculares ni desprende olores desagradables. Producto que necesita de un dosificador.

This product offers a lot of advantages. It disinfects pool water and contrary to chlorine, it does not cause eye irritation neither and bad smells. This product needs a dispenser.

Ce produit offre de nombreux avantages par rapport au chlore, car il ne provoque aucune irritation oculaire, ôte les mauvaises odeurs et désinfecte très efficacement. Un doseur est nécessaire pour utiliser ce produit.

Offre molti vantaggi, dal momento che sviluppa una igienizzazione molto efficace e, a differenza del cloro, non irrita gli occhi e non ha un odore sgradevole. È un prodotto che necessita del dosatore.

ACTI OXY

LÍQUIDO LIQUID LIQUIDE LIQUIDO

 Ref. 76028 5 L pack 4 

 Ref. 76098 5 L pack 4 

PASTILLAS 20g 20g TABLETS PASTILLES 20g PASTIGLIE 20g

 Ref. 76029 1,2 Kg pack 20 

 Uniquement pour la france

■ producto químico ■ chemicals

Multiacción | Multi-action | Multiaction | Multiazione

1 Start **2** Play **3** Stop



Se trata de un producto revolucionario, ya que gracias a su fórmula innovadora permite en una sola aplicación, eliminar las bacterias, virus y microorganismos en general, evitar el desarrollo de algas, al mismo tiempo que mantiene transparente y cristalina el agua.
 Revolution product: Thanks to its new formula, allows in a single application eliminate bacteria, virus and micro organisms, avoid algae and have clear and crystalline water.

Il s'agit d'un produit révolutionnaire. Grâce à sa formule innovatrice, il permet avec une seule application, d'éliminer les bactéries, virus et micro-organismes en général, d'éviter l'apparition d'algues et de conserver une eau transparente et cristalline.
 Si tratta di un prodotto rivoluzionario proprio perché, grazie alla sua formula innovatrice, permette, in una sola applicazione, di eliminare i batteri, virus e tutti i microrganismi evitando il proliferare di alghe, mantenendo allo stesso tempo l'acqua trasparente e cristallina.

Cloro + Antialgas + Estabilizante + Floculante
 Chlorine + Antialgae + Stabiliser + Flocculant
 Chlore + Anti-algues + Stabilisant + Flocculant
 Cloro + Antialghe + Stabilizzante + Flocculante

COMPLET 4 ACTIONS



TABLETAS 250g 250g TABLETS GALETS 250g PASTIGLIE 250g

 Ref. **76007** 1 Kg pack 18 

 Ref. **76063** 1 Kg pack 252 

 Ref. **76067** 3 Kg pack 4 



 Ref. **76006** 5 Kg pack 4 

 Ref. **76055** 5 Kg pack 60 



 Ref. **76031** 10 Kg pack 2 

PASTILLAS 20g 20g TABLETS PASTILLES 20g PASTIGLIE 20g

 Ref. **76032** 1 Kg pack 20 

 Ref. **76033** 5 Kg pack 4 

GRANULADO GRANULES GRANULÉS GRANULATO



 Ref. **76034** 5 Kg pack 4 



COMPLET 4 ACTIONS- SPECIAL LINER

TABLETAS 250g 250g TABLETS GALETS 250g PASTIGLIE 250g

 Ref. **76039** 1 Kg pack 18 

 Ref. **76012** 5 Kg pack 4 

Sin sulfato de cobre
 Without copper sulphate.
 Sans sulfate de cuivre
 Senza solfato di rame



Cloro + Antialgas + Estabilizante + Flocculante + Antical
 Chlorine + Antialgae + Stabiliser + Flocculant + Anti lime
 Chlore + Anti-algues + Stabilisant + Flocculant + Anti-calcaire
 Cloro + Antialghe + Stabilizzante + Flocculante +
 Anticalcare

TOTAL 5 ACTIONS

TABLETAS 250g 250g TABLETS GALETS 250g PASTIGLIE 250g

 Ref. **76082** 1 Kg pack 18 

 Ref. **76068** 3 Kg pack 4 

 Ref. **76036** 5 Kg pack 4 

 Ref. **76037** 10 Kg pack 2 

**BOYA MULTIFUNCIÓN
 MULTIACTION FLOAT
 BOUÉE MULTI-ACTION
 TRATTAMENTO GALLEGGIANTE MULTI
 FUNZIONE**

HIVER FLOAT

PASTILLAS TABLETS PASTILLES PASTIGLIE



 Ref. **76085** 1,75 Kg pack 8 

Desinfectante + Bactericida + Flocculante +
 Coagulante + Algicida + Algistático + Regulador de
 pH + Estabilizante de cloro + Anticalcáreo + Virucida
 + Fungicida
 Disinfectant+ Germicide + Flocculent + Coagulant
 + Algicide + Algistatic + pH regulator + Chlorine
 stabilizer + Anti-Limescale Agent + Virucide+
 Fungicide
 Désinfectant + Bactéricide + Flocculant + Coagulant
 + Algicide + Algistatique + Régulateur de pH +
 Stabilisant de chlore + Anticalcaire + Virucide +
 Fongicide
 Disinfectante + Battericida + Flocculante +
 Coagulante + Alghicida + Alghistatico + Regolatore
 di pH + Stabilizzatore del cloro + Anticalcare +
 Virucida + Funghicida

TOTAL 10 ACTIONS

TABLETAS 250g 250g TABLETS GALETS 250g PASTIGLIE 250g

 Ref. **76065** 1 Kg pack 18 



 Ref. **76038** 5 Kg pack 4 

Cloro + Flocculante + Coagulante + Anti alghe +
 Alghestatico + Regolatore di pH + Stabilizzatore +
 Anticalcare

TOTAL 8 ACTIONS

PASTIGLIE 250g

 Ref. **76060** 1 Kg pack 18 

 Ref. **76061** 5 Kg pack 4 

 Solo per l'Italia

■ producto químico ■ chemicals

Multiacción | Multi-action | Multiaction | Multiazione

1 Start

2 Play

3 Stop



Las algas son organismos vegetales unicelulares que pueden desarrollarse y multiplicarse rápidamente en el agua, sobre todo cuando su temperatura es templada. Algae are vegetal unicellular organisms that can quickly develop and multiply themselves in the water, specially when the temperature of the water is warm.

Les algues sont des organismes végétaux unicellulaires qui peuvent apparaître et se multiplier très rapidement dans l'eau, surtout quand la température de l'eau est tempérée.

Le alghe sono organismi vegetali unicellulari che possono svilupparsi e moltiplicarsi soprattutto quando la temperatura dell'acqua è abbastanza calda.

ANTIALG XTRA

LÍQUIDO LIQUID LIQUIDE LIQUIDO

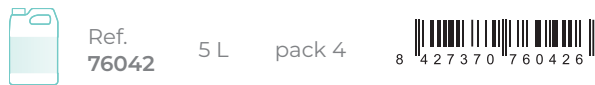

3 acciones. Extra: para eliminar todas las algas.
3 actions. Extra: to eliminate the algae.
3 actions. Extra: pour éliminer la totalité des algues.
3 azioni. Extra. Per eliminare tutti i tipi di alghe.

ANTIALG

LÍQUIDO LIQUID LIQUIDE LIQUIDO

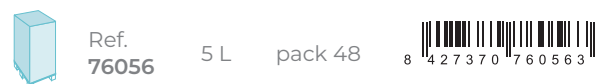
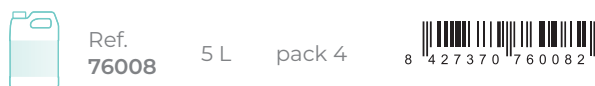
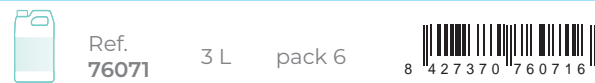

Para prevenir la aparición de algas.
To prevent the appearance of algae
Pour prévenir l'apparition d'algues.
Per prevenire la comparsa delle alghe.



ANTIALG COMPACT XTRA

LÍQUIDO LIQUID LIQUIDE LIQUIDO

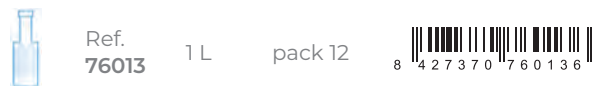

ANTIALG COMPACT

LÍQUIDO LIQUID LIQUIDE LIQUIDO

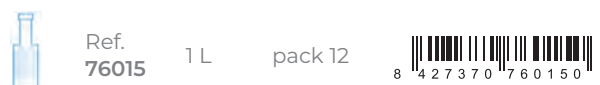

■ produits d'entretien ■ prodotti chimici

La floculación permite obtener un agua cristalina. Existen dos tipos de floculación: la que se realiza dentro del filtro y la floculación dentro del vaso. La primera permite aumentar la fineza de filtración y eliminar de esta manera las partículas más finas. Esta se efectúa gracias a los cartuchos floculantes (incompatibles con filtros de cartucho) colocados en el cesto del skimmer. La segunda permite agrupar entre ellas las impurezas que no pueden ser filtradas individualmente y que son el origen de un agua turbia. Esta operación se efectúa con el floculante líquido.

Flocculation allows to obtain a crystalline water. There are two kind of flocculation: inside the filter and in the pool. With the first one we increase the fineness of filtration in order to eliminate smaller particles. For this process we introduce flocculants cartridges (incompatible with cartridge filters) in the skimmer basket. The second one helps us to group all the impurities that are the beginning of brown water thanks to liquid flocculant.

La floculation permet d'obtenir une eau cristalline. Il y a deux types de floculation: celle qui se fait dans le filtre et la floculation dans le bassin. La première permet d'augmenter la finesse de filtration et d'éliminer de cette façon les particules les plus fines. Elle s'effectue grâce aux cartouches floculantes (incompatibles avec les filtres à cartouche) qui sont placées dans le panier du skimmer. La deuxième permet de regrouper entre elles les impuretés qui ne peuvent pas être filtrées et qui sont à l'origine des eaux troubles. Cette opération se fait avec le floculant liquide.

La flocculazione permette di ottenere un'acqua cristallina. Esistono due tipi di flocculazione: quella che si realizza all'interno del filtro e quella diluendo il prodotto in un contenitore. La prima permette di migliorare la filtrazione ed eliminare le particelle più fini e si effettua grazie alle cartucce flocculanti (incompatibili con i filtri a cartuccia) poste dentro il cesto dello skimmer. La seconda permette di raggruppare tra loro le impurità che non possono essere filtrate individualmente e che sono la causa dell'acqua torbida. Questo procedimento si effettua con il floculante liquido.

Floculante | Flocculant | Floculant | Flocculante

1 Start 2 Play 3 Stop



CARTUCHOS CARTRIDGES CARTOUCHES CARTUCCIA 125g

Ref. 76044 1 Kg pack 14 8 427370 760440

Para mejorar la calidad de filtración (filtros de arena únicamente). Producto de mantenimiento.

To increase filtration quality (sand filters only).

Product Maintenance.

Pour améliorer la qualité de filtration (filtres à sable uniquement).

Produit de maintenance.

Per migliorare la qualità della filtrazione (solo per filtri a sabbia).

Prodotto di mantenimento.



MONODOSIS PODS MONODOSE MONODOSI 90g

Ref. UFG90 90g DIS 36 8 412081 258126

Ultraflock: Gel floculante
Ultraflock: Flocculant Gel
Ultraflock: Floculant en gel monodose
Ultraflock: flocculante gel.

Floculante | Flocculant | Floculant | Flocculante

1 Start 2 Play 3 Stop



FLOCCULANT

LÍQUIDO LIQUID LIQUIDE LIQUIDO

Ref. 76011 1 L pack 12 8 427370 760112

Ref. 76073 3 L pack 6 8 427370 760730

Ref. 76010 5 L pack 4 8 427370 760105

Para clarificar el agua y eliminar las materias en suspensión.

Recupera el agua turbia.

To clarify water and eliminate substances in suspension.

Retrieve the cloudy water.

Pour clarifier l'eau et éliminer les matières en suspension.

Récupère l'eau trouble.

Rende acqua cristallina ed elimina le particelle in superficie.

Recupera l'acqua torbida.

■ producto químico ■ chemicals

Limpeza | Cleaning | Nettoyage | Pulizia

1 Start

2 Play

3 Stop



DESINCRUSTANTE DE SUPERFICIE
SURFACE DESCALER
DÉTARTRANT DE SURFACE
PULITORE SUPERFICI D'ACQUA

DETARTRANT SURFACE

LÍQUIDO LIQUID LIQUIDE LIQUIDO



Ref.
76046

1 L pack 12



Para eliminar incrustaciones de cal.
 To eliminate lime scales.
 Pour éliminer les incrustations calcaires.
 Per evitare la incrostazione del calcare.

LIMPIADOR DE BORDES
WATERLINE CLEANER
NETTOYANT LIGNE D'EAU
PULITORE SUPERFICI D'ACQUA

NETTOYANT LIGNE D'EAU

LÍQUIDO LIQUID LIQUIDE LIQUIDO



Ref.
76047

1 L pack 12



Para eliminar la suciedad de la línea de flotación.
 To eliminate the dirt on the waterline.
 Pour éliminer la saleté sur la ligne d'eau.
 Per eliminare particelle in superficie.



ANTICALCÁREO ANTI LIME
ANTI-CALCAIRE ANTICALCARE

ANTICALC

LÍQUIDO LIQUID LIQUIDE LIQUIDO



Ref.
76049

1 L pack 12



Ref.
76048

5 L pack 4



Para evitar la formación de cal.
 Secuestrante de metales (hierro, cobre...)
 To prevent lime formation.
 Metal Sequestering Agents (iron, copper...)
 Pour éviter la formation de calcare.
 Séquestrant de métaux (fer, cuivre, etc.)
 Evita la formazione del calcare.
 Sequestrante di metalli (ferro, rame)

Wintering | Invernaje | Hivernage | Svernamento

1 Start 2 Play 3 Stop

Le facilitará la puesta en marcha de la piscina después del invierno, evitando la formación de algas y de cal.

Realizar el proceso cuando la temperatura del agua de la piscina sea inferior a 15°C.

- 1) Limpiar la piscina.
- 2) Ajustar el pH entre 7,2 - 7,6
- 3) Realizar una cloración de choque
- 4) Dejar en funcionamiento el fi ltro hasta el día siguiente 5)

Realizar una limpieza del fi ltro

6) Añadir el invernador

It makes easier for you the start-up of the pool after winter, avoiding algae and lime formation.

Please carry out the following if the temperature of the water drops below 15°C.

- 1) Clean the swimming pool
- 2) Set the pH balance between 7.2 - 7.6
- 3) Carry out a chlorine crash course
- 4) Leave the fi lter running until the following day
- 5) Clean the fi lter
- 6) Add the winterizing agent

Les produits de traitement de l'eau vous facilitent la remise en route de la piscine après la période d'hivernage, en évitant la formation d'algues et de calcaire. Procéder au traitement lorsque la température de l'eau de la piscine est inférieure à 15°C.

- 1) Nettoyer la piscine
- 2) Ajuster le pH entre 7,2 - 7,6
- 3) Réaliser une chloration de choc
- 4) Laisser fonctionner le filtre jusqu'au lendemain
- 5) Nettoyer le filtre
- 6) Ajouter l'hivernant

Renderà piú semplice l'inizio della nuova Stagione, dopo l'inverno, evitando la formazione di alghe e calcare.

Realizzare la procedura quando la temperatura dell'acqua della piscina è inferiore a 15°C.

- 1) Pulire la piscina
- 2) Regolare il pH tra 7,2 e 7,6
- 3) Eff ettuate una clorazione d'urto
- 4) Lasciare in funzione il fi ltro fi no al giorno successivo
- 5) Eff ettuate una pulizia del fi ltro
- 6) Aggiungere lo svernante



INVERNADOR WINTERISER
HIVERNAGE TRATTAMENTO PER L'INVERNO

HIVERNAGE

LÍQUIDO LIQUID LIQUIDE LIQUIDO



Ref. 76050

1 L

pack 12



Ref. 76051

5 L

pack 4



INVERNADOR CON BOYA MULTIFUNCIÓN
MULTIACTION FLOAT WINTERISER
BOUÉE HIVERNAGE MULTI-ACTION
TRATTAMENTO PER L'INVERNO
GALLEGGIANTE MULTI FUNZIONE

HIVER FLOAT

PASTILLAS TABLETS PASTILLES PASTIGLIE



Ref. 76080

1,75 Kg

pack 8



■ producto químico ■ chemicals

GAMA QUÍMICO ECO ECO CHEMICALS PRODUITS D'ENTRETIEN ECO PRODOTTI CHIMICI ECO

REGULADORES DE PH • PH REGULATORS • RÉGULATEURS DE PH • CORRETTORI DI PH



Minorador de pH granulado • Granules pH reduce • pH moins sous forme de granulés • Riduttore pH granulato

5 Kg  REF. 90001 PACK 4 

Minorador de pH liquido • Liquid pH reduce • pH moins liquide • Riduttore pH liquido

5l  REF. 90003 PACK 4 

25l  REF. 90008 PACK 1 



Incrementador de pH granulado • Granules pH increase • pH plus sous forme de granulés • Incrementatore pH granulato

4,5 Kg  REF. 90005 PACK 4 

Incrementador de pH granulado • Granules pH increase • pH plus sous forme de granulés • Incrementatore pH granulato

1l  REF. 90048 PACK 12 

5l  REF. 90006 PACK 4 



HIGIENIZANTES • SANITIZINGS • HYGIÉNISATION • IGIENIZZANTI

Cloro lento tabletas 250 gr • Slow chlorine 250 gr tablets • Chlore lent galets 250 gr • Cloro Lento pastiglie 250g

1 Kg  REF. 90055 PACK 18 

5 Kg  REF. 90010 PACK 4 

PALETTE 5 Kg   REF. 90058 PAL 120 

10 Kg  REF. 90012 PACK 2 

Cloro choque pastillas 20 gr • Shock chlorine 20 gr tablets • Chlore choc pastilles 20 gr • Cloro shock pastiglie 20g

1 Kg  REF. 90078 PACK 20 

5 Kg  REF. 90073 PACK 4 

 REF. 90084 8412081315430

BOX 5 Kg   REF. 90203 BOX 60 

 REF. 90082 8412081315416

PALETTE 5 Kg   REF. 90072 PAL 120 

10 Kg  REF. 90074 PACK 2 

 REF. 90083 8412081315423



■ produits d'entretien ■ prodotti chimici

Cloro choque granulado • Granules shock chlorine • Chlore choc sous forme de granulés • Cloro shock granulado



1 Kg  REF. 90050 PACK 20  8 427370 900501

5 Kg  REF. 90020 PACK 4  8 427370 900204



REF. 90081 8412081315355

PALETTE 5 Kg   REF. 90060 PAL 120  8 427370 900600



10 Kg  REF. 90021 PACK 2  8 427370 900211



REF. 90079 8412081315348

Cloro 4 acciones tabletas 250 gr • Chlorine 4 actions 250 gr tablets • Chlore 4 actions galets 250 gr • Cloro 4 azioni pastiglie 250g

1 Kg  REF. 90052 PACK 18  8 427370 900525

5 Kg  REF. 90025 PACK 4  8 427370 900259



BOX 5 Kg   REF. 90200 BOX 60  8 427370 902000

PALETTE 5 Kg   REF. 90057 PAL 120  8 427370 900570

10 Kg  REF. 90027 PACK 2  8 427370 900273



25 Kg  REF. 90028 PACK 1  8 427370 900280

Cloro 5 acciones tabletas 250 gr • Chlorine 5 actions 250 gr tablets • Chlore 5 actions galets 250 gr • Cloro 5 azioni pastiglie 250g

5 Kg  REF. 90051 PACK 4  8 427370 900518

TRATAMIENTO ANTIALGAS • ANTI-ALGAE TREATMENT • TRAITMENT ANTI-ALGUES • TRATTAMENTO ANTIALGHE

Antialgas liquido concentrado • Liquid anti-algae • Anti-algues liquide • Antialghe liquido concentrato



1l  REF. 90053 PACK 12  8 427370 900532

5l  REF. 90030 PACK 4  8 427370 900303

BOX 5l   REF. 90202 BOX 48  8 427370 902024

10l  REF. 90032 PACK 1  8 427370 900327

FLOCULANTE • FLOCCULANT • FLOCULANT • FLOCCULANTE

Floculante liquido • Liquid flocculant • Floculant liquide • Floculante liquido



1l  REF. 90054 PACK 12  8 427370 900549

5l  REF. 90042 PACK 4  8 427370 900426

Floculante cartucho • Cartridge flocculant • Floculant cartouche • Floculante a cartuccia

1Kg  REF. 90046 PACK 14  8 427370 900464

INVERNADOR • WINTERISER • HIVERNAGE • PRODOTTI CHIMICI PER L'INVERNO

Invernador liquido • Liquid winteriser • Hivernage liquide • Trattamento per l'inverno liquido

5l  REF. 90035 PACK 4  8 427370 900358

■ producto químico ■ chemicals

SaniPLUS

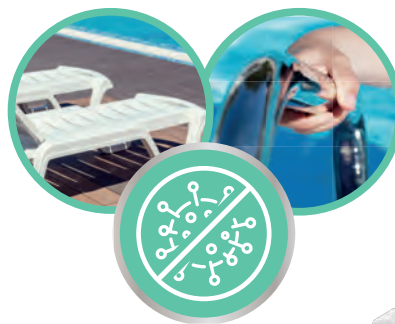

REF. 76093

DIS PACK 9



Higienizante multi-superficies.
1l en formato spray para
superficies pequeñas y un fácil
uso.

Multi-surface sanitizer.
1l in spray format for small
surfaces and easy use.

Désinfectant multi-surfaces.
1l en format spray pour petites
surfaces et utilisation facile.

Igienizzante multi-superfici.
1l formato spray per piccole
superfici e di semplice utilizzo.



Only for France and Portugal · Uniquement pour la france et le portugal

REF. 76094

DIS PACK 9



Higienizante multi-superficies.
5l para grandes superficies.

Multi-surface sanitizer.
5l for large surfaces.

Désinfectant multi-surfaces.
5l pour les grandes surfaces.

Igienizzante multi-superfici.
5l per grandi superfici.



Only for France and Portugal · Uniquement pour la france et le portugal

REF. 76077

DIS PACK 12



Stop Aguas Verdes
5 litros.

Stop Green Waters
5 litres.

Stop Eaux Vertes
5 litres.

Stop Acque Verdi
5 litri.



REF. 90175

DIS PACK 24



Repulsivo Anti Insectos a
base de aceites esenciales
100% naturales. Dosifi cador
de 3 pastillas de 30g.

Anti Insect repellent using
100% natural essential oils.
30 g 3 tablet dosifier.

Répulsif Anti Insectes à base
d'huiles essentielles 100%
naturelles.
Doseur de 3 pastilles de 30g.

Repellente anti-insetti a
base di oli essenziali 100%
naturali. Dosatore di 3
pastiglie da 30g.





REF. 90178

DIS PACK 12



3 760120 430275

Repulsivo Anti Insectos a base de aceites esenciales 100% naturales. Caja de 6 pastillas de 30g.

Anti Insect repellent using 100% natural essential oils. 30g 6 tablet box.

Répulsif Anti Insectes à base d'huiles essentielles 100% naturelles. Boite carton de 6 pastilles de 30g.

Repellente anti-insetti a base di oli essenziali 100% naturali. Confezione di 6 pastiglie da 30g.



REF. 90147

DIS PACK 12



3 760120 430282

Stop Aguas Verdes
Recupera las aguas verdes gracias a una nueva generación de polimeros hidrosolubles. Caja de 6 pastillas de 20g.

Stop Green Waters
Get back the green waters of your pool thanks to a new generation of water soluble polymers. 20g 6 tablet box.

Stop Eaux Vertes
Il récupère les eaux vertes grâce à une nouvelle génération de polymères hydrosolubles. Boite carton de 6 pastilles de 20g.

Stop Acque Verdi
Recupera le acque verdi grazie ad una nuova generazione di polimeri idrosolubili. Confezione di 6 pastiglie da 20g.



REF. 90143

DIS PACK 12



3 760120 430299

Stop Aguas Turbias
Recupera las aguas turbias, y consigue un agua limpia y cristalina. Caja de 6 pastillas de 30g.

Stop Cloudy Waters
Get back the cloudy waters to obtain a cristal-clear water. 30g 6 tablet box.

Stop Eaux Troubles
Traite les eaux troubles, et rend l'eau propre et cristalline. Boite carton de 6 pastilles de 30g.

Stop Acque Torbide
Recupera le acque torbide, la sua efficacia permette di avere un'acqua limpida e cristallina. Confezione di 6 pastiglie da 30g.



REF. SATC6

DIS PACK 12



3 760120 430343

Stop Aguas Turbias
Recupera las aguas turbias, y consigue un agua limpia y cristalina. Para piscinas con filtro de cartucho. Caja de 6 pastillas de 17g.

Stop Cloudy Waters
Get back the cloudy waters to obtain a cristal-clear water. For pools with cartridge filter. 17g 6 tablet box.

Stop Eaux Troubles
Traite les eaux troubles, et rend l'eau propre et cristalline. Convient pour les piscines avec filtration à cartouche. Boite carton de 6 pastilles de 17g.

Stop Acque Torbide
Recupera le acque torbide, la sua efficacia permette di avere un'acqua limpida e cristallina. Per le piscine con filtro a cartuccia. Confezione di 6 pastiglie da 17g.

■ producto químico ■ chemicals

POOLP'OS POOLP'OS POOLP'OS POOLP'OS

- Solución de tratamiento "Todo en Uno". Ideal piscinas elevadas con o sin filtración. Tratamiento mensual.
- 4 Acciones: Higienizante, Antibacterias, Antialgas y Floculante
- No hay manipulación directa de producto químico. No perjudica la filtración gracias a su forma optimizada que deja el circuito de agua intacto. El POOLP'O sube a la superficie una vez acabado el producto químico, avisando de la necesidad de empezar un nuevo tratamiento.

- Solution de traitement "Tout en Un". Idéal pour les piscines hors-sol avec ou sans filtration. Nécessite un traitement mensuel.
- 4 Actions: Hygiénisant, Anti-bactéries, Anti-algues, Floculant.
- Pas de manipulation directe de produits chimiques. N'endommage pas le système de filtration grâce à sa forme optimisée qui laisse le circuit de l'eau intact. Ne gêne pas le volet du skimmer de par sa petite taille. Le POOLP'O remonte à la surface une fois que le produit chimique est consommé, prévenant ainsi de la nécessité de commencer un nouveau traitement.

- Treatment solution "All in One" for Above ground Pools with and without filtration. Monthly treatment.
- 4 actions: Sanitizing, Anti-bacteria, Anti-algae and Flocculant.
- No direct handling of chemical product. It does not obstruct filtration thanks to its form optimized - which leaves the circuit of water intact. It goes up once product finished, so you know you should start a new treatment.

- Soluzione "Tutto in uno". Adatto per piscine fuori terra con o senza filtrazione. Trattamento mensile
- 4 azioni: Igienizzanti, Anti- batteri, Antialghe e Floculante
- Non c'è contatto diretto con il prodotto chimico. Non danneggia la filtrazione grazie alla sua forma che lascia libero il circuito dell'acqua. El Poolp'o sale in superficie una volta terminato il prodotto chimico, avvisando della necessità di dover iniziare un nuovo trattamento

REF. 08012 BX PACK 16 8 427370 080128

POOLP'O 0-10m³ (250g)
POOLP'O 0-10m³ (250g)

POOLP'O 0-10m³ (250g)
POOLP'O 0-10m³ (250g)

REF. 08112 DIS 18 8 427370 081125

Display POOLP'O 0-10m³
(250g) 18 unidades
POOLP'O 0-10 m³ (250g)
Display 18 unités

Display POOLP'O 0-10 m³
(250g) 18 units
Display POOLP'O 0-10 m³
(250g) 18 unità



REF. 08013A BX PACK 16 8 427370 080135

POOLP'O 10-20m³ (500g)
POOLP'O 10-20m³ (500g)

POOLP'O 10-20m³ (500g)
POOLP'O 10-20m³ (500g)

REF. 08113 DIS 18 8 427370 081132

Display POOLP'O 10-
20m³ (500g) 18 unidades
POOLP'O 10-20m³ (500g)
Display 18 unités

Display POOLP'O 10-20m³
(500g) 18 units
Display POOLP'O 10-
20m³ (500g) 18 unità



REF. 08099A BX PACK 9 8 412081 250885

POOLP'O 10-30m³ (700g)
Dosificador flotante con
tratamiento químico.
Duración 3 semanas

POOLP'O 10-30m³ (700g)
Chemical treatment floating
dispenser.
3 weeks

POOLP'O 10-30m³ (700g)
Doseur flottant chimique
tout en un. Durée 3
semaines.

POOLP'O 10-30m³ (700g)
Dispenser galleggiante
con trattamento chimici. 3
settimane.



KITS PISCINA POOL KITS
KITS POUR PISCINE KIT PER PISCINE



REF. 76053

PACK 12



Kit para piscina de 0 a 5m³
Cloro lento pastillas de 5 g - 500 g + Dosificador + Pelota

Kit for 0-5m³ pool
Trichlorine 5g tablets - 500 g + Dispenser + Ball

Kit pour piscine de 0 à 5m³
Chlore lent pastilles de 5 g - 500 g + Doseur + Ballon

Kit per piscine da 0 a 5m³
Cloro lento pastiglie da 5g - 500g + dosatore + palla gonfiabile



REF. 76054

PACK 6



Kit para piscina de 5 a 15m³
Multifunciones pastillas 20g, 1kg + Dosificador + Termómetro + Analizador + Manguitos + Kit reparación liner

Kit for 5-15m³ pool
Multiactions 20g tablets, 1Kg + Dispenser + Thermometer + Test kit + Arm-bands + Liner repair kit

Kit pour piscine de 5 à 15m³
Multifonctions pastilles 20 g - 1kg + Doseur + Thermomètre + Trousse d'analyse + Brassards + Kit réparation liner

Kit per piscine da 5 a 15m³
4 azioni pastiglie da 20g, formato 1 Kg + Dosatore + termometro + Kit analisi + Bracciali + Kit riparazione liner



JUNIOR POOL

REF. KKP525

DIS PACK 18



Kit tratamiento químico para piscinas pequeñas sin filtración
5 bolsas de 25 ml
Kit traitement chimique pour petits bassins sans filtration
5 x 25 ml

Disinfection for small pools without filter
5 x 25 ml

Kit tratamiento per piscina piccola senza filtrazione
5 x 25 ml

■ producto químico ■ chemicals

KITS SPA SPA KITS

KITS POUR SPA KIT PER SPA

REF. 778776

PACK 12



Clean SPA 3 en 1
Pastillas de 20 gr - 1 Kg.

Clean SPA 3 in 1
20g tablets, 1Kg

Clean SPA 3 en 1
Pastilles 20g -1 kg

Clean SPA 3 in 1
Pastiglie da 20g, formato 1 Kg



Referencia no disponible para España

REF. KTSPA



REF. KTSPA



REF. KTSPA



Kit tratamiento para Spa
Spa desinfectante 30g
x4 + pH plus 20g x2 + pH
menos 30g x2

Kit traitement pour Spa
Sachets de désinfection 30g
x4 + pH plus 20g x2 +
pH moins 30g x2

**Kit with chemical treatment
for Spa**
Spa disinfect 30g x4 + pH
reduce 20g x2 + pH increase
30g x2

Kit trattamento per Spa
disinfezione Spa 30g x4 +
incrementatore pH 20g x2+
riduttore pH 30g x2



DIS PACK 12

REF. OXYS

DIS PACK 12



**TRATAMIENTO QUÍMICO
PARA SPA por oxígeno**
4 x oxígeno 20 g + 2 x
minorador de pH 30 g + 8 x
oxígeno activo 25 g + 4 x tiras
analíticas para oxígeno-pH

**TRAITEMENT CHIMIQUE
POUR SPA par oxygène**
4 x oxygène 20 g + 2 x
réducteur de pH 30 g + 8 x
oxygène actif 25 g + 4 x bandes
de test pour oxygène-pH

**SPA CHEMICAL TREATMENT
based on Oxygen**
4 x Oxygen 20 g + 2 x pH
minus 30 g + 8 x Oxygen
activator 25 g + 4 x Oxygen-
pH test strips

**TRATTAMENTO CHIMICO
SPA a base di Ossigeno**
4 x ossigeno 20 g + 2 x pH
minus 30 g + 8 x attivatore
di ossigeno 25 g + 4 x strisce
per test reattive all'ossigeno,
valore del pH



Référence exclusive pour la France

TESTERS DIGITALES DIGITAL TESTERS TESTEURS DIGITAL TESTER DIGITALE

REF. 40817

BL PACK 12



Recambio para el Aquacheck True Test: 25 tiras analíticas.

Recharge pour Aquacheck TruTest.: 25 languettes d'analyse

Aquacheck True Test refill: 25 test strips.

Ricarica di Aquacheck TruTest: 25 strisce di analisi.



REF. 38813

CS PACK 6



Aquacheck

Lector digital de tiras de análisis TruTest. Analiza los niveles de cloro/bromo libre, valor pH y alcalinidad total.

Aquacheck

Lecteur digital de bandelettes d'analyse TruTest. Résultats de Chlore/Brome libre, pH et Alcalinité totale.

Aquacheck

Digital Test Strip Reader. Tests for: Free Chlorine, pH, Total Alkalinity.

Aquacheck

Digital Test striscia lettore TruTest: cloro / bromo-libero, il pH e l'alcalinità totale.



TIRAS ANALÍTICAS ANALYSIS STRIPS LANGUETTES D'ANALYSE STRISCE DI ANALISI



REF. 40068

1/8 BL PACK 16



Análisis cloro + pH + alcalinidad (50 tiras).

Analyse chlore + pH + alcalinité (50 languettes).

Chlorine + pH + alkalinity analysis (50 strips).

Analisi cloro + pH + alcalinità (50 strisce).



REF. 40069

BX PACK 12



Analiza el nivel de sal en agua (16 tiras).

Analyse le niveau de sel dans l'eau (16 languettes).

Salt level in water analysis (16 strips).

Analizza il livello di sale nell'acqua (16 strisce).

ANALIZADORES TEST KITS
TROUSSES D'ANALYSE KIT TEST

REF. 40060

BL PACK 16



Analizador de cloro/bromo + pH (Oto/Phenol)

Trousse d'analyse de chlore/brome + pH (Oto/Phénol)

Test kit chlorine/bromine + pH (Oto/Phenol)

Kit analisi cloro/bromo + pH (oto/Phenol)



REF. 40061

BL PACK 12



Recambio Oto/Phenol
Recharge Oto/Phénol

Refi II Oto/Phenol
Ricambio Oto/Phenol



REF. 40062

DIS 1/8 CS PACK 24



Comparador cloro + pH - pastillas DPD1

Trousse d'analyse de chlore + pH - pastilles DPD1

Test kit chlorine + pH - DPD1 tablets

Kit analisi cloro + pH - pastiglie DPD1



REF. 40063

DIS 1/8 BL PACK 24



Recambio pastillas DPD1
Recharge pastilles DPD1

Refi II DPD1 tablets
Ricarica pastiglie DPD1





REF. 40066

DIS 1/8 CS PACK 24



Kit de análisis de oxígeno/
bromo + pH - pastillas DPD4
Trousse d'analyse d'oxygène/
brome + pH pastilles DPD4

Oxygen / bromine + pH test
kit - DPD4 tablets
Kit analisi ossigeno/bromo +
pH pastiglie DPD4



REF. 40067

DIS 1/8 BL PACK 24



Recambio pastillas DPD4
Recharge pastilles DPD4

Refi II DPD4 tablets
Ricarica pastiglie DPD4

material plv pos material matériels plv materiale pos



EXPOSITOR PISCINA CHAPA STEEL POOL EXHIBITOR
PRÉSENTOIR PISCINE ACIER EXPOSITORI PISCINE PARETI IN ACCIAIO



TOTEMS CARTÓN CARDBOARD TOTEMS
TOTEMS CARTON TOTEMS CARTONE



FOLLETOS LEAFLETS
DÉPLIANTS VOLANTINI

EXPOSITOR ROBOTS
ROBOTS EXHIBITOR
PRÉSENTOIR ROBOTS
EXPOSITORI ROBOTS



PISCINA DE EXPOSICIÓN
EXHIBITOR WOODEN POOL
PISCINE BOIS D'EXPOSITION
EXPOSITORI PISCINA IN LEGNO



Nos reservamos el derecho de cambiar total o parcialmente las características de nuestros artículos o el contenido de este documento sin previo aviso. Fotos e imágenes no contractuales.

We reserve the right to change all or part of the articles or contents of this document without prior notice. Photos and pictures are not contractual.

Nous nous réservons le droit de modifier totalement ou en partie les caractéristiques de nos articles ou le contenu de ce document sans préavis. Photos et images non contractuelles.

Ci riserviamo il diritto di cambiare totalmente o parzialmente le caratteristiche tecniche dei nostri prodotti ed il contenuto di questo documento senza nessun preavviso. La Fotografia o il disegno è solo a scopo illustrativo ed informativo.

Sede social Headquarters | **Siège social Sede centrale**

Manufacturas GRE S.A. | Aritz Bidea n° 57 | Belako Industrialdea | Apartado 69 | 48100 Mungia (Bizkaia) Spain

Tel. (34) 946 741 116 | Fax (34) 946 741 708 | gre@gre.es

Bureau Commercial France

Pintor Velazquez n°10 | 08213 Polinyà (Barcelona) | Spain

Tel : 09 73 32 57 01 | Fax : 09 73 32 57 00 | gre@grefrance.fr

Servicio Postventa After-sales service | **Service après-vente Servizio post-vendita**

WWW.SERVICE-GRE.COM

www.grepool.com



www.grepool.com

Manufacturas GRE S.A. | Aritz Bidea nº 57 | Belako Industrialdea | Apartado 69 | 48100 Mungia (Bizkaia) Spain
Tel. (34) 946 741 116 | Fax (34) 946 741 708 | gre@gre.es

FLUIDRA