



POOLS 2020



www.grepool.com



POOLS
2020

■ índice ■ index ■ sommaire ■ indice

INTRODUCCIÓN INTRODUCTION INTRODUCTION INTRODUZIONE		Pag. 04
PISCINAS ENTERRADAS IN-GROUND POOLS PISCINES ENTERRÉES PISCINE INTERRATA		Pag. 08
PISCINAS DE MADERA WOODEN POOL PISCINES BOIS PISCINA IN LEGNO		Pag. 16
PISCINAS DE COMPOSITE COMPOSITE POOLS PISCINES COMPOSITE PISCINA IN COMPOSITE		Pag. 38
PISCINAS HIBRIDAS HYBRIDS POOLS PISCINES HYBRIDE PISCINE IBRIDE		Pag. 44
PISCINAS DE ACERO STEEL WALL POOLS PISCINES PAROI ACIER PISCINA IN ACCIAIO		Pag. 48
COMPLEMENTOS COMPLEMENTES COMPLEMENTS COMPLEMENTI		Pag. 82
MATERIAL DE LIMPIEZA CLEANING MATERIAL MATÉRIEL DE NETTOYAGE MATERIALE DI PULIZIA		Pag. 136
PRODUCTO QUÍMICO CHEMICALS PRODUITS D'ENTRETIEN CHIMICI		Pag. 170

■ Novedades ■ New products
■ Nouveautés ■ Nuovo



Nuevos modelos de piscinas de madera
New models of wooden pools
Nouveaux modèles de piscines en bois
Nuovi modelli di piscine in legno

Nuevos modelos de piscinas de composite
New models of composite pools
Nouveaux modèles de piscines en composite
Nuovi modelli di piscine in composite

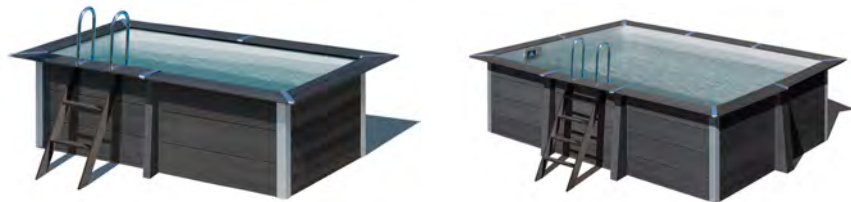

Cubiertas de invierno
Winter covers
Couvertures pour l'hiver
Copertura invernale
180g/m²



Enrollador básico piscinas elevadas
Basic cover roller for above-ground pools
Enrouleur pour piscines hors-sol
Avvolgitore per piscine fuoriterra



Cartucho
Cartidge
Cartouche
Cartuccia



Protector de suelo de piscina antideslizante
Non sleppery pool floor protector
Protecteur de sol de pisciner
Protezione per il fondo della piscina

Filtro independiente soplado top
Independent top blow molded filters
Filtre a sable soufflé en vanne top
Filtro soffiato top con valvola superiore



Blue Connect Go & complementos
Blue Connect Go & complements
Blue Connect Go & compléments
Blue Connect Go & complementi



Bicicleta acuática
Water bike
Vélo de piscine
Bicicletta acquatica



Lámparas LED
LED lamp
Ampoule LED
Lampada LED

Duchas Showers Douches Docce



Electrolisi de sal
Salt chlorinator
Electrolyse au sel
Elettrolisi salina



BOX



■ Presentación de la empresa

Gre es una empresa con más de 50 años de experiencia en la fabricación de piscinas elevadas.

Como empresa pionera en el sector, somos especialistas y líderes a nivel europeo.

Nuestra apuesta clara por la calidad y seguridad de todos nuestros productos, nos convierte en la referencia fundamental del mercado.

Nuestra empresa ofrece una amplia gama de productos: piscinas elevadas de diferentes formatos y acabados, una completa línea de accesorios para su equipamiento y mantenimiento y una serie de productos químicos diseñados específicamente para el agua de la piscina.

Con el ánimo siempre, de satisfacer al cliente, Gre ha diseñado una estrategia de servicios, cuyo objetivo es ofrecer una solución integral. Nuestra amplia red de Servicios Técnicos, así como nuestros Departamentos de Atención al Cliente, son la mejor prueba de ello. Estos servicios nos permiten asesorarle sobre la opción de piscina y equipamiento más adecuados a sus necesidades.

■ Présentation de l'entreprise

Gre est une société spécialisée dans la fabrication de piscines hors-sol.

Pionnière dans le secteur, notre entreprise est SPÉCIALISTE et LEADER en EUROPE.

Notre pari sur la QUALITÉ et la SÉCURITÉ de tous nos produits nous permet d'être la principale RÉFÉRENCE du marché.

Notre entreprise offre une LARGE GAMME de produits, allant des piscines hors-sol aux tailles et finitions diverses et variées, jusqu'à un éventail complet des accessoires nécessaires à l'équipement et à l'entretien, et une gamme de produits chimiques conçus spécifiquement pour l'eau de la piscine.

Toujours dans le but de satisfaire nos clients, Gre a conçu une stratégie de SERVICES dont l'objectif est d'offrir une réponse et une solution complètes: un important réseau de Services Techniques ainsi qu'un Service Clients. Ces services nous permettent de vous conseiller sur le choix tant de votre piscine que de l'équipement le plus approprié à vos besoins.

■ Company presentation

Gre is a company with more than 50 years experience in manufacturing above-ground pools.

As a pioneer company on its field, we are SPECIALISTS and LEADERS within the European market.

We are considered to be a fundamental market REFERENCE as a result of our clear wager on QUALITY and SECURITY of all our products.

Our company offers a WIDE RANGE of products which includes: different sizes and finishes aboveground pools, a complete range of accessories for their equipment and maintenance and a number of swimming pool chemicals designed specifically for the pool water.

Bearing in mind our customers satisfaction, Gre has designed an important SERVICES strategy whose aim is to offer an integral solution. Our wide network of Technical Services and our Customer Service Departments are the best proof of that. These services help us to identify our customers needs and to advice them on the best pool and equipment according to those needs.

■ Presentazione dell'azienda

La Gre è un'azienda con oltre 50 anni di esperienza nella produzione di piscine smontabili su terra.

Come impresa pioniera nel settore, siamo SPECIALISTI e LEADER a livello EUROPEO.

La nostra chiara scommessa sulla QUALITÀ e sulla SICUREZZA di tutti i nostri prodotti, fa di noi il RIFERIMENTO fondamentale del mercato.

La nostra società offre una VASTA GAMMA di prodotti: piscine elevate di diversi formati e rifiniture, una completa linea di accessori per l'attrezzatura e la manutenzione e una serie di prodotti chimici pensati specificamente per l'acqua della piscina.

Sempre con l'intenzione di soddisfare il cliente, la Gre ha progettato una strategia di SERVIZI il cui scopo è quello di offrire una soluzione integrale. La nostra vasta rete di Servizi Tecnici, così come i nostri Reparti di Servizio al Cliente, ne sono la miglior prova. Tali servizi ci consentono di dare consulenza sulla scelta della piscina e dell'equipaggiamento più idoneo alle vostre necessità.

■ Certificaciones ■ Certifications ■ Certifications ■ Certificazioni

MADE IN EUROPE

Todas las piscinas fabricadas por manufacturas Gre S.A. Son de origen CE - Comunidad Europea.

Toutes les piscines fabriquées par Manufacturas Gre S.A. sont d'Origine CE - Communauté Européenne.

All the pools manufactured by Manufacturas Gre S.A. are of EC - European Community origin.

Tutte le piscine prodotte da Manufacturas Gre S.A. sono di origine CE - Comunità Europea.



ISO 9001

Los procesos utilizados para el diseño, la fabricación y comercialización de piscinas desmontables de Manufacturas Gre S.A., así como la comercialización de productos asociados, están certificados siguiendo los criterios de sistema de Gestión de Calidad según la norma internacional ISO9001:2015, lo cual garantiza regularidad y control en la calidad de nuestros productos y procesos.

Les processus utilisés pour la conception, la fabrication et la commercialisation de piscines hors-sol de Manufacturas Gre S.A., ainsi que la commercialisation de produits associés, sont certifiés conformes aux critères de système de Gestion de Qualité selon la norme internationale ISO9001:2015.

The processes used for the design, manufacturing and commercialisation of dismantable pools by Manufacturas Gre S.A., as well as the commercialisation of associated products, are certified according to the Quality System according to the international ISO9001:2015 standard, which guarantees regularity and control in the quality of our products and processes.

I processi utilizzati per la progettazione, la costruzione e la vendita di piscine smontabili a marchio Manufacturas Gre S.A., oltre alla vendita di prodotti ad esse associati, sono certificati in base ai criteri del sistema di Gestione della Qualità secondo la norma internazionale ISO9001:2015, ciò garantisce la regolarità e il controllo della qualità dei nostri prodotti e dei processi produttivi.



ISO 14001

Gracias a la implantación de un Sistema de Gestión Ambiental según la norma internacional ISO 14001: 2015, Manufacturas Gre S.A. se posiciona como una empresa socialmente responsable. Entre otras ventajas ambientales, optimizamos la gestión de recursos y residuos, reduciendo los impactos ambientales negativos derivados de nuestra actividad o aquellos riesgos asociados a situaciones accidentales.

Grâce à l'implémentation d'un Système de Gestion Environnementale conformément à la norme internationale ISO 14001:2015, Manufacturas Gre S.A. se positionne comme une entreprise socialement responsable. Parmi de nombreux avantages environnementaux, nous optimisons la gestion des ressources et des déchets, réduisant ainsi les impacts environnementaux négatifs et dérivés de notre activité ou les risques associés à des situations d'accidents.

Thanks to the implantation of an Environmental Management System according to the international ISO 14001:2015 standard, Manufacturas Gre S.A. is positioned as a socially responsible company. Among other environmental advantages, we optimise resources and residues, reducing negative environmental impact derived from our activity or those risks associated to accidental situations.

Grazie all'introduzione di un Sistema di Gestione Ambientale secondo la norma internazionale ISO 14001:2015, Manufacturas Gre S.A. si classifica tra le aziende socialmente responsabili. Ciò comporta vantaggi per l'ambiente come l'ottimizzazione della gestione delle risorse, la riduzione degli impatti ambientali negativi derivanti dall'attività di produzione o dei rischi associati a eventi accidentali.



ARBITRAJE DE CONSUMO / CONSUMER ARBITRATION / ARBITRAGE DE CONSOMMATION / ARBITRATO DI CONSUMO

Manufacturas Gre S.A. está adherido a la Junta Arbitral de Consumo como muestra de predisposición a la solución amistosa de cualquier tipo de reclamación por parte de sus clientes.

Manufacturas Gre S.A. est membre du bureau d'Arbitrage de Consommation, comme preuve de prédisposition à la solution amiable de tout type de réclamation de la part de ses clients.

Manufacturas Gre S.A. is adhered to the Consumer Arbitration Directorate evidencing predisposition to a friendly solution to any type of reclamation from its clients.

Manufacturas Gre S.A. aderisce alla Giunta Arbitrale di Consumo come segnale di predisposizione alla soluzione amichevole di qualsiasi tipo di reclamo da parte dei propri clienti.



CE

Los productos distribuidos por Manufacturas Gre S.A. con el marcado CE cumplen todos los requisitos legales vigentes en Europa.

Les produits distribués par Manufacturas Gre S.A. dotés du marquage CE répondent à toutes les obligations légales en vigueur en Europe.

The products distributed by Manufacturas Gre S.A., with the CE marking comply with all the legal requirements in force in Europe.

I prodotti distribuiti da Manufacturas Gre S.A. con il marchio CE rispettano tutti i requisiti legali vigenti in Europa.





EN 16582-1:2015, EN 16582-3:2015, EN 16713-1:2015

Estas certificaciones garantizan que las piscinas, filtros y escaleras fabricados y/o distribuidos por Manufacturas Gre S.A. cumplen con las normativas de seguridad establecidas.

Ces certifications garantissent que les piscines, les filtres et les échelles fabriqués et/ou distribués par Manufacturas Gre S.A. respectent les normes de sécurité établies.

These certifications guarantee that the pools, filters and stepladders manufactured and/or commercialised by Manufacturas Gre S.A. comply with the established safety regulations.

Queste certificazioni garantiscono che le piscine, i filtri e le scalette prodotti e/o distribuiti da Manufacturas Gre S.A. rispettano le normative di sicurezza previste.



ECOEMBES

Manufacturas Gre S.A. está adherida a un sistema de recogida y reciclaje selectivo de los materiales que pone en el mercado con el fin último de preservar el medio ambiente.

Manufacturas Gre S.A. est membre d'un système de collecte et de recyclage sélectif des matériaux qu'elle met sur le marché, dans le but de préserver l'environnement.

Manufacturas Gre S.A. is adhered to a system for the selective collection and recycling of the materials it puts on the market in order to conserve the environment.

Manufacturas Gre S.A. aderisce a un sistema di raccolta differenziata e riciclaggio dei materiali immessi sul mercato, in un'ottica di preservazione dell'ambiente.



REACH

Manufacturas Gre S.A. cumple con el reglamento Reach asegurando que todas las sustancias químicas que comercializa están registradas.

Manufacturas Gre S.A. respecte le règlement Reach, qui garantit que toutes les substances chimiques qu'elle commercialise sont enregistrées.

Manufacturas Gre S.A. complies with the Reach regulation ensuring that all the chemical substances it commercialises are registered.

Manufacturas Gre S.A. rispetta il regolamento Reach garantendo la registrazione di tutte le sostanze chimiche immesse sul mercato dall'azienda.

RoHS

ROHS

Manufacturas Gre S.A. cumple esta directiva para proteger el medio ambiente y la salud de las personas, evitando el uso de determinadas sustancias en aparatos eléctricos y electrónicos.

Manufacturas Gre S.A. respecte cette directive afin de protéger l'environnement et la santé des personnes, évitant ainsi l'utilisation de substances déterminées dans les appareils électriques et électroniques.

Manufacturas Gre S.A. complies with this directive to protect the environment and health of persons, avoiding the use of determined substances in electrical and electronic devices.

Manufacturas Gre S.A. rispetta questa normativa per proteggere l'ambiente e la salute delle persone, evitando l'utilizzo di determinate sostanze su dispositivi elettrici ed elettronici.



PEFC

Manufacturas Gre S.A. cumple con los requisitos del Estándar de Cadena de Custodia de Productos Forestales PEFC ST 2002:2013.

Manufacturas Gre S.A. respecte les conditions du Standard de la Chaîne de Contrôle de Produits Forestiers PEFC ST 2002:2013.

Manufacturas Gre S.A. complies with the requirements of the Programme for the Endorsement of Forest Certification PEFC ST 2002:2013.

Manufacturas Gre S.A. rispetta i requisiti previsti dallo Standard della catena di custodia dei prodotti forestali PEFC ST 2002:2013.



Origine France Garantie

Origine France Garantie es una marca cuyo principio es simple: 2 criterios son obligatorios.
· Al menos el 50% del costo unitario es francés.
· El producto tiene sus características esenciales en Francia.

La etiqueta permite a las empresas **promover la producción en Francia** y los consumidores pueden optar por **comprar producto francés**.

Origine France Garantie est une marque dont le principe d'obtention est simple : 2 critères cumulatifs sont obligatoires.

· au moins 50 % du prix de revient unitaire est français
· le produit prend ses caractéristiques essentielles en France.

Le label permet aux entreprises de promouvoir **le produire en France** et aux consommateurs de pouvoir **choisir d'acheter français**.

Origine France Garantie is a brand whose principle of achievement is simple: 2 cumulative criteria are mandatory.

· At least 50% of the unit cost is French.
· The product has its essential characteristics in France.

The label allows companies to **promote production in France** and **consumers can choose to buy French**.

Origine France Garantie è un marchio il cui principio di realizzazione è semplice: 2 criteri cumulativi sono obbligatori.

· Almeno il 50% del costo unitario è francese.
· Il prodotto ha le sue caratteristiche essenziali in Francia.

L'etichetta consente alle aziende di **promuovere Prodotto in Francia** e i consumatori **possono scegliere di acquistare il francese**.



PISCINA ENTERRADA DE PARED DE ACERO

LINER: Tratamiento Anti-ultravioleta que retrasa el envejecimiento del P.V.C.

CHAPA: Laminada en frío con tratamiento de galvanización, fosfatación e imprimación.

Troquelada para skimmer, válvulas de retorno y limpiafondos y focos.

PISCINES ENTERRÉES PAROI ACIER

LINER: Traitement anti-ultraviolets contre le vieillissement du P.V.C.

TÔLE: Tôle laminée à froid et traitée par galvanisation, phosphatage, couche d'apprêt et laquage.

Découpage pour le skimmer, la buse de refoulement et la prise balai. Prédécoupe pour les projecteurs.

IN-GROUND STEEL WALL POOL

LINER: Anti-ultraviolet treatment to slow down P.V.C aging.

PLATE: Galvanized, phosphatized, primed and lacquered cold-rolled plate.

Die cut for skimmer, return valve and cleaner openings and lights.

PISCINE INTERRATA CON PARETI IN ACCIAIO

LINER: Trattamento Anti-ultravioletti - Ritarda l'invecchiamento del P.V.C.

PANNELLO: Laminata a freddo con trattamento di galvanizzazione, fosfatazione e preparazione.

Stampigliatura per Skimmer, valvola di ritorno e puliscifondi e spot.



**MADE
IN
EU**

in-ground pool

serie **MOOREA**



EAN 13

Model	Dimensions (cm)	Height (cm)	Volume (l)	Weight (kg)	Panel Size (cm)	Flow Rate (m³/h)	Filter	EAN 13
KPEOV8059M	800x400	150	38.840	217/232	1/120x80 1/90x80	10	✓	8 4 1208 1 269597
KPEOV7059M	700x320	150	27.470	189/232	1/120x80 1/90x80	10	✓	8 4 1208 1 269603
KPEOV6059M	600x320	150	24.420	164/232	1/120x80 1/90x80	10	✓	8 4 1208 1 269610
KPEOV5059M	500x300	150	16.015	139/232	1/120x80 1/90x80	10	✓	8 4 1208 1 269627



MEDIDA PISCINA
POOL SIZE
DIMENSIONS PISCINE
MISURA PISCINA

ESPACIO NECESARIO
NECESSARY SPACE
ESPACE NECESSAIRE
SPAZIO NECESSARIO

Model	Dimensions (cm)	Necessary Space (cm)
KPEOV8059M	800x400x150	1000x600x165
KPEOV7059M	700x320x150	900x520x165
KPEOV6059M	600x320x150	800x520x165
KPEOV5059M	500x300x150	700x500x165



Liner PVC azul
75/100
PVC blue liner
75/100
Liner bleu PVC
75/100
Liner blu PVC
75/100

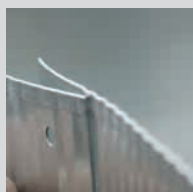

Chapa prelacada
70/100
Prelacquered steel
70/100
Tôle prélaquée
70/100
Lamiera laccata
70/100

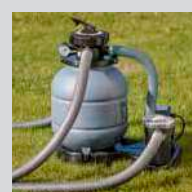

Depuradora arena
(Caudal grupo 10 m³/h)
Sand filter
(Flow group 10 m³/h)
Filtre à sable
(Débit groupe 10 m³/h)
Filtro a sabbia
(Portata gruppo 10 m³/h)



EAN 13

KPE4259M	Ø420 cm	150 cm	18.840 l	126/232 kg	1/120x80 1/90x80	10m ³ /h	✓	8 412081 269634
----------	---------	--------	----------	------------	---------------------	---------------------	---	-----------------



MEDIDA PISCINA
POOL SIZE
DIMENSIONS PISCINE
MISURA PISCINA

ESPACIO NECESARIO
NECESSARY SPACE
ESPACE NECESSAIRE
SPAZIO NECESSARIO

KPE4259M

Ø420x150 cm

Ø620x165 cm



Escalera fácil acceso:
3 peldaños - Inox.
Easy access ladder:
3 steps - Stainless steel
Échelle d'accès facile:
3 marches - Acier
inoxidable
Scala di accesso facile:
3 gradini - Inox



Manta protectora
(Poliéster)
Bottom
protectiveblanket
(Polyester)
Tapis de sol en feutre
(Polyester)
Telo di protezione
(Poliestere)



Skimmer, manguera,
racordería...
Skimmer, hose,
fittings...
Skimmer, tuyau,
raccords...
Skimmer, tubo,
raccordería...

in-ground pool

serie

MADAGASCAR



EAN 13

Model	Dimensions (cm)	Depth (cm)	Volume (l)	Weight (kg)	Box Size (cm)	Flow Rate (m³/h)	Filter	EAN 13
KPEOV8059	800x400	150	38.840	217/224	1/120x80 1/90x80	10	✓	8 412081 269320
KPEOV7059	700x320	150	27.470	189/224	1/120x80 1/90x80	10	✓	8 412081 269337
KPEOV6059	600x320	150	24.420	164/224	1/120x80 1/90x80	10	✓	8 412081 269344
KPEOV5059	500x300	150	16.015	139/224	1/120x80 1/90x80	10	✓	8 412081 258904



MEDIDA PISCINA
POOL SIZE
DIMENSIONS PISCINE
MISURA PISCINA

ESPACIO NECESARIO
NECESSARY SPACE
ESPACE NECESSAIRE
SPAZIO NECESSARIO

Model	Dimensions (cm)	Necessary Space (cm)
KPEOV8059	800x400x150	1000x600x165
KPEOV7059	700x320x150	900x520x165
KPEOV6059	600x320x150	800x520x165
KPEOV5059	500x300x150	700x500x165



Liner PVC azul
75/100
PVC blue liner
75/100
Liner bleu PVC
75/100
Liner blu PVC
75/100

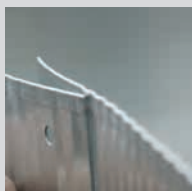

Chapa prelacada
70/100
Prelacquered
steel 70/100
Tôle prélaquée
70/100
Lamiera laccata
70/100



Depuradora arena
(Caudal grupo 10 m³/h)
Sand filter
(Flow group 10 m³/h)
Filtre à sable
(Débit groupe 10 m³/h)
Filtro a sabbia
(Portata gruppo 10 m³/h)



EAN 13

KPE4259	Ø420 cm	150 cm	18.840 l	126/224 kg	1/120x80 1/90x80	10m ³ /h	✓	8 4 12081 269351
---------	---------	--------	----------	------------	---------------------	---------------------	---	------------------



MEDIDA PISCINA
POOL SIZE
DIMENSIONS PISCINE
MISURA PISCINA

ESPACIO NECESARIO
NECESSARY SPACE
ESPACE NECESSAIRE
SPAZIO NECESSARIO

KPE4259

Ø420x150 cm

Ø620x165 cm



Escalera:
4 peldaños - Inox.
Ladder:
4 steps - Stainless steel
Échelle: 4 marches -
Acier inoxydable
Scala:
4 gradini - Inox



Manta protectora
(Poliéster)
Bottom protectiveblanket
(Polyester)
Tapis de sol en feutre
(Polyester)
Telo di protezione
(Poliestere)



Skimmer, manguera,
racordería...
Skimmer, hose,
fittings...
Skimmer, tuyau,
raccords...
Skimmer, tubo,
raccordería...

in-ground pool

serie **SUMATRA**



EAN 13

Model	Dimensions (LxW)	Depth	Capacity (l)	Weight (kg)	Box Dimensions (LxWxH)	Flow Rate (m³/h)	Installation	Barcode
KPEOV8027	800x400 cm	120 cm	30.000 l	193/222 kg	1/120x80 1/90x80	10m³/h	√	8 4 12081 269368
KPEOV7027	700x320 cm	120 cm	21.210 l	173/222 kg	1/120x80 1/90x80	10m³/h	√	8 4 12081 269375
KPEOV6027	600x320 cm	120 cm	17.850 l	154/222 kg	1/120x80 1/90x80	10m³/h	√	8 4 12081 269382
KPEOV5027	500x300 cm	120 cm	12.360 l	134/222 kg	1/120x80 1/90x80	10m³/h	√	8 4 12081 258959



MEDIDA PISCINA
POOL SIZE
DIMENSIONS PISCINE
MISURA PISCINA

ESPACIO NECESARIO
NECESSARY SPACE
ESPACE NECESSAIRE
SPAZIO NECESSARIO

Model	Dimensions (LxWxD)	Required Space (LxWxD)
KPEOV8027	800x400x120 cm	1000x600x135 cm
KPEOV7027	700x320x120 cm	900x520x135 cm
KPEOV6027	600x320x120 cm	800x520x135 cm
KPEOV5027	500x300x120 cm	700x500x135 cm



Liner PVC azul
75/100
PVC blue liner
75/100
Liner bleu PVC
75/100
Liner blu PVC
75/100

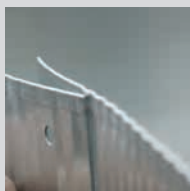

Chapa prelacada
70/100
Prelacquered
steel 70/100
Tôle prélaquée
70/100
Lamiera laccata
70/100



Depuradora arena
(Caudal grupo 10 m³/h)
Sand filter
(Flow group 10 m³/h)
Filtre à sable
(Débit groupe 10 m³/h)
Filtro a sabbia
(Portata gruppo 10 m³/h)



EAN 13

	Ø420 cm	120 cm	14.540 l	222/102 kg	1/120x80 1/90x80	10m³/h	✓	8 412081 269399
KPE4227	Ø350 cm	120 cm	10.102 l	222/85 kg	1/120x80 1/90x80	10m³/h	✓	8 412081 262635
KPE3527								



MEDIDA PISCINA
POOL SIZE
DIMENSIONS PISCINE
MISURA PISCINA

ESPACIO NECESARIO
NECESSARY SPACE
ESPACE NECESSAIRE
SPAZIO NECESSARIO

KPE4227	Ø420x120 cm	Ø620x135 cm
KPE3527	Ø350x120 cm	Ø550x135 cm



Escalera:
3 peldaños - Inox.
Ladder:
3 steps - Stainless steel
Échelle: 3 marches -
Acier inoxydable
Scala:
3 gradini - Inox



Manta protectora
(Poliéster)
Bottom protectiveblanket
(Polyester)
Tapis de sol en feutre
(Polyester)
Telo di protezione
(Poliestere)



Skimmer, manguera,
racordería...
Skimmer, hose,
fittings...
Skimmer, tuyau,
raccords...
Skimmer, tubo,
racordería...





PISCINAS DE MADERA

LINER: Tratamiento Anti-ultravioleta que retrasa el envejecimiento del P.V.C

MADERA: Fabricadas en Francia en pino silvestre francés y con tratamiento en autoclave clase IV que garantiza la resistencia de la madera contra el ataque de insectos y pudrimiento. 10 años de garantía sobre la madera.

WOODEN POOL

LINER: Anti-ultraviolet treatment to slow down P.V.C aging.

WOODEN: Manufactured in France from pine boards (originating in France), with a class IV autoclave treatment which guarantees its resistance to decay and xylophagous insects attack.

PISCINE BOIS

LINER: Traitement anti-ultraviolets contre le vieillissement du P.V.C.

BOIS: De fabrication française et réalisées à partir de madriers en pin (origine France) bénéficiant d'un traitement par autoclave de classe IV, garantissant une résistance au pourrissement et aux attaques d'insectes xylophages. 10 ans de garantie sur les composants bois de la piscine.

PISCINA IN LEGNO

LINER: Trattamento Anti-ultravioletti - Ritarda l'invecchiamento del P.V.C.

LEGNO: Prodotte in Francia in pino silvestre francese con trattamento in autoclave classe IV che garantisce la resistenza del legno agli insetti e al deterioramento. 10 anni di garanzia sulle parti in legno.



MADE IN EU

■ La madera una historia ■ The wood a story ■ Le bois une histoire ■ Il bosco una storia

PINO SILVESTRE

Manufacturas Gre presenta piscinas con estructuras de madera de **pino silvestre**. Con un planteamiento de desarrollo sostenible, **Manufacturas Gre** cuenta **exclusivamente** con proveedores **locales en Francia**, de bosques de pinos denominados «del país». Asimismo, limitamos el transporte y las emisiones de gases de efecto invernadero. El PINO es la esencia de la clase de uso del autoclave IV, que garantiza resistencia frente a la podredumbre y a los insectos xilófagos.

El denominado pino «del país» presenta **más albura** que los pinos procedentes de bosques septentrionales. Además, ofrece **una zona de impregnación más significativa**, lo que asegura una vida útil superior a los diez años debido a una impregnación profunda en el autoclave. Este último es el único procedimiento normalizado y garantizado que aporta garantías a la durabilidad.

LE PIN SYLVESTRE

Manufacturas Gré propose des piscines à ossatures bois en pin sylvestre. Dans une logique de développement durable, **Manufacturas Gré** s'approvisionne **localement et exclusivement en France**, auprès de forêts de pin dit « de pays ». Nous limitons ainsi le transport et les émissions de gaz à effet de serre.

Le PIN est l'essence idéale pour la classe d'emploi autoclave IV, garantissant une résistance au pourrissement et aux attaques d'insectes xylophages. Le pin dit « de pays » présente **plus d'aubier** que les pins des forêts du nord. Il offre ainsi **une zone d'impregnation plus importante** lui garantissant une durée de service supérieure à 10 ans grâce à l'impregnation profonde en autoclave. Ce dernier est le seul procédé normalisé et certifié apportant des garanties dans la durée.



SCOTS PINE

Manufacturas Gre presents pools with **Scots pine** wood structures. With its proposal for sustainable development, **Manufacturas Gre** exclusively uses **local French** suppliers, from forests of pine wood denominated «local pine». Likewise, we limit transport and emissions of greenhouse gases. PINE is the essence of the class used in Autoclave IV that guarantees resistance against rot and xylophagous insects.

The so-called «local pine» has **more whiteness** than pines coming from northern forests. In addition, it offers **a more significant impregnation area**, which assures a useful life above ten years due to deeper impregnation in the autoclave. This latter is the only standardised and guaranteed process proving guaranteed durability.

PINO SILVESTRE

Manufacturas Gre è lieta di presentare le piscine con struttura in legno di **pino silvestre**.

Con un approccio rivolto allo sviluppo sostenibile, **Manufacturas Gre** si affida **esclusivamente** a fornitori **locali in Francia**, di legno proveniente da foreste di pini "autoctoni".

Vengono limitati il trasporto e le emissioni di gas serra.

Il PINO subisce un trattamento in autoclave classe IV, che garantisce resistenza al deterioramento e agli insetti xilofagi.

Il cosiddetto pino "autoctono" presenta una quantità maggiore di **alborno** rispetto ai pini provenienti dalle foreste settentrionali. Offre inoltre **una maggiore area di impregnazione**, che garantisce una durata utile superiore a dieci anni grazie a una profonda impregnazione in autoclave. Quest'ultima è l'unica procedura standardizzata e garantita che apporta garanzie di durabilità.



CERTIFICACIONES

PRODUCTOS CERTIFICADOS POR **PEFC**
(Programa europeo de certificación forestal)
Licencia número: PEFC/14-38-00166
Pioneros en la certificación forestal en Francia, PEFC acoge en la actualidad 8,1 millones de hectáreas, 62 000 propietarios y 3000 empresas del sector maderero forestal (explotaciones, aserraderos, industrias de transformación, construcciones, intermediarios comerciales, distribuidores, industrias papeleras, imprentas, editoriales, etc.). En conjunto, aportan al consumidor la garantía de que el producto que lleve la marca PEFC se enmarca en una estrategia responsable de gestión forestal sostenible.

CERTIFICATION

PRODUITS LABELLISÉS **PEFC**
(Programme Européen des Forêts Certifiées)
N° licence : PEFC/14-38-00166
Pionnier de la certification forestière en France, PEFC représente aujourd'hui 8.1 millions d'hectares, 62 000 propriétaires et 3 000 entreprises de la filière forêt-bois (exploitants, scieries, transformateurs, constructeurs, négociants, artisans, distributeurs, papetiers, imprimeurs, éditeurs...). Ensemble ils apportent au consommateur la garantie qu'un produit portant la marque PEFC s'inscrit dans une démarche responsable de gestion durable de la forêt.

www.pefc.es / www.pefc-france.org

Nuestra madera procede de bosques gestionados de forma responsable y sostenible, certificados como PEFC™. Our wood comes from responsibly and sustainably managed forests, certified with PEFC™. Notre bois est issu de forêts gérées de façon responsable et durable, certifiées PEFC™. Il nostro legno proviene da foreste gestite in modo responsabile e sostenibile, certificate come PEFC™.

CERTIFICATION

PRODUCTS CERTIFIED BY **PEFC** (European programme for forestry certification)
License number: PEFC/14-38-00166
Pioneers in forestry certification in France, PEFC currently includes 8.1 million hectares, 62,000 owners, and 3,000 forest timber sector companies (exploitations, sawmills, transformation industries, constructions, commercial intermediaries, distributors, paper industries, printers, publishers, etc.). Overall, they provide the consumer with the guarantee that the product with PEFC marking is framed within a responsible strategy of sustainable forest management.

CERTIFICAZIONE

PRODOTTI CERTIFICATI DAL **PEFC**
(Programma europeo di certificazione forestale)
Licenza numero: PEFC/14-38-00166
Pionieri nella certificazione forestale in Francia, PEFC conta attualmente 8,1 milioni di ettari, 62.000 proprietari e 3000 aziende nel settore del legno (aziende agricole, segherie, industrie di trasformazione, settore edile, intermediari commerciali, distributori, cartiere, stamperie, editorie, ecc.). Uniti nell'intento di offrire ai consumatori la garanzia che il prodotto a marchio PEFC faccia parte di una strategia responsabile per la gestione sostenibile delle foreste.





La certificación **CTB B+** solo indica el uso de un producto de tratamiento conforme a los criterios de la certificación. Pivetau Bois cuenta con la certificación **CTB B+** (con el respaldo de la asociación Arbust). El certificado CTB B+ confirma la utilización de productos de tratamiento con la **certificación CTB B+**, así como **la conformidad del proceso y su eficacia**.

Le CTB P+ atteste uniquement de l'utilisation d'un produit de traitement conforme aux critères de la certification. Pivetau Bois est certifié CTB B+ (soutenu par l'association Arbust). Le certificat CTB B+ atteste de l'utilisation de produit de traitement certifié CTB P+ et **atteste aussi de la conformité du processus et de son efficacité**.

The **CTB B+** certification only indicates the use of a treatment product in accordance to certification criteria. Pivetau Bois has the CTB B+ certification (with the backing of the Arbust association). The **CTB B+** confirms the use of treatment products with **CTB B+ certification**, as well as **process conformity and efficiency**.

La certificazione **CTB B +** indica l'utilizzo di un prodotto di trattamento conforme ai criteri della certificazione. Pivetau Bois è in possesso della certificazione **CTB B +** (con il supporto dell'associazione Arbust). La certificazione **CTB B +** conferma l'utilizzo di prodotti per il trattamento con la certificazione **CTB B +**, nonché **la conformità del processo e la sua efficacia**.

■ Tratamiento autoclave ■ Autoclave treatment ■ Le traitement autoclave ■ Trattamento in autoclave

El tratamiento en el autoclave es **la mejor solución** para proteger las maderas expuestas de forma directa a la intemperie o en contacto con el suelo y consiste en **impregnar conservantes hasta el núcleo de la madera**.

Le traitement par autoclavage est **la meilleure solution** pour protéger les bois exposés directement aux intempéries ou en contact avec le sol et consiste à **imprégner des agents de conservation jusqu'au cœur du bois**.

Treatment in the autoclave is **the best solution** for protecting wood directly exposed to outdoor weather or in contact with the ground and consists of **impregnating preservatives into the core of the wood**.

Il trattamento in autoclave è la **soluzione migliore** per proteggere il legno esposto direttamente alle intemperie o a contatto con il terreno e consiste **nell'impregnare conservanti nel nucleo del legno**.



INSTALACIÓN

Libre elección de instalación: en superficie, semienterrada o enterrada. En estos dos últimos casos, es obligatorio acondicionar un drenaje en todo el perímetro del vaso (consultar el aviso).

IMPLANTATION

Implantation libre de choix : hors-sol, semi-enterrée jusqu'à complètement enterrée. En cas d'implantation semi-enterrée ou totalement enterrée, il est impératif de réaliser un drainage sur toute la périphérie du bassin (cf notice).

INSTALLATION

Free choice of installation: above ground, semi in-ground or in-ground. In these two latter cases, there must be drainage in the entire perimeter of the pool (check warning).

INSTALLAZIONE

Libera installazione: superficiale, semi-interrata o interrata. In questi ultimi due casi, è obbligatorio predisporre un drenaggio attorno al perimetro della vasca (consultare le specifiche indicazioni).

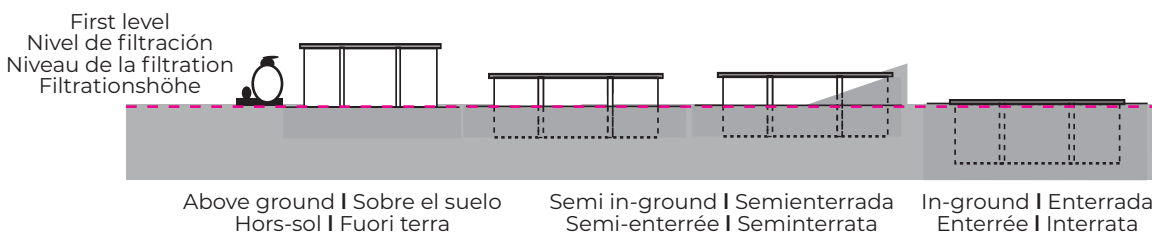

Todas las dimensiones de nuestras piscinas se presentan con una tolerancia de +/- 3% · Todas las dimensiones de nuestras piscinas se presentan con una tolerancia de +/- 3% · Toutes les dimensions de nos piscines sont données avec une tolérance de +/- 3% · Tutte le dimensioni delle nostre piscine vengono indicate con una tolleranza di +/- 3%.

■ Piscine de madera ■ Wood pools ■ Les piscines bois ■ Piscine in legno

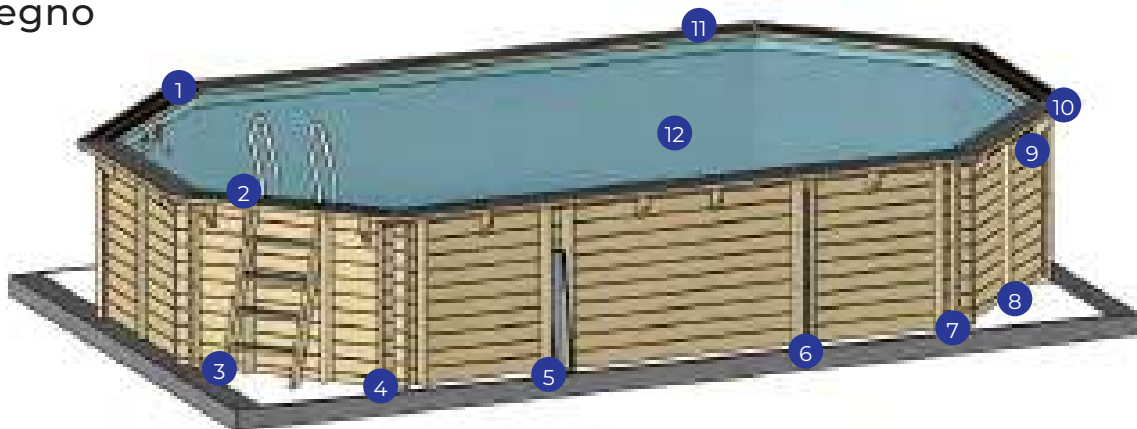

1: Stainless steel corners According to model **2: Stainless steel ladder** Fixed - 3 non-slip steps **3: Wood ladder** Possibility of readjusting the wood ladder according to the height of the pool. **4: Angular finishing** The wood coating at the ends of the boards provides greater aesthetics to the pool **5: Wedges** Reinforcement wedges for fixing on concrete slab **6: Nerves** Metallic nerves for embedding in concrete slab **7: Tongue and groove series** Boards are fitted to each other by a cross at the end - Simple tongue and groove facilitating assembly and that way avoiding risk of breakage. **8: Vertical reinforcements** Vertical resistance thanks to wood reinforcements **9: Corbels** Corbels are used to sustain the edges **10: Plates under edges** Allow reinforcing the installation of edges on the corners **11: Wood edges** Made from Scots pine treated in class IV autoclave - Single (190 mm) or double (2 x 145 mm) according to model - Thickness of 28 mm or of 36 mm according to model **12: Liner** Baguettes Hung

1: Embellecedor de esquinas inoxidable Según el modelo **2: Escalera inoxidable** Fija - 3 Escalones antideslizantes **3: Escalera de madera** Posibilidad de reajustar la escalera de madera según la altura del vaso **4: Embellecedor angular** El revestimiento de madera en los extremos de los tablonos perfecciona la estética del vaso **5: Cuñas metálicas** Cuñas de refuerzo para fijar sobre la losa de hormigón **6: Vigas** Vigas metálicas para encastrar en la losa de hormigón **7: Conjunto de ranura y lengüeta** Encaje de tablonos entre ellos mediante cruce de los extremos - Ranura y lengüeta sencillas para facilitar el montaje y así evitar el riesgo de rotura **8: Refuerzos verticales** Resistencia vertical gracias a los refuerzos de madera **9: Tacos de madera** Los tacos se emplean para sostener las playas **10: Tacos bajo playa** Permiten reforzar la instalación de las playas en las esquinas **11: Playas de madera** De pino silvestre tratado en autoclave de clase IV - Simple (190 mm) o doble (2 x 145 mm) según el modelo - Grosor de 28 mm o de 36 mm según el modelo **12: Liner** Perfil colgate

1 : Cache Angles Inox Selon modèle **2: Échelle Inox** Amovible - 3 marches anti-dérapantes **3: Échelle Bois** Possibilité de réajuster l'échelle bois selon la hauteur du bassin **4: Cache L** Un habillage bois aux extrémités des madriers vient parfaire l'esthétisme du bassin **5: Sabots** Renforts sabot à fixer sur la dalle béton **6: Berceaux** Berceaux métalliques à noyer dans la dalle béton **7: Assemblage Rainure languette** Emboîtement des madriers les uns sur les autres en se croisant à leurs extrémités - Simple rainure / languette pour faciliter le montage et éviter ainsi le risque de casse **8: Renforts verticales** Résistance verticale grâce aux renforts bois **9: Consoles** Les consoles sont destinées à soutenir les margelles **10: Plaques sous margelles** Permet de renforcer l'assemblage des margelles dans les angles **11: Margelles Bois** En pin Sylvestre traité autoclave classe IV - Simple (190 mm) ou double (2 x 145 mm) selon modèle - Épaisseur 28 mm ou 36 mm selon modèle **12: Liner** Baguettes Hung

1: Rivestimento per angoli in acciaio inox In base al modello **2: Scaletta in acciaio inox** Fissa - 3 scalini antiscivolo **3: Scaletta in legno** Possibilità di regolare la scaletta in base all'altezza della vasca **4: Rivestimento angolare** Il rivestimento in legno posto alle estremità dei pannelli perfeziona l'estetica della vasca **5: Cunei** Cunei di rinforzo da fissare sulla lastra in calcestruzzo **6: Nervature** Nervature metalliche da incastrare nella lastra in calcestruzzo **7: Set composto da scanalatura e linguetta** Incastrare i pannelli tra loro incrociando le estremità - Scanalatura e linguetta per facilitare il montaggio evitando il rischio di rottura **8: Rinforzi verticali** Resistenza verticale grazie ai rinforzi in legno **9: Mensole** Le mensole vengono utilizzate per sostenere i bordi **10: Piastre poste sotto al bordo** Permettono di rinforzare i bordi negli angoli **11: Bordi in legno** Realizzati in legno di pino silvestre con trattamento in autoclave in classe IV - Semplice (190 mm) o doppio (2 x 145 mm) a seconda del modello - Spessore 28 mm o 36 mm a seconda del modello **12: Liner** Baguettes Hung

■ Refuerzos de estructura ■ Structural reinforcements ■ Renforts de structure ■ Rinforzi strutturali

CUÑA METÁLICA :

La cuña se fija sobre la losa de hormigón. Por lo tanto, permite construir la losa, con un espesor mínimo de 15 cm, antes de montar el vaso (consultar el manual de instalación y el vídeo de montaje). Los refuerzos tienen un revestimiento de madera para garantizar su integración y su estética.

LES SABOTS :

Le sabot vient se fixer sur la dalle en béton. Il est donc possible de réaliser la dalle, épaisseur 15 cm minimum, préalablement au montage du bassin (cf. notice de montage et vidéo de montage). Les renforts de structures reçoivent un habillage bois, pour une intégration et un esthétisme assuré.



WEDGE :

The wedge is fixed on the concrete slab. Therefore, this allows preparing the concrete slab, with minimum thickness of 15 cm before assembling pool (check installation warning and assembly video). Structural reinforcements are coated with wood to guarantee their integration and aesthetics.

CUNEO METALLICO :

Il cuneo viene fissato sulla lastra di calcestruzzo. Consente pertanto di costruire la lastra, con uno spessore minimo di 15 cm, prima di montare la vasca (consultare le indicazioni e il video di montaggio). I rinforzi strutturali sono provvisti di una copertura in legno che ne migliorano il posizionamento e l'estetica.

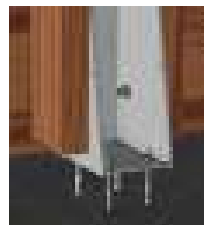
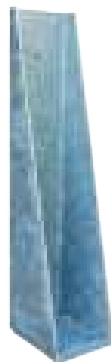

VIGAS METÁLICAS (IPE):

Las vigas metálicas se encastran en la losa de hormigón, con un espesor mínimo de 17 cm. Su colocación forma parte del proceso de montaje de la estructura (consultar el manual de instalación).

LES BERCEAUX (IPE):

Les berceaux métalliques sont à noyer dans la dalle béton, épaisseur 17 cm minimum. Leur pose fait partie intégrante du montage de la structure (cf. notice de montage).

BURIED STEEL BEAM (IPE):

Buried steel beam are embedded in the concrete slab, with a minimum thickness of 17 cm. Their installation is part of the structure assembly process (check installation warning).

BARRA DI ACCIAIO (IPE):

La barra di acciaio vengono incassate nella lastra di calcestruzzo, con uno spessore minimo di 17 cm. Il loro posizionamento fa parte del processo di assemblaggio della struttura (vedere indicazioni per il montaggio).

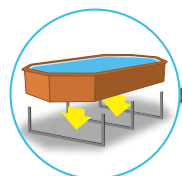

SISTEMA DE OMEGAS:

Viga de acero enterrada de 15x15 cm. Es necesario excavar y preparar el terreno para nivelarlo. Losa de hormigón opcional.

RENFORTS ENTERRÉS:

Poteaux en acier à enterrer de 15x15 cm. Il est nécessaire de décaper votre terrain et de mettre le terrassement de niveau. Chape béton facultative.

OMEGA SYSTEM:

15x15 cm buried steel beam. You should excavate and prepare the land for levelling. Optional concrete slab.

SISTEMA OMEGA:

Barra di acciaio interrata da 15x15 cm. È necessario scavare e preparare il terreno per livellarlo. Basamento di calcestruzzo opzionale.

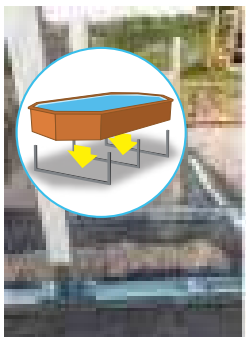

wooden pool VIOLETTE · ANANAS · VANILLE · LILI

H. 1,24 - H. 1,19 - H. 1,05



REFERENCIA RÉFÉRENCE	REFERENCE RIFERIMENTO
 CÓDIGO EAN GENCOD	EAN CODE CODICE A BARRE
 EXTERIORES EXTÉRIEURES	OUTSIDE ESTERNO
 INTERIORES INTÉRIEURES	INSIDE INTERNI
 VOLUMEN DE AGUA VOLUME D'EAU	WATER VOLUME VOLUME DI ACQUA
 ESTRUCTURA STRUCTURE	STRUCTURE STRUTTURA
 LINEA DE AGUA LIGNE D'EAU	WATER LINE LINEA DELL'ACQUA
 ESTRUCTURA STRUCTURE	STRUCTURE STRUTTURA
 PLAYAS MARGELLES	EDGES BORDI
 ESPESOR MADERA ÉPAISEUR MADRIER	WOOD THICKNESS DIMENSIONE
 LINER	
 FILTRACIÓN FILTRATION	FILTRATION FILTRO
 PROTECTOR DE FONDO FEUTRE DE FOND	FLOOR PROTECTOR PROTEZIONE DEL FONDO
 PROTECTOR DE PARED FEUTRE DE PAROI	WALL PROTECTOR COPERTURA DELLA PARETE
 ESCALERA INTERIOR ÉCHELLE INTÉRIEURE	INSIDE LADDER SCALA INTERNA
 ESCALERA EXTERIOR ÉCHELLE EXTÉRIEURE	OUTSIDE LADDER SCALA ESTERNA
 TERRENO SUPPORT	LAND TERRENO
 PALET	
 IMPLANTATION	

NEW
2020

VIOLETTE

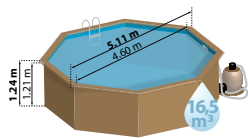

ANANAS

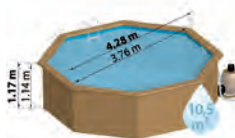

VANILLE

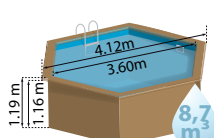

VANILLE FIRST

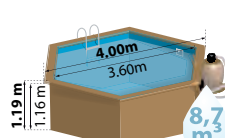

LILI



790085
LDD: 790085D

790210
LDD: 790210D

790083
LDD: 790083D

790082
LDD: 790082D

790080
LDD: 790080D

3605217900852
LDD: 8412081003276

3605217902108
LDD: 3605217902122

3605217900838
LDD: 8412081003252

3605217900821
LDD: 8412081003245

3605217900807
LDD: 8412081003221

Ø 5,11 x H. 1,24 m

Ø 4,28 x H. 1,17 m

Ø 4,10 x H. 1,19 m

Ø 4,00 x H. 1,19 m

Ø 2,95 x H. 1,05 m

Ø 4,60 x H. 1,21 m

Ø 3,76 x H. 1,14 m

Ø 3,60 x H. 1,16 m

Ø 3,60 x H. 1,16 m

Ø 2,55 x H. 1,01 m

16,5 m³

10,5 m³

8,7 m³

8,7 m³

4 m³



1,11 m

1,04

1,06 m

1,06 m

1,06 m

Pino silvestre francés y autoclave clase IV · Pine boards originating in France, with a class IV autoclave · Pin sylvestre origine France autoclave classe IV · pino silvestre francese con trattamento in autoclave classe IV - Certificado · Certificate · Certifié · Certificato PEFC

Ancho · Width · Largeur · Larghezza: 29 cm
Espesor · Thickness · Épaisseur · Dimensione: 2,8 cm
Embellecedores metálicos · metal covers · caches angles inox · protezione metallico

Ancho · width · largeur · larghezza: 19 cm
Espesor · Thickness · épaisseur · dimensione: 2,8cm

46 mm

46 mm

46 mm

46 mm

46 mm

75/100^e uni

75/100^e uni

50/100^e uni

50/100^e uni

50/100^e uni

FILTRO DE ARENA · SAND FILTER · FILTRATION À SABLE · FILTRO A SABBIA

Aqualoon

6 m³/h

6 m³/h

4 m³/h

4 m³/h

4 m³/h

Espesor · Thickness · Épaisseur · Dimensione
200 g/m²

✓

✓

✓

-

-

ACERO INOXIDABLE · STAINLESS STEEL · ACIER INOXIDABLE · ACCIAIO INOX

Escalera seguridad
plataforma
Safety ladder platform
Échelle sécurité
plateforme · Scala di
sicurezza piattaforma

MADERA · WOOD · BOIS · LEGNO

Losa de hormigón opcional · Optional concrete slab · Chape béton facultative · Basamento di calcestruzzo opzionale

484 x 484 x H 10 cm
2,34 m³

410 x 410 x H 10 cm
1,68 m³

406 x 406 x H 10 cm
1,64 m³

306 x 306 x H 10 cm
0,94 m³

L 200 x I 120 x H 47,6 cm
780 kg
L 80 x I 120 x H 78 cm
120 kg

L 180 x I 105 x H 75 cm
690 kg
L 80 x I 120 x H 78 cm
115 kg

L 208 x I 120 x H 50 cm
540 kg
L 80 x I 120 x H 78 cm
105 kg

L 208 x I 120 x H 50 cm
520 kg
L 80 x I 120 x H 78 cm
84 kg

L 150 x I 120 x H 54 cm
360 kg
L 80 x I 120 x H 115 cm
54 kg



wooden pool AVILA · SEVILLA · VERMELA

H. 1,46



REFERENCIA RÉFERENCE	REFERENCE RIFERIMENTO
 CÓDIGO EAN GENCOD	EAN CODE CODICE A BARRE
 EXTERIORES EXTÉRIEURES	OUTSIDE ESTERNO
 INTERIORES INTÉRIEURES	INSIDE INTERNI
 VOLUMEN DE AGUA VOLUME D'EAU	WATER VOLUME VOLUME DI ACQUA
 ESTRUCTURA STRUCTURE	STRUCTURE STRUTTURA
 LINEA DE AGUA LIGNE D'EAU	WATER LINE LINEA DELL'ACQUA
 ESTRUCTURA STRUCTURE	STRUCTURE STRUTTURA
 PLAYAS MARGELLES	EDGES BORDI
 ESPESOR MADERA ÉPAISEUR MADRIER	WOOD THICKNESS DIMENSIONE
 LINER	
 FILTRACIÓN FILTRATION	FILTRATION FILTRO
 PROTECTOR DE FONDO FEUTRE DE FOND	FLOOR PROTECTOR PROTEZIONE DEL FONDO
 PROTECTOR DE PARED FEUTRE DE PAROI	WALL PROTECTOR COPERTURA DELLA PARETE
 ESCALERA INTERIOR ÉCHELLE INTÉRIEURE	INSIDE LADDER SCALA INTERNA
 ESCALERA EXTERIOR ÉCHELLE EXTÉRIEURE	OUTSIDE LADDER SCALA ESTERNA
 TERRENO SUPPORT	LAND TERRENO
 PALET	
 IMPLANTATION	

AVILA

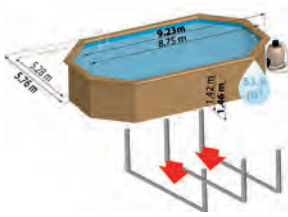

790209
LDD: **790209D**

3605217902092
LDD: 3605217902160

9,23 x 5,76 x H. 1,46 m

8,75 x 5,28 x 1,42 m

53,8 m³



VIGAS METÁLICAS · BURIED STEEL BEAM
LE BERCEAU · BARRA DI ACCIAIO (IPE SYSTEM)

1,36 m

SEVILLA

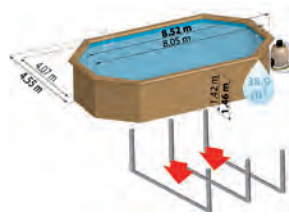

790208
LDD: **790208D**

3605217902085
LDD: 3605217902153

8,52 x 4,55 x H. 1,46 m

8,05 x 4,07 x 1,42 m

38,9 m³



CUÑA METÁLICA · WEDGE
LE SABOT · CUNEO METALLICO

1,36 m

VERMELA

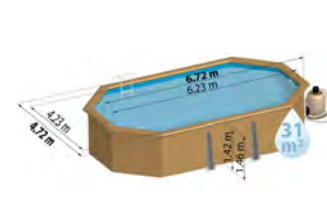

790098
LDD: **790098D**

3605217900982
LDD: 8412081003498

6,72 x 4,72 x 1,46 m

6,23 x 4,23 x 1,42 m

31 m³

Pino silvestre francés y autoclave clase IV · Pine boards originating in France, with a class IV autoclave · Pin sylvestre origine France autoclave classe IV · pino silvestre francese con trattamento in autoclave classe IV - Certificado · Certificate · Certifié · Certificato PEFC

Ancho · Width · Largeur · Larghezza: 29 cm · Espesor · Thickness · Épaisseur · Dimensione: 3,6 cm
Embellecedores metálicos · Metal covers · Caches angles inox · Protezione metallico inox

46 mm

46 mm

46 mm

75/100^e uni

75/100^e uni

75/100^e uni

FILTRO DE ARENA · SAND FILTER · FILTRATION À SABLE · FILTRO A SABBIA

10 m³/h

10 m³/h

8 m³/h

Espesor · Thickness · Épaisseur · Dimensione
200 g/m²



ACERO INOXIDABLE · STAINLESS STEEL · ACIER INOXIDABLE · ACCIAIO INOX

MADERA · WOOD · BOIS · LEGNO

Losa de hormigón obligatorio · Obligatory concrete slab · Chape béton Obligatoire · Basamento di calcestruzzo obbligatorio

944 x 594 x H 17 cm
9,55 m³

874 x 474 x H 17 cm
7,04 m³

674 x 474 x H 17 cm
5,43 m³

L 405 x l 111 x H 79cm - 1460 kg
L 80 x l 200 x H 100 cm - 350 kg

L 405 x l 111 x H 75cm - 1500 kg
L 200 x l 80 x H 100 cm - 370 kg

L 400 x l 120 x H 59cm - 1250 kg
L 200 x l 80 x H 100 cm - 357 kg

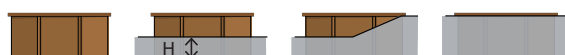

wooden pool SAFRAN · AVOCADO · CAMOMILLE · CANEL

H. 1,33 - H. 1,31 - H. 1,27- H. 1,19



REFERENCIA RÉFÉRENCE	REFERENCE RIFERIMENTO
 CÓDIGO EAN GENCOD	EAN CODE CODICE A BARRE
 EXTERIORES EXTÉRIEURES	OUTSIDE ESTERNO
 INTERIORES INTÉRIEURES	INSIDE INTERNI
 VOLUMEN DE AGUA VOLUME D'EAU	WATER VOLUME VOLUME DI ACQUA
 ESTRUCTURA STRUCTURE	STRUCTURE STRUTTURA
 LINEA DE AGUA LIGNE D'EAU	WATER LINE LINEA DELL'ACQUA
 ESTRUCTURA STRUCTURE	STRUCTURE STRUTTURA
 PLAYAS MARGELLES	EDGES BORDI
 ESPESOR MADERA ÉPAISEUR MADRIER	WOOD THICKNESS DIMENSIONE
 LINER	
 FILTRACIÓN FILTRATION	FILTRATION FILTRO
 PROTECTOR DE FONDO FEUTRE DE FOND	FLOOR PROTECTOR PROTEZIONE DEL FONDO
 PROTECTOR DE PARED FEUTRE DE PAROI	WALL PROTECTOR COPERTURA DELLA PARETE
 ESCALERA INTERIOR ÉCHELLE INTÉRIEURE	INSIDE LADDER SCALA INTERNA
 ESCALERA EXTERIOR ÉCHELLE EXTÉRIEURE	OUTSIDE LADDER SCALA ESTERNA
 TERRENO SUPPORT	LAND TERRENO
 PALET	
 IMPLANTATION	

LE · GRENADE

NEW
2020

SAFRAN



AVOCADO



CAMOMILLE



CANELLE



GRENADE



790089
LDD: 790089D

790203
LDD: 790203D

790202
LDD: 790202D

790087
LDD: 790087D

790086
LDD: 790086D

3605217900890
LDD: 8412081003313

3605217902030
LDD: 3605217902146

3605217902023
LDD: 3605217902139

3605217900876
LDD: 8412081003290

3605217900869
LDD: 8412081003283

6,37 x 4,12 x H. 1,33 m

6,56 x 4,56 x H. 1,31 m

6,20 x 3,95 x H. 1,27 m

5,51 x 3,51 x H. 1,19 m

4,36 x 3,36 x H. 1,19 m

5,90 x 3,65 x H. 1,30 m

6,08 x 4,08 x H. 1,27 m

5,73 x 3,48 x H. 1,24 m

5,03 x 3,03 x H. 1,16 m

4,03 x 3,03 x H. 1,16 m

23 m³

24,7 m³

20,8 m³

14,5 m³

11,2 m³



CUÑA METÁLICA · WEDGE · LE SABOT · CUNEO METALLICO

1,20 m

1,17 m

1,14 m

1,06 m

1,06 m

Pino silvestre francés y autoclave clase IV · Pine boards originating in France, with a class IV autoclave · Pin sylvestre origine France autoclave classe IV · pino silvestre francese con trattamento in autoclave classe IV - Certificado · Certificate · Certifié · Certificato PEFC

Ancho · Width · Largeur · Larghezza: 29 cm, GRENADE: 19cm · Espesor · Thickness · Épaisseur · Dimensione: 2,8 cm
Embellecedores metálicos · Metal covers · Caches angles inox · Protezione metallico inox

46 mm

46 mm

46 mm

46 mm

46 mm

75/100^e uni

75/100^e uni

60/100^e uni

60/100^e uni

60/100^e uni

FILTRO DE ARENA · SAND FILTER · FILTRATION À SABLE · FILTRO A SABBIA

8 m³/h

8 m³/h

6 m³/h

6 m³/h

4 m³/h

Espesor · Thickness · Épaisseur · Dimensione
200 g/m²



ACERO INOXIDABLE · STAINLESS STEEL · ACIER INOXIDABLE · ACCIAIO INOX

MADERA · WOOD · BOIS · LEGNO

Losa de hormigón obligatorio · Obligatory concrete slab · Chape béton Obligatoire · Basamento di calcestruzzo obbligatorio

638 x 463 x H 15 cm
4,43 m³

660 x 520 x H 15 cm
5,14 m³

620 x 450 x H 15 cm
4,18 m³

553 x 403 x H 15 cm
3,34 m³

453 x 403 x H 15 cm
2,74 m³

L 400 x l 120 x H 57 cm
1040 kg
L 80 x l 120 x H 100 cm
210 kg

L 400 x l 114 x H 65 cm
1190 kg
L 80 x l 120 x H 100 cm
250 kg

L 400 x l 114 x H 53 cm
950 kg
L 80 x l 120 x H 85 cm
200 kg

L 350 x l 120 x H 52 cm
800 kg
L 80 x l 120 x H 78 cm
147 kg

L 299 x l 120 x H 48 cm
620 kg
L 80 x l 120 x H 78 cm
133 kg

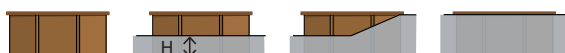

wooden pool **CARDAMON · MINT · ANISE**

H. 1,46



	REFERENCIA RÉFÉRENCE	REFERENCE RIFERIMENTO
	CÓDIGO EAN GENCOD	EAN CODE CODICE A BARRE
	EXTERIORES EXTÉRIEURES	OUTSIDE ESTERNO
	INTERIORES INTÉRIEURES	INSIDE INTERNI
	VOLUMEN DE AGUA VOLUME D'EAU	WATER VOLUME VOLUME DI ACQUA
	ESTRUCTURA STRUCTURE	STRUCTURE STRUTTURA
	LINEA DE AGUA LIGNE D'EAU	WATER LINE LINEA DELL'ACQUA
	ESTRUCTURA STRUCTURE	STRUCTURE STRUTTURA
	PLAYAS MARGELLES	EDGES BORDI
	ESPESOR MADERA ÉPAISEUR MADRIER	WOOD THICKNESS DIMENSIONE
	LINER	
	FILTRACIÓN FILTRATION	FILTRATION FILTRO
	PROTECTOR DE FONDO FEUTRE DE FOND	FLOOR PROTECTOR PROTEZIONE DEL FONDO
	PROTECTOR DE PARED FEUTRE DE PAROI	WALL PROTECTOR COPERTURA DELLA PARETE
	ESCALERA INTERIOR ÉCHELLE INTÉRIEURE	INSIDE LADDER SCALA INTERNA
	ESCALERA EXTERIOR ÉCHELLE EXTÉRIEURE	OUTSIDE LADDER SCALA ESTERNA
	TERRENO SUPPORT	LAND TERRENO
	PALET	
	IMPLANTATION	

CARDAMON



788033

3605217880338

12,18 x 4,27 x H. 1,46 m

11,63 x 3,80 x H. 1,42 m

60 m³

MINT



788032

3605217880321

10,18 x 4,27 x H. 1,46 m

9,63 x 3,80 x H. 1,42 m

50 m³

ANISE



788031

3605217880314

9,18 x 3,27 x H. 1,46 m

8,63 x 2,80 x H. 1,42 m

35 m³



VIGAS METÁLICAS · BURIED STEEL BEAM · LE BERCEAU · BARRA DI ACCIAIO (IPE SYSTEM)

1,36 m

1,36 m

1,36 m

Pino silvestre francés y autoclave clase IV · Pine boards originating in France, with a class IV autoclave · Pin sylvestre origine France autoclave classe IV · pino silvestre francese con trattamento in autoclave classe IV - Certificado · Certificate · Certifié · Certificato PEFC

Ancho · Width · Largeur · Larghezza: 29 cm · Espesor · Thickness · Épaisseur · Dimensione: 3,6 cm
Embellecedores metálicos · Metal covers · Caches angles inox · Protezione metallico inox

46 mm

46 mm

46 mm

75/100^e uni

75/100^e uni

75/100^e uni

FILTRO DE ARENA · SAND FILTER · FILTRATION À SABLE · FILTRO A SABBIA

10 m³/h - 2 skimmer

10 m³/h - 2 skimmer

10 m³/h - 2 skimmer

Espesor · Thickness · Épaisseur · Dimensione
200 g/m²



ACERO INOXIDABLE · STAINLESS STEEL · ACIER INOXIDABLE · ACCIAIO INOX

MADERA · WOOD · BOIS · LEGNO

Losa de hormigón obligatorio · Obligatory concrete slab · Chape béton Obligatoire · Basamento di calcestruzzo obbligatorio

1300 x 500 x H 17 cm
11,05 m³

1100 x 500 x H 17 cm
9,35 m³

1000 x 400 x H 17 cm
6,8 m³

L 400 x l 120 x H 102 cm - 2070 kg
L 80 x l 200 x H 100 cm - 673 kg

L 400 x l 120 x H 92 cm - 1730 kg
L 200 x l 80 x H 100 cm - 612 kg

L 300 x l 120 x H 89 cm - 1600 kg
L 200 x l 80 x H 100 cm - 514 kg



wooden pool BRAGA · EVORA

H. 1,24 - H. 1,33

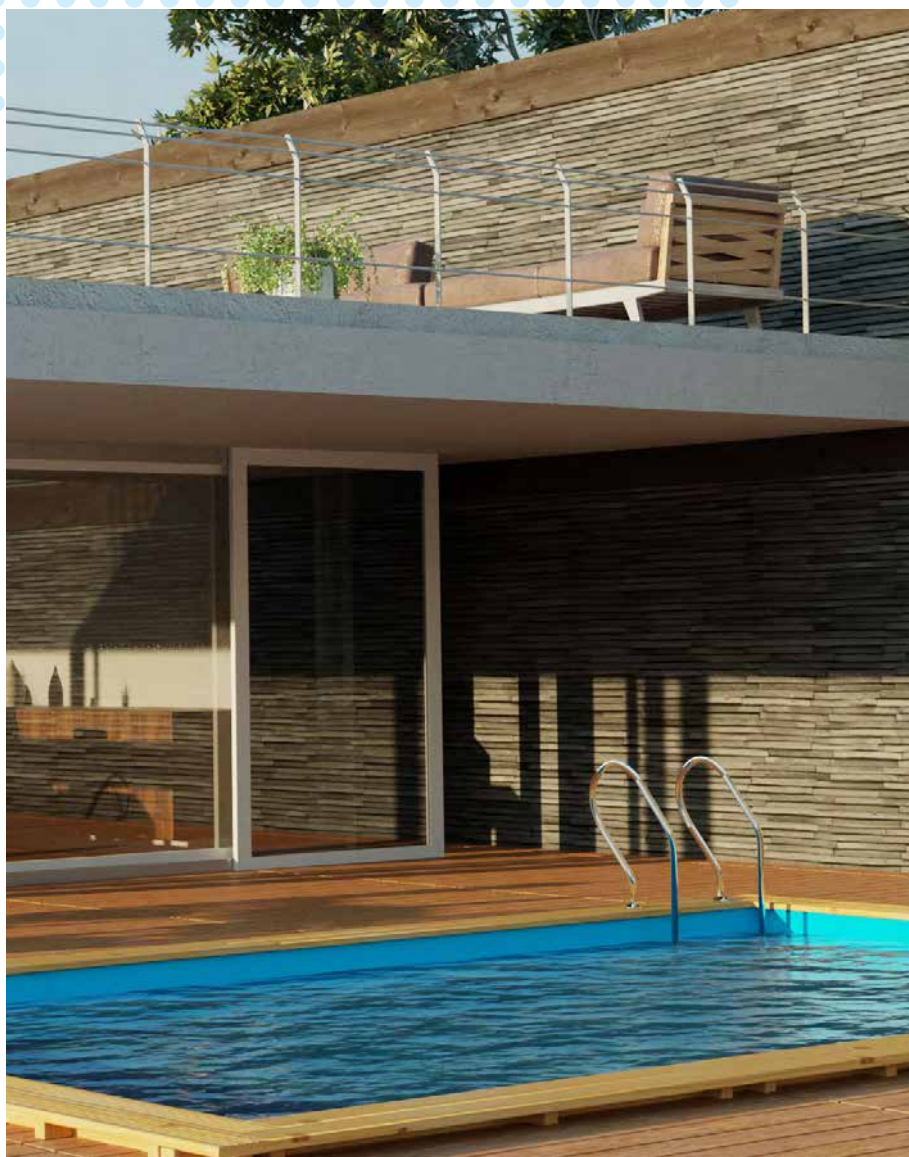

	REFERENCIA RÉFÉRENCE	REFERENCE RIFERIMENTO
	CÓDIGO EAN GENCOD	EAN CODE CODICE A BARRE
	EXTERIORES EXTÉRIEURES	OUTSIDE ESTERNO
	INTERIORES INTÉRIEURES	INSIDE INTERNI
	VOLUMEN DE AGUA VOLUME D'EAU	WATER VOLUME VOLUME DI ACQUA
	ESTRUCTURA STRUCTURE	STRUCTURE STRUTTURA
	LINEA DE AGUA LIGNE D'EAU	WATER LINE LINEA DELL'ACQUA
	ESTRUCTURA STRUCTURE	STRUCTURE STRUTTURA
	PLAYAS MARGELLES	EDGES BORDI
	ESPESOR MADERA ÉPAISEUR MADRIER	WOOD THICKNESS DIMENSIONE
	LINER	
	FILTRACIÓN FILTRATION	FILTRATION FILTRO
	PROTECTOR DE FONDO FEUTRE DE FOND	FLOOR PROTECTOR PROTEZIONE DEL FONDO
	PROTECTOR DE PARED FEUTRE DE PAROI	WALL PROTECTOR COPERTURA DELLA PARETE
	ESCALERA INTERIOR ÉCHELLE INTÉRIEURE	INSIDE LADDER SCALA INTERNA
	ESCALERA EXTERIOR ÉCHELLE EXTÉRIEURE	OUTSIDE LADDER SCALA ESTERNA
	TERRENO SUPPORT	LAND TERRENO
	PALET	
	IMPLANTATION	

BRAGA

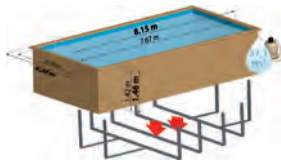

EVORA



790207
LDD: **790207D**

790206
LDD: **790206D**

3605217902078
LDD: 3605217902207

3605217902061
LDD: 3605217902191

8,15 x 4,20 x H. 1,46 m

6,20 x 4,20 x H. 1,33 m

7,67 x 3,73 x H. 1,42 m

5,70 x 3,73 x H. 1,30 m

37 m³

24,1 m³



VIGAS METÁLICAS · BURIED STEEL BEAM · LE BERCEAU · BARRA DI ACCIAIO (IPE SYSTEM)

1,34 m

1,20 m

Pino silvestre francés y autoclave clase IV · Pine boards originating in France, with a class IV autoclave · Pin sylvestre origine France autoclave classe IV · pino silvestre francese con trattamento in autoclave classe IV - Certificado · Certificate · Certifié · Certificato PEFC

Ancho · Width · Largeur · Larghezza: 29 cm · Espesor · Thickness · Épaisseur · Dimensione: 2,8 cm, BRAGA: 3,6 cm
Embellecedores metálicos · Metal covers · Caches angles inox · Protezione metallico inox

46 mm

46 mm

75/100^e uni

75/100^e uni

FILTRO DE ARENA · SAND FILTER · FILTRATION À SABLE · FILTRO A SABBIA

10 m³ /h - 2 skimmer

10 m³/h

Espesor · Thickness · Épaisseur · Dimensione
200 g/m²



ACERO INOXIDABLE · STAINLESS STEEL · ACIER INOXIDABLE · ACCIAIO INOX

MADERA · WOOD · BOIS · LEGNO

Losa de hormigón obligatorio · Obligatory concrete slab
Chape béton Obligatoire · Basamento di calcestruzzo obbligatorio

900 x 500 x H 17 cm
7,65 m³

700 x 500 x H 17 cm
5,95 m³

L 405 x l 111 x H 77 cm - 1540kg
L 200 x l 80 x H 100 cm - 300 kg

L 405 x l 111 x H 62 cm - 1180 kg
L 80 x l 120 x H 100 cm - 400 kg

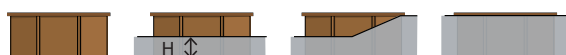

wooden pool MANGO · MARBELLA

H. 1,30 - H. 1,19



	REFERENCIA RÉFÉRENCE	REFERENCE RIFERIMENTO
	CÓDIGO EAN GENCOD	EAN CODE CODICE A BARRE
	EXTERIORES EXTÉRIEURES	OUTSIDE ESTERNO
	INTERIORES INTÉRIEURES	INSIDE INTERNI
	VOLUMEN DE AGUA VOLUME D'EAU	WATER VOLUME VOLUME DI ACQUA
	ESTRUCTURA STRUCTURE	STRUCTURE STRUTTURA
	LINEA DE AGUA LIGNE D'EAU	WATER LINE LINEA DELL'ACQUA
	ESTRUCTURA STRUCTURE	STRUCTURE STRUTTURA
	PLAYAS MARGELLES	EDGES BORDI
	ESPESOR MADERA ÉPAISEUR MADRIER	WOOD THICKNESS DIMENSIONE
	LINER	
	FILTRACIÓN FILTRATION	FILTRATION FILTRO
	PROTECTOR DE FONDO FEUTRE DE FOND	FLOOR PROTECTOR PROTEZIONE DEL FONDO
	PROTECTOR DE PARED FEUTRE DE PAROI	WALL PROTECTOR COPERTURA DELLA PARETE
	ESCALERA INTERIOR ÉCHELLE INTÉRIEURE	INSIDE LADDER SCALA INTERNA
	ESCALERA EXTERIOR ÉCHELLE EXTÉRIEURE	OUTSIDE LADDER SCALA ESTERNA
	TERRENO SUPPORT	LAND TERRENO
	8	
	IMPLANTATION	



MANGO

KPBRC620

8412081273266

6,18 x 3,20 x H. 1,30 m

5,68 x 2,73 x H. 1,27 m

18,1 m³

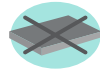

SISTEMA DE OMEGAS - OMEGA SYSTEM
RENFORÇS ENTERRÉS - SISTEMA OMEGA

1,17 m

MARBELLA



790096
LDD: 790096D

3605217900968
LDD: 8412081003382

4,27 x 2,77 x H. 1,19 m

3,79 x 2,29 x H. 1,16 m

9 m³

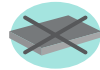

SISTEMA DE OMEGAS - OMEGA SYSTEM
RENFORÇS ENTERRÉS - SISTEMA OMEGA

1,06 m

Pino silvestre francés y autoclave clase IV · Pine boards originating in France, with a class IV autoclave · Pin sylvestre origine France autoclave classe IV · pino silvestre francese con trattamento in autoclave classe IV - Certificado · Certificate · Certifié · Certificato PEFC

Ancho · Width · Largeur · Larghezza: 29 cm · Espesor · Thickness · Épaisseur · Dimensione: 2,8 cm, BRAGA: 3,6 cm
Embellecedores metálicos · Metal covers · Caches angles inox · Protezione metallico inox

46 mm

46 mm

60/100^e uni

75/100^e uni

FILTRO DE ARENA · SAND FILTER · FILTRATION À SABLE · FILTRO A SABBIA

6 m³ /h

4 m³/h

Espeor · Thickness · Épaisseur · Dimensione
200 g/m²



ACERO INOXIDABLE · STAINLESS STEEL · ACIER INOXIDABLE · ACCIAIO INOX

MADERA · WOOD · BOIS · LEGNO

Losa de hormigón opcional · Optional concrete slab · Chape béton facultative · Basamento di calcestruzzo opzionale

690 x 395 x H 15 cm
4,08 m³

500 x 350 x H 15 cm
2,62 m³

L 400 x l 120 x H 58 cm - 1100 kg
L 200 x l 80 x H 78 cm - 346 kg

L 400 x l 120 x H 40 cm - 700 kg
L 80 x l 200 x H 85 cm - 252 kg

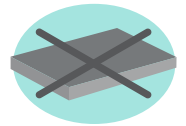
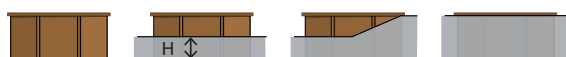

Optional
Opcional
Facultative
Opzionale

wooden pool MACADAMIA · BAMBU

H. 1,30



	REFERENCIA RÉFERENCE	REFERENCE RIFERIMENTO
	CÓDIGO EAN GENCOD	EAN CODE CODICE A BARRE
	EXTERIORES EXTÉRIEURES	OUTSIDE ESTERNO
	INTERIORES INTÉRIEURES	INSIDE INTERNI
	VOLUMEN DE AGUA VOLUME D'EAU	WATER VOLUME VOLUME DI ACQUA
	ESTRUCTURA STRUCTURE	STRUCTURE STRUTTURA
	LINEA DE AGUA LIGNE D'EAU	WATER LINE LINEA DELL'ACQUA
	ESTRUCTURA STRUCTURE	STRUCTURE STRUTTURA
	PLAYAS MARGELLES	EDGES BORDI
	ESPESOR MADERA ÉPAISEUR MADRIER	WOOD THICKNESS DIMENSIONE
	LINER	
	FILTRACIÓN FILTRATION	FILTRATION FILTRO
	PROTECTOR DE FONDO FEUTRE DE FOND	FLOOR PROTECTOR PROTEZIONE DEL FONDO
	PROTECTOR DE PARED FEUTRE DE PAROI	WALL PROTECTOR COPERTURA DELLA PARETE
	ESCALERA INTERIOR ÉCHELLE INTÉRIEURE	INSIDE LADDER SCALA INTERNA
	ESCALERA EXTERIOR ÉCHELLE EXTÉRIEURE	OUTSIDE LADDER SCALA ESTERNA
	TERRENO SUPPORT	LAND TERRENO
	PALET	
	IMPLANTATION	

MACADAMIA

NEW 2020

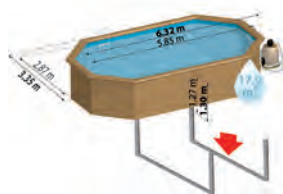

BAMBU

NEW 2020

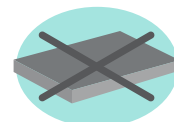

Optional
Opzionale
Facultative

KPBOC632

KPBOC535

8412081273242

8412081273235

6,32 x 3,35 x H. 1,30 m

5,35 x 3,35 x H. 1,30 m

5,85 x 2,87 x H. 1,27 m

4,87 x 2,87x H. 1,27 m

17,9 m³

14,6 m³



SISTEMA DE OMEGAS - OMEGA SYSTEM
RENFORÇS ENTERRÉS - SISTEMA OMEGA

1,17 m

1,17 m

Pino silvestre francés y autoclave clase IV · Pine boards originating in France, with a class IV autoclave · Pin sylvestre origine France autoclave classe IV · pino silvestre francese con trattamento in autoclave classe IV - Certificado · Certificate · Certifié · Certificato PEFC

Ancho · Width · Largeur · Larghezza: 29 cm · Espesor · Thickness · Épaisseur · Dimensione: 2,8 cm
Embellecedores metálicos · Metal covers · Caches angles inox · Protezione metallico inox

46 mm

46 mm

60/100^e uni

60/100^e uni

FILTRO DE ARENA · SAND FILTER · FILTRATION À SABLE · FILTRO A SABBIA

6 m³ /h

6 m³/h

Espesor · Thickness · Épaisseur · Dimensione
200 g/m²



ACERO INOXIDABLE · STAINLESS STEEL · ACIER INOXIDABLE · ACCIAIO INOX

MADERA · WOOD · BOIS · LEGNO

Losa de hormigón opcional · Optional concrete slab · Chape béton facultative · Basamento di calcestruzzo opzionale

705 x 407 x H 15 cm
4,30 m³

605 x 407 x H 15 cm
3,69 m³

L 400 x l 120 x H 54 cm - 990 kg
L 200 x l 80 x H 78 cm - 250 kg

L 355 x l 120 x H 53 cm - 820 kg
L 200 x l 80 x H 78 cm - 167 kg

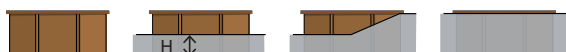

wooden pool CARRA · LEMON · CITY

H. 1,19 - H. 0,68



	REFERENCIA RÉFÉRENCE	REFERENCE RIFERIMENTO
	CÓDIGO EAN GENCOD	EAN CODE CODICE A BARRE
	EXTERIORES EXTÉRIEURES	OUTSIDE ESTERNO
	INTERIORES INTÉRIEURES	INSIDE INTERNI
	VOLUMEN DE AGUA VOLUME D'EAU	WATER VOLUME VOLUME DI ACQUA
	ESTRUCTURA STRUCTURE	STRUCTURE STRUTTURA
	LINEA DE AGUA LIGNE D'EAU	WATER LINE LINEA DELL'ACQUA
	ESTRUCTURA STRUCTURE	STRUCTURE STRUTTURA
	PLAYAS MARGELLES	EDGES BORDI
	ESPESOR MADERA ÉPAISEUR MADRIER	WOOD THICKNESS DIMENSIONE
	LINER	
	FILTRACIÓN FILTRATION	FILTRATION FILTRO
	PROTECTOR DE FONDO FEUTRE DE FOND	FLOOR PROTECTOR PROTEZIONE DEL FONDO
	PROTECTOR DE PARED FEUTRE DE PAROI	WALL PROTECTOR COPERTURA DELLA PARETE
	ESCALERA INTERIOR ÉCHELLE INTÉRIEURE	INSIDE LADDER SCALA INTERNA
	ESCALERA EXTERIOR ÉCHELLE EXTÉRIEURE	OUTSIDE LADDER SCALA ESTERNA
	TERRENO SUPPORT	LAND TERRENO
	PALET	
	IMPLANTATION	

NEW
2020

CARRA



LEMON

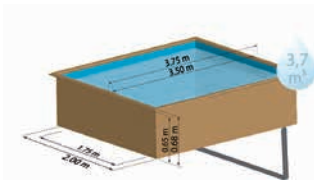

CITY



790205
LDD: **790205D**

790204
LDD: **790204D**

790000
LDD: **790000D**

3605217902054
LDD: 3605217902184

3605217902047
LDD: 3605217902177

3605217900005
LDD: 8412081003474

3,05 x 3,05 x H. 1,19 m

3,75 x 2,00 x H. 0,68 m

2,25 x 2,25 x H. 0,68 m

2,67 x 2,67 x H. 1,16 m

3,50 x 1,75 x H. 0,65 m

2,00 x 2,00 x H. 0,65 m

7,7 m³

3,7 m³

2,3 m³



CUÑA METÁLICA · WEDGE
LE SABOT · CUNEO METALLICO



OMEGA SYSTEM



-

1,06 m

0,6 m

0,6 m

Pino silvestre francés y autoclave clase IV · Pine boards originating in France, with a class IV autoclave · Pin sylvestre origine France autoclave classe IV · pino silvestre francese con trattamento in autoclave classe IV -
Certificado · Certificate · Certifié · Certificato PEFC

Ancho · Width · Largeur · Larghezza: 19 cm
Espesor · Thickness · Épaisseur · Dimensione: 2,8 cm

Ancho · Width · Largeur · Larghezza: 14,5 cm
Espesor · Thickness · Épaisseur · Dimensione: 2,8 cm

46 mm

36 mm

36 mm

60/100^e uni

50/100^e uni

50/100^e uni

FILTRO DE ARENA · SAND FILTER ·
FILTRATION À SABLE · FILTRO A SABBIA
4 m³/h

FILTRO DE CARTUCHO · CARTRIDGE FILTER · EPURATEUR À CARTOUCHE · FILTRO
A CARTUCCIA 2 m³/h

Espeor · Thickness · Épaisseur · Dimensione
200 g/m²

✓

-

-

ACERO INOXIDABLE · STAINLESS STEEL
ACIER INOXIDABLE · ACCIAIO INOX

-

-

MADERA · WOOD · BOIS · LEGNO

-

-

Losa de hormigón obligatorio · Obligatory
concrete slab · Chape béton Obligatoire ·
Basamento di calcestruzzo obbligatorio

Losa de hormigón opcional · Optional concrete slab · Chape béton facultative ·
Basamento di calcestruzzo opzionale

400 x 400 x H 15 cm
2,4 m³

4,75 x 3,00 x H. 15 m
2,13 m³

350 x 350 x H 15 cm
1,8 m³

L 305 x l 111 x H 45 cm - 570 kg
L 80 x l 120 x H 78 cm - 160 kg

L 180 x l 65 x H 59 cm - 325 kg
BOX: L 60 x l 40 x H 80 cm - 40 kg

L 200 x l 120 x H 60 cm - 200 kg
BOX: L 47 x l 30 x H 70 cm - 15 kg

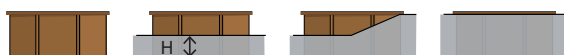

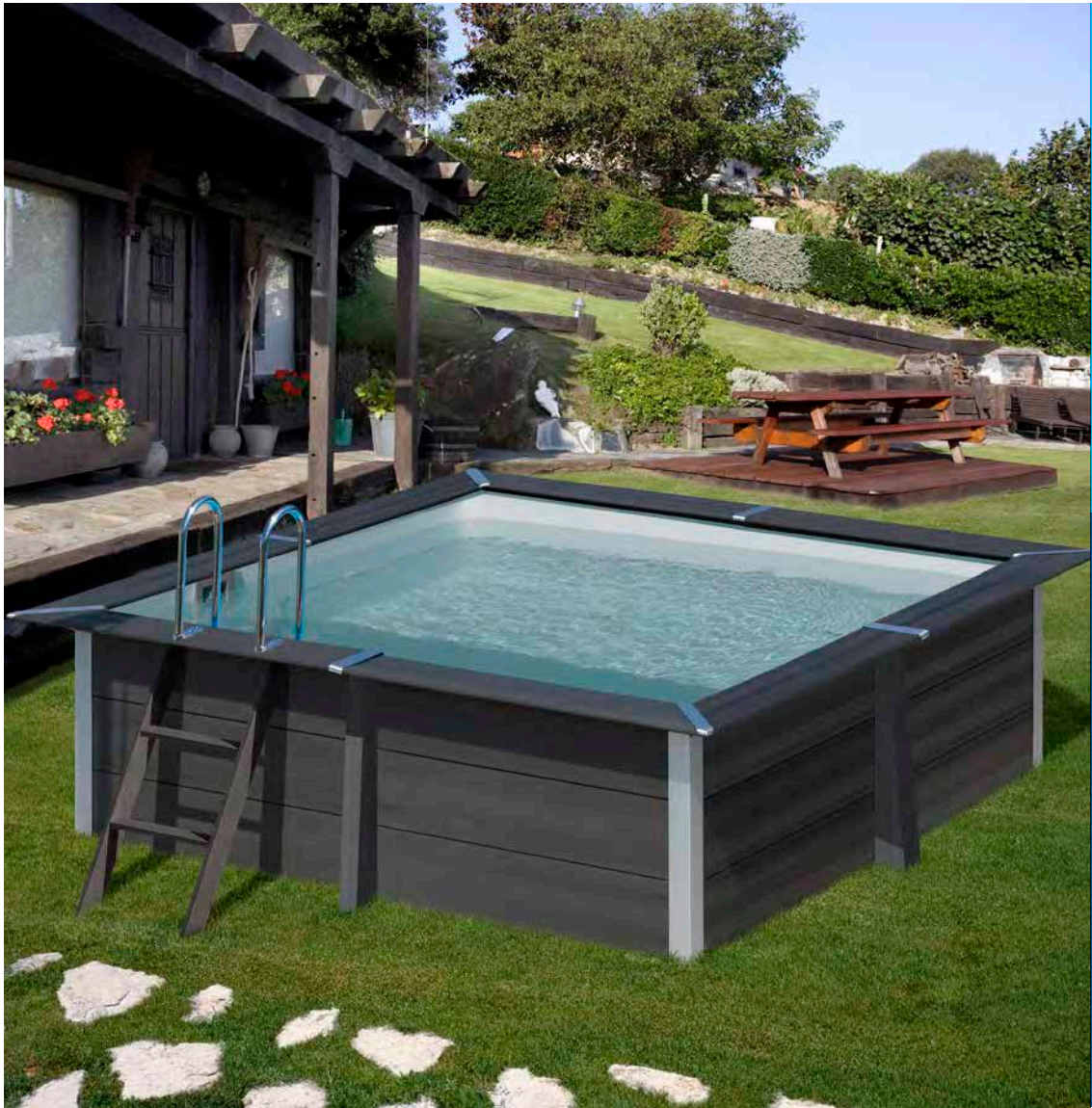

Avantgarde ^{POOLS}



PISCINAS DE COMPOSITE

LINER: Tratamiento Anti-ultravioleta que retrasa el envejecimiento del P.V.C

COMPOSITE: Las piscinas de composite están fabricadas de un nuevo material mezcla de madera (harina de madera) y polímeros.

COMPOSITE POOLS

LINER: Anti-ultraviolet treatment to slow down P.V.C aging.

COMPOSITE: Composite pools are made of a new material mix of wood (wood flour) and polymers.

PISCINES COMPOSITE

LINER: Traitement anti-ultraviolets contre le vieillissement du P.V.C.

COMPOSITE: Les piscines "composite" sont fabriquées avec un nouveau matériau composé d'un mélange de bois (farine de bois) et de polymères.

PISCINA IN COMPOSITE

LINER: Trattamento Anti-ultravioletti - Ritarda l'invecchiamento del P.V.C.

COMPOSITE: Le piscine in composite vengono prodotte con un nuovo materiale composto da una miscela di legno (farina di legno) e polimeri.



Resina plástica
Plastic resin
Résine plastique
Resina plastica

+



Serrín
Sawdust
Farine de bois
Segatura

+



Pigmento
Pigments
Pigments
Pigmenti

+



Aditivos con carga mineral
Mineral additives
Additifs Charge minérale
Additivi con carica minerale

=



DESIGNED &
ASSEMBLED
IN EU

composite pool



KPCOR60



EAN 13

	Dimensions	Depth	Volume	Weight	Box Size	Flow Rate	Safety	Accessories	EAN 13
KPCOR60	606x326 cm	124 cm	17.875 l	1220 kg	1/170x130	6m ³ /h	✓	✓	8 412081 273686
NEW 2020 KPCOR46	466x326 cm	124 cm	13.400 l	1000 kg	1/170x130	4m ³ /h	✓	✓	8 412081 304878
KPCOR28	326x326 cm	96 cm	6.600 l	900 kg	1/170x130	4m ³ /h	✓	✓	8 412081 302683
NEW 2020 KPCOR2814	326x186 cm	96 cm	3.300 l	450 kg	1/170x130	4m ³ /h	✓	✓	8 412081 304953



MEDIDA PISCINA
POOL SIZE
DIMENSIONS PISCINE
MISURA PISCINA

ESPACIO NECESARIO
NECESSARY SPACE
ESPACE NECESSAIRE
SPAZIO NECESSARIO

Model	Dimensions	Required Space
KPCOR60	606x326 cm	806x526 cm
KPCOR46	466x326 cm	666x526 cm
KPCOR28	326x326 cm	526x526 cm
KPCOR2814	326x186 cm	526x386 cm



Liner PVC gris 60/100
PVC grey liner 60/100
Liner PVC gris 60/100
Liner PVC grigio 60/100



Embellecedores de aluminio
Aluminium trims
Protections en aluminium
Profili in alluminio



Perfileria de aluminio
Aluminium profiles
Poteaux et margelles aluminium
Profili in alluminio



La cuña metálica se fija sobre la losa de cemento. Así, es obligatorio realizar la losa, de 15cm de espesor mínimo, previamente al montaje de la piscina.

The wedge is fixed over the concrete slab. In such a way, it is mandatory to make the slab, of 15cm minimum, beforehand to the assembly of the pool.

Le sabot vient se fixer sur la dalle en béton. Il est donc impératif de réaliser une dalle de 15 cm minimum avant le montage du bassin.

Il cuneo metallico si fissa sopra il massetto di cemento. Quindi è obbligatorio realizzare il massetto dello spessore minimo di 15cm prima del montaggio della piscina.



Cuña metálica Metallic wedge Sabots Cuneo metallico



Depuradora arena
(Caudal grupo 6/4 m³/h)
Sand filter
(Flow group 6/4 m³/h)
Filtre à sable
(Débit groupe 6/4 m³/h)
Filtro a sabbia
(Portata gruppo 6/4 m³/h)

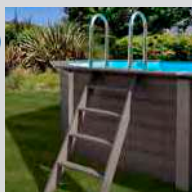

Escalera: Composite /
acero inoxidable
Ladder: Composite /
stainless steel
Échelle: Composite /
acier inoxydable
Scale: Composite /
acciaio inox

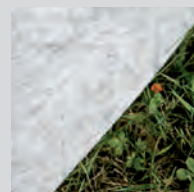

Manta protectora
(Poliéster)
Bottom protective-
blanket (Polyester)
Tapis de sol en feutre
(Polyester)
Telo di protezione
(Poliestere)

composite pool



Vigas enterradas de 15x15 cm que hace innecesarios los postes exteriores, obteniendo mejor aprovechamiento del jardín.

15x15cm buried steel beam makes unnecessary the outer posts, optimizing the use of the garden area.

Poteaux en acier à enterrer de 15x15 cm évitant des renforts apparents extérieurs, pour mieux profiter de l'espace du jardin.

Barra di acciaio interrata da 15x15 cm che non rende necessario l'utilizzo delle barre laterali; permette di poter sfruttare al meglio gli spazi del proprio giardino.

KPCOV52



EAN 13

	804x386 cm	124 cm	27.000 l	1450 kg	1/170x150	6m ³ /h	✓	✓	8 412081 268804
KPCOV80	804x386 cm	124 cm	27.000 l	1450 kg	1/170x150	6m ³ /h	✓	✓	8 412081 268804
KPCOV66	664x386 cm	124 cm	21.500 l	1220 kg	1/170x150	6m ³ /h	✓	✓	8 412081 268798
KPCOV52	524x386 cm	124 cm	16.210 l	960 kg	1/170x130	6m ³ /h	✓	✓	8 412081 268781

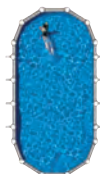

MEDIDA PISCINA
POOL SIZE
DIMENSIONS PISCINE
MISURA PISCINA

ESPACIO NECESARIO
NECESSARY SPACE
ESPACE NECESSAIRE
SPAZIO NECESSARIO

KPCOV80	804x386 cm	844x506 cm
KPCOV66	664x386 cm	704x506 cm
KPCOV52	524x386 cm	564x506 cm



Liner PVC gris 60/100
PVC grey liner 60/100
Liner PVC gris 60/100
Liner PVC grigio 60/100



Embellecedores de aluminio
Aluminium trims
Protections en aluminium
Profili in alluminio

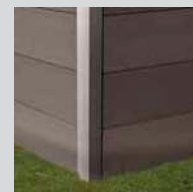

Perfileria de aluminio
Aluminium profiles
Poteaux et margelles aluminium
Profili in alluminio



KPCO41



EAN 13

KPCO41

Ø 410 cm

124 cm

11.000 l

705 kg

1/170x130

4m³/h

✓

✓

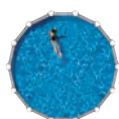

MEDIDA PISCINA
POOL SIZE
DIMENSIONS PISCINE
MISURA PISCINA

ESPACIO NECESARIO
NECESSARY SPACE
ESPACE NECESSAIRE
SPAZIO NECESSARIO

KPCO41

Ø 410cm

450x450 cm



Depuradora arena
(Caudal grupo 6/4 m³/h)
Sand filter
(Flow group 6/4 m³/h)
Filtre à sable
(Débit groupe 6/4 m³/h)
Filtro a sabbia
(Portata gruppo 6/4 m³/h)

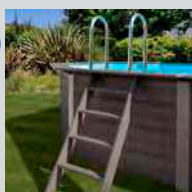

Escalera: Composite /
acero inoxidable
Ladder: Composite /
stainless steel
Échelle: Composite /
acier inoxydable
Scale: Composite /
acciaio inox

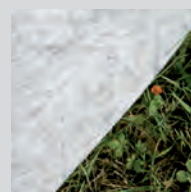

Manta protectora
(Poliéster)
Bottom protective-
blanket (Polyester)
Tapis de sol en feutre
(Polyester)
Telo di protezione
(Poliestere)

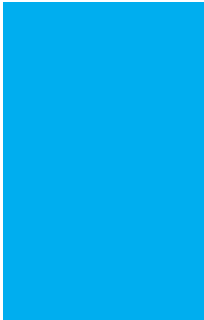



PISCINA DE PARED DE ACERO CON PERFILERÍA DE POLIPROPILENO

LINER: Tratamiento Anti - Ultravioleta que retrasa el envejecimiento del P.V.C.

PARED: laminada en frío con tratamiento de galvanización, fosfatación, imprimación y lacado.

Perfilación vertical de la misma para la obtención de una mayor resistencia.

Troquelada para skimmer y válvula de retorno del agua.

PIEZAS ESTRUCTURALES: De acero.

PERFILES Y PLAYAS: Polipropileno

PISCINES PAROI ACIER AVEC STRUCTURE DE POLYPROPYLENE

LINER: Traitement anti-ultraviolets contre le vieillissement du P.V.C.

PAROI: Tôle laminée à froid et traitée par galvanisation, phosphatage, couche d'apprêt et laquage.

Profils verticaux pour une meilleure résistance.

Découpage pour le skimmer et la buse de refoulement.

PIÈCES STRUCTURELLES: Métalliques

STRUCTURES ET MARGELLES: Polypropylène

STEEL WALL POOL WITH POLYPROPYLENE PROFILES

LINER: Anti-ultraviolet treatment to slow down P.V.C aging.

WALL: Galvanized, phosphatized, primed and lacquered cold-rolled plate .

Vertical sectioning for an increased strength . Die cut for skimmer and water return valve openings.

STRUCTURAL PARTS: Steel

PROFILES AND EDGES: Polypropylene

PISCINA CON PARETI IN ACCIAIO CON PROFILI DI POLIPROPILENE

LINER: Trattamento Anti-ultravioletti - Ritarda l'invecchiamento del P.V.C.

PARETE: Laminata a freddo con trattamento di galvanizzazione, fosfatazione e preparazione.

Preparazione verticale per ottenere una maggiore resistenza.

Stampigliatura per Skimmer e valvola di ritorno dell'acqua.

PEZZI STRUTTURALI: Acciaio.

PROFILI ED PROFILI SUPERIORI: Polipropilene



fusion pool

Viga de acero enterrada 5cm
 Ver manual de instrucciones
 5cm buried steel beam
 See instruction manual
 Poteaux en acier à enterrer 5cm
 Consulter les instructions
 Barra di acciaio interrata 5cm
 Consultare le istruzioni

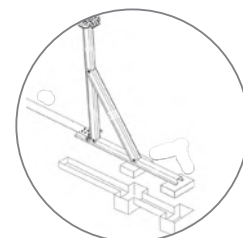

KITPROV760H



EAN 13

KITPROV760H	760x460 cm	135 cm	35.200 l	375 kg	1/120x80	8m ³ /h	√	√	8 412081 273556
KITPROV670H	670x370 cm	135 cm	25.200 l	315 kg	1/120x80	6m ³ /h	√	√	8 412081 273563
KITPROV520H	520x370 cm	135 cm	18.700 l	295 kg	1/120x80	6m ³ /h	√	√	8 412081 273570

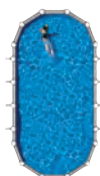

MEDIDA PISCINA
 POOL SIZE
 DIMENSIONS PISCINE
 MISURA PISCINA

ESPACIO NECESARIO
 NECESSARY SPACE
 ESPACE NECESSAIRE
 SPAZIO NECESSARIO

KITPROV760H	760x460 cm	860x660 cm
KITPROV670H	670x370 cm	770x570 cm
KITPROV520H	520x370 cm	620x570 cm



Liner PVC azul 40/100
 PVC blue liner 40/100
 Liner PVC bleu 40/100
 Liner PVC blu 40/100



Embellecedores de Polipropileno
 Polypropylene trims
 Protections en polypropylène
 Profili in polipropilene



Perfilería de Polipropileno
 Polypropylene profiles
 Poteaux et margelles polypropylène
 Profili in polipropilene



KITPR460H



EAN 13

KITPR460H	Ø 460 cm	135 cm	19.200 l	237,5 kg	1/90x80	6m ³ /h	✓	✓	 8 412081 273587
-----------	----------	--------	----------	----------	---------	--------------------	---	---	---------------------

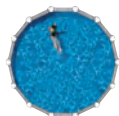

MEDIDA PISCINA
POOL SIZE
DIMENSIONS PISCINE
MISURA PISCINA

ESPACIO NECESARIO
NECESSARY SPACE
ESPACE NECESSAIRE
SPAZIO NECESSARIO

KITPR460H	Ø 460 cm	500x500 cm
-----------	----------	------------



Depuradora arena
(Caudal grupo 8/6 m³/h)
Sand filter
(Flow group 8/6 m³/h)
Filtre à sable
(Débit groupe 8/6 m³/h)
Filtro a sabbia
(Portata gruppo 8/6 m³/h)



Escalera de seguridad
Plataforma
Safety Ladder
Platform
Échelle sécurité
Plateforme
Scala di sicurezza
Piattaforma

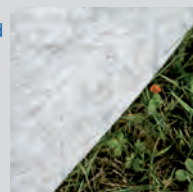

Manta protectora
(Poliéster)
Bottom protective
blanket (Polyester)
Tapis de sol en feutre
(Polyester)
Telo di protezione
(Poliestere)



dream pool



PISCINA DESMONTABLE DE PARED DE ACERO

LINER: Tratamiento Anti - Ultravioleta que retrasa el envejecimiento del P.V.C.

CHAPA: laminada en frío con tratamiento de galvanización, fosfatación, imprimación y lacado.

Perfilación vertical de la misma para la obtención de una mayor resistencia.

Troquelada para skimmer y válvula de retorno del agua.

PIEZAS ESTRUCTURALES: De acero.

STEEL WALL POOL

LINER: Anti-ultraviolet treatment to slow down P.V.C aging.

PLATE: Galvanized, phosphatized, primed and lacquered cold-rolled plate .

Vertical sectioning for an increased strength . Die cut for skimmer and water return valve openings.

STRUCTURAL PARTS: Steel

PISCINES HORS SOL PAROI ACIER

LINER: Traitement anti-ultraviolets contre le vieillissement du P.V.C.

TÔLE: Tôle laminée à froid et traitée par galvanisation, phosphatage, couche d'apprêt et laquage.

Profilés verticaux pour une meilleure résistance.

Découpage pour le skimmer et la buse de refoulement.

PIÈCES STRUCTURELLES: Métalliques

PISCINE FUORI TERRACON PARETI IN ACCIAIO

LINER: Trattamento Anti-ultravioletti - Ritarda l'invecchiamento del P.V.C.

PANNELLO: Laminata a freddo con trattamento di galvanizzazione, fosfatazione e preparazione.

Preparazione verticale per ottenere una maggiore resistenza.

Stampigliatura per Skimmer e valvola di ritorno dell'acqua.

PEZZI STRUTTURALI: Acciaio.

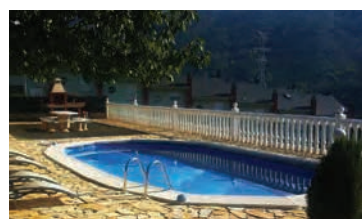

**DESIGNED
MACHINED &
ASSEMBLED
IN EU**

dream pool

serie **CAPRI**



KITPROV7388GF



EAN 13

Model	Dimensions (LxW)	Height	Capacity (l)	Weight (kg)	Box Size (LxW)	Flow Rate (m³/h)	Filter	Ladder	Cover	Liner	Barcode
KITPROV7388GF	730x375 cm	132 cm	28.217 l	348 kg	1/120x80	6m³/h	✓	✓	15	12	8 412081 272382
KITPROV6188GF	610x375 cm	132 cm	23.281 l	279 kg	1/90x80	6m³/h	✓	✓	15	12	8 412081 272399

🇫🇷 Références non disponibles en France

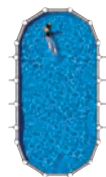

MEDIDA PISCINA
POOL SIZE
DIMENSIONS PISCINE
MISURA PISCINA

ESPACIO NECESARIO
NECESSARY SPACE
ESPACE NECESSAIRE
SPAZIO NECESSARIO

KITPROV7388GF	730x375 cm	770x495 cm
KITPROV6188GF	610x375 cm	650x495 cm

NEW
2020



Liner PVC gris
40/100
PVC grey liner
40/100
Liner PVC gris
40/100
Liner PVC grigio
40/100

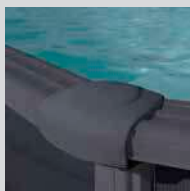

Protectores de
inyección
Injection saver
Protections
moulées par
injection
Angolare di
protezione

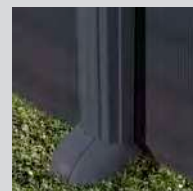

Perfilería de acero
Steel profiles
Poteaux et
margelles acier
Profili in acciaio



Viga de acero enterrada de 15x15 cm que hace innecesarios los postes exteriores, obteniendo mejor aprovechamiento del jardín.

15x15 cm buried steel beam makes unnecessary the outer buttress, optimizing the use of the garden area.

Poteaux en acier à enterrer de 15x15 cm évitant des renforts apparents extérieurs, pour mieux profiter de l'espace du jardin.

Barra di acciaio interrata da 15x15 cm che non rende necessario l'utilizzo delle barre laterali; permette di poter sfruttare al meglio gli spazi del proprio giardino.



Sistema de omegas Omega system Renforts enterrés Sistema omega



Depuradora arena
(Caudal grupo 6 m³/h)
Sand filter
(Flow group 6 m³/h)
Filtre à sable
(Débit groupe 6 m³/h)
Filtro a sabbia
(Portata gruppo 6 m³/h)



Escalera de seguridad
Plataforma
Safety Ladder
Platform
Échelle sécurité
Plateforme
Scala di sicurezza
Piattaforma



Tapiz protector
(Poliétileno)
Floor tapestry
(Polythene)
Tapis de sol en feutre
(Polyéthylène)
Telo di protezione
(Poliétilene)

dream pool

serie **GRANADA**

KITPROV738GF



EAN 13

	730x375 cm	132 cm	28.217 l	335 kg	1/120x80	6m³/h	√	√	15	12	8 412081 272405
KITPROV738GF	730x375 cm	132 cm	28.217 l	335 kg	1/120x80	6m³/h	√	√	15	12	8 412081 272405
KITPROV618GF	610x375 cm	132 cm	23.281 l	270 kg	1/90x80	6m³/h	√	√	15	12	8 412081 272412
KITPROV508GF	500x300 cm	132 cm	16.210 l	260 kg	1/90x80	6m³/h	√	√	15	12	8 412081 272429

🇫🇷 Références non disponibles en France

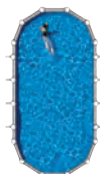
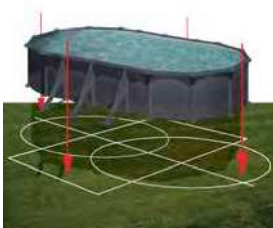

MEDIDA PISCINA
POOL SIZE
DIMENSIONS PISCINE
MISURA PISCINA

ESPACIO NECESARIO
NECESSARY SPACE
ESPACE NECESSAIRE
SPAZIO NECESSARIO

KITPROV738GF	730x375 cm	770x595 cm
KITPROV618GF	610x375 cm	650x595 cm
KITPROV508GF	500x300 cm	540x520 cm

NEW
2020



Liner PVC gris
40/100
PVC grey liner
40/100
Liner PVC gris
40/100
Liner PVC grigio
40/100

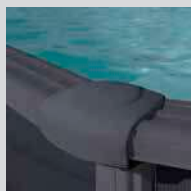

Protectores de
inyección
Injection saver
Protections
moulées par
injection
Angolare di
protezione

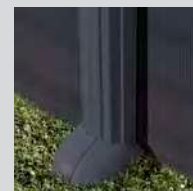

Perfilería de acero
Steel profiles
Poteaux et
margelles acier
Profili in acciaio



KITPR558GF



EAN 13

Model	Ø	Height	Capacity (l)	Weight (kg)	Box Size	Flow (m³/h)	Filter	Ladder	Mat	Cover	EAN 13
KITPR558GF	Ø550 cm	132 cm	27.798 l	243 kg	1/90x80	6m³/h	✓	✓	15	12	8 412081 272436
KITPR458GF	Ø460 cm	132 cm	19.444 l	238 kg	1/90x80	6m³/h	✓	✓	15	12	8 412081 272443
KITPR358GF	Ø350 cm	132 cm	11.250 l	184 kg	1/90x80	6m³/h	✓	✓	15	12	8 412081 272450

🇫🇷 Références non disponibles en France

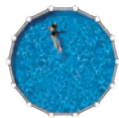

	MEDIDA PISCINA POOL SIZE DIMENSIONS PISCINE MISURA PISCINA	ESPACIO NECESARIO NECESSARY SPACE ESPACE NECESSAIRE SPAZIO NECESSARIO
KITPR558GF	Ø 550cm	600x600 cm
KITPR458GF	Ø 460cm	500x500 cm
KITPR358GF	Ø 350cm	400x400 cm



Depuradora arena
(Caudal grupo 6 m³/h)
Sand filter
(Flow group 6 m³/h)
Filtre à sable
(Débit groupe 6 m³/h)
Filtro a sabbia
(Portata gruppo 6 m³/h)



Escalera de seguridad
Plataforma
Safety Ladder
Platform
Échelle sécurité
Plateforme
Scala di sicurezza
Piattaforma



Tapiz protector
(Polietileno)
Floor tapestry
(Polythene)
Tapis de sol en feutre
(Polyéthylène)
Telo di protezione
(Polietilene)

dream pool

serie KEA

KIT610GF



EAN 13

	730x375 cm	610x375 cm	500x300 cm
KIT730GF	730x375 cm	610x375 cm	500x300 cm
	120 cm	120 cm	120 cm
	25.323 l	20.893 l	14.550 l
	287 kg	235 kg	224 kg
	1/90x80	1/80x60	1/80x60
	4m ³ /h	4m ³ /h	4m ³ /h
	√	√	√
	15	15	15
	12	12	12
	8 4 1 2 0 8 1 2 7 2 4 6 7	8 4 1 2 0 8 1 2 7 2 4 7 4	8 4 1 2 0 8 1 2 7 3 0 8 2

🇫🇷 Références non disponibles en France

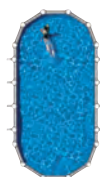

MEDIDA PISCINA
POOL SIZE
DIMENSIONS PISCINE
MISURA PISCINA

ESPACIO NECESARIO
NECESSARY SPACE
ESPACE NECESSAIRE
SPAZIO NECESSARIO

	MEDIDA PISCINA POOL SIZE DIMENSIONS PISCINE MISURA PISCINA	ESPACIO NECESARIO NECESSARY SPACE ESPACE NECESSAIRE SPAZIO NECESSARIO
KIT730GF	730x375 cm	770x595 cm
KIT610GF	610x375 cm	650x595 cm
KIT500GF	500x300 cm	540x520 cm

NEW
2020



Liner PVC gris 30/100
KIT730GF/KIT610GF: 40/100
PVC grey liner 30/100
KIT730GF/KIT610GF: 40/100
Liner PVC gris 30/100
KIT730GF/KIT610GF: 40/100
Liner PVC grigio 30/100
KIT730GF/KIT610GF: 40/100

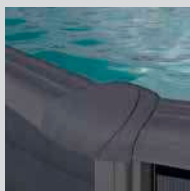

Protectores de inyección
Injection saver
Protections moulées par injection
Angolare di protezione

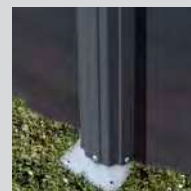

Perfilería de acero
Steel profiles
Poteaux et margelles acier
Profili in acciaio



KIT350GF



EAN 13

Model	Ø	Height	Capacity	Weight	Box Size	Flow	✓	Steps	Mat	Barcode
KIT460GF	Ø460 cm	120 cm	17.450 l	172 kg	1/80x60	4m ³ /h	✓	15	12	8 4 1 2 0 8 1 2 7 2 4 9 8
KIT350GF	Ø350 cm	120 cm	10.102 l	146 kg	1/80x60	4m ³ /h	✓	15	12	8 4 1 2 0 8 1 2 7 2 5 0 4
KIT240GF	Ø240 cm	120 cm	4.750 l	126 kg	1/80x60	4m ³ /h	✓	15	12	8 4 1 2 0 8 1 3 0 2 7 2 0

🇫🇷 Références non disponibles en France

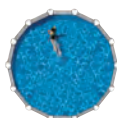

	MEDIDA PISCINA POOL SIZE DIMENSIONS PISCINE MISURA PISCINA	ESPACIO NECESARIO NECESSARY SPACE ESPACE NECESSAIRE SPAZIO NECESSARIO
KIT460GF	Ø 460cm	500x500 cm
KIT350GF	Ø 350cm	400x400 cm
KIT240GF	Ø 240cm	300x300 cm



Depuradora arena
(Caudal grupo 4 m³/h)
Sand filter
(Flow group 4 m³/h)
Filtre à sable
(Débit groupe 4 m³/h)
Filtro a sabbia
(Portata gruppo 4m³/h)



Escalera de seguridad
Plataforma
Safety Ladder
Platform
Échelle sécurité
Plateforme
Scala di sicurezza
Piattaforma



Tapiz protector
(Polietileno)
Floor tapestry
(Polythene)
Tapis de sol en feutre
(Polyéthylène)
Telo di protezione
(Polietilene)

dream pool



serie **SANTORINI**



KITPROV7388PO



EAN 13

KITPROV7388PO	730x375 cm	132 cm	28.217 l	348 kg	1/120x80	6m ³ /h	√	√	15	12	
KITPROV6188PO	610x375 cm	132 cm	23.281 l	279 kg	1/90x80	6m ³ /h	√	√	15	12	

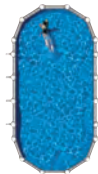
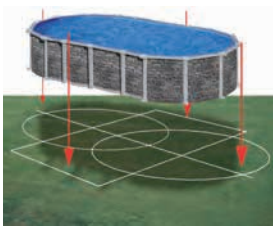

MEDIDA PISCINA
POOL SIZE
DIMENSIONS PISCINE
MISURA PISCINA

ESPACIO NECESARIO
NECESSARY SPACE
ESPACE NECESSAIRE
SPAZIO NECESSARIO

KITPROV7388P	730x375 cm	770x495 cm
KITPROV6188P	610x375 cm	650x495 cm



Liner PVC azul
40/100
PVC blue liner
40/100
Liner PVC bleu
40/100
Liner PVC blu
40/100



Protectores de
inyección
Injection saver
Protections
moulées par
injection
Angolare di
protezione



Perfilería de acero
Steel profiles
Poteaux et
margelles acier
Profili in acciaio



Viga de acero enterrada de 15x15 cm que hace innecesarios los postes exteriores, obteniendo mejor aprovechamiento del jardín.

15x15 cm buried steel beam makes unnecessary the outer buttress, optimizing the use of the garden area.

Poteaux en acier à enterrer de 15x15 cm évitant des renforts apparents extérieurs, pour mieux profiter de l'espace du jardin.

Barra di acciaio interrata da 15x15 cm che non rende necessario l'utilizzo delle barre laterali; permette di poter sfruttare al meglio gli spazi del proprio giardino.



Sistema de omegas Omega system Renforts enterrés Sistema omega



Depuradora arena
(Caudal grupo 6 m³/h)
Sand filter
(Flow group 6 m³/h)
Filtre à sable
(Débit groupe 6 m³/h)
Filtro a sabbia
(Portata gruppo 6 m³/h)



Escalera de seguridad
Plataforma
Safety Ladder
Platform
Échelle sécurité
Plateforme
Scala di sicurezza
Piattaforma



Tapiz protector
(Polietileno)
Floor tapestry
(Polythene)
Tapis de sol en feutre
(Polyéthylène)
Telo di protezione
(Polietilene)

dream pool

serie **CÓRCEGA**



KITPROV618PO



EAN 13

	730x375 cm	610x375 cm	500x300 cm
KITPROV738PO	730x375 cm	610x375 cm	500x300 cm
	132 cm	132 cm	132 cm
	28.217 l	23.281 l	16.210 l
	335 kg	270 kg	260 kg
	1/120x80	1/90x80	1/90x80
	6m ³ /h	6m ³ /h	6m ³ /h
	√	√	√
	√	√	√
	15	15	15
	12	12	12
	8 412081 264516	8 412081 264523	8 412081 264547

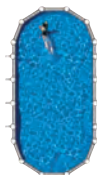

MEDIDA PISCINA
POOL SIZE
DIMENSIONS PISCINE
MISURA PISCINA

ESPACIO NECESARIO
NECESSARY SPACE
ESPACE NECESSAIRE
SPAZIO NECESSARIO

	MEDIDA PISCINA POOL SIZE DIMENSIONS PISCINE MISURA PISCINA	ESPACIO NECESARIO NECESSARY SPACE ESPACE NECESSAIRE SPAZIO NECESSARIO
KITPROV738PO	730x375 cm	770x595 cm
KITPROV618PO	610x375 cm	650x595 cm
KITPROV508PO	500x300 cm	540x520 cm



Liner PVC azul
40/100
PVC blue liner
40/100
Liner PVC bleu
40/100
Liner PVC blu
40/100



Protectores de
inyección
Injection saver
Protections
moulées par
injection
Angolare di
protezione



Perfilería de acero
Steel profiles
Poteaux et
margelles acier
Profili in acciaio



KITPR558PO



EAN 13

Model	Ø	Height	Capacity (l)	Weight (kg)	Box Size	Flow (m³/h)	Filter	Ladder	Cover	Liner	Barcode
KITPR558PO	Ø550 cm	132 cm	27.798 l	243 kg	1/90x80	6m³/h	✓	✓	15	12	8 412081 264530
KITPR458PO	Ø460 cm	132 cm	19.444 l	238 kg	1/90x80	6m³/h	✓	✓	15	12	8 412081 264554
KITPR358PO	Ø350 cm	132 cm	11.250 l	184 kg	1/90x80	6m³/h	✓	✓	15	12	8 412081 264561

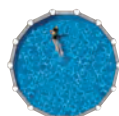

MEDIDA PISCINA
POOL SIZE
DIMENSIONS PISCINE
MISURA PISCINA

ESPACIO NECESARIO
NECESSARY SPACE
ESPACE NECESSAIRE
SPAZIO NECESSARIO

Model	Pool Size	Necessary Space
KITPR558PO	Ø 550cm	600x600 cm
KITPR458PO	Ø 460cm	500x500 cm
KITPR358PO	Ø 350cm	400x400 cm



Depuradora arena
(Caudal grupo 6 m³/h)
Sand filter
(Flow group 6 m³/h)
Filtre à sable
(Débit groupe 6 m³/h)
Filtro a sabbia
(Portata gruppo 6 m³/h)



Escalera de seguridad
Plataforma
Safety Ladder
Platform
Échelle sécurité
Plateforme
Scala di sicurezza
Piattaforma



Tapiz protector
(Polietileno)
Floor tapestry
(Polythene)
Tapis de sol en feutre
(Polyéthylène)
Telo di protezione
(Polietilene)

dream pool

serie **CERDEÑA**



KIT610PO



EAN 13

	730x375 cm	610x375 cm	500x300 cm
KIT730PO	730x375 cm	610x375 cm	500x300 cm
	120 cm	120 cm	120 cm
	25.323 l	20.893 l	14.550 l
	287 kg	235 kg	224 kg
	1/90x80	1/80x60	1/80x60
	4m ³ /h	4m ³ /h	4m ³ /h
	√	√	√
	15	15	15
	12	12	12
	8 4 1 2 0 8 1 2 6 4 5 7 8	8 4 1 2 0 8 1 2 6 4 5 8 5	8 4 1 2 0 8 1 2 6 4 5 9 2

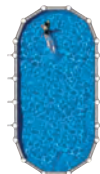
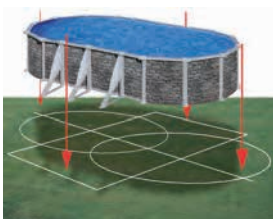

MEDIDA PISCINA
POOL SIZE
DIMENSIONS PISCINE
MISURA PISCINA

ESPACIO NECESARIO
NECESSARY SPACE
ESPACE NECESSAIRE
SPAZIO NECESSARIO

KIT730PO	730x375 cm	770x595 cm
KIT610PO	610x375 cm	650x595 cm
KIT500PO	500x300 cm	540x520 cm



Liner PVC azul 30/100
KIT730P/KIT610P: 40/100
PVC blue liner 30/100
KIT730P/KIT610P: 40/100
Liner PVC bleu 30/100
KIT730P/KIT610P: 40/100
Liner PVC blu 30/100
KIT730P/KIT610P: 40/100



Protectores de inyección
Injection saver
Protections moulées par injection
Angolare di protezione

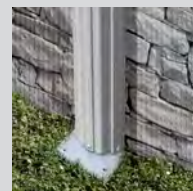

Perfilería de acero
Steel profiles
Poteaux et margelles acier
Profili in acciaio



KIT350PO



EAN 13

	Ø	Height	Capacity (l)	Weight (kg)	Box Size	Flow (m³/h)	✓	Platform	Ladder	Filter	Barcode
KIT460PO	Ø460 cm	120 cm	17.450 l	172 kg	1/80x60	4m³/h	✓	15	12	8 412081 264608	
KIT350PO	Ø350 cm	120 cm	10.102 l	146 kg	1/80x60	4m³/h	✓	15	12	8 412081 264615	
KIT240PO	Ø240 cm	120 cm	4.750 l	126 kg	1/80x60	4m³/h	✓	15	12	8 412081 264622	

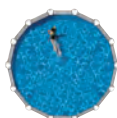

MEDIDA PISCINA
POOL SIZE
DIMENSIONS PISCINE
MISURA PISCINA

ESPACIO NECESARIO
NECESSARY SPACE
ESPACE NECESSAIRE
SPAZIO NECESSARIO

	Pool Diameter	Necessary Space
KIT460PO	Ø 460cm	500x500 cm
KIT350PO	Ø 350cm	400x400 cm
KIT240PO	Ø 240cm	300x300 cm



Depuradora arena
(Caudal grupo 4 m³/h)
Sand filter
(Flow group 4 m³/h)
Filtre à sable
(Débit groupe 4 m³/h)
Filtro a sabbia
(Portata gruppo 4 m³/h)



Escalera de seguridad
Plataforma
Safety Ladder
Platform
Échelle sécurité
Plateforme
Scala di sicurezza
Piattaforma

dream pool

serie **AMAZONIA**



KITPROV6188WO



EAN 13

Model	Dimensions (LxW)	Height	Capacity (l)	Weight (kg)	Box Size (LxW)	Flow Rate (m³/h)	Filter	Ladder	Accessories	Accessories	Accessories	Barcode
KITPROV7388WO	730x375 cm	132 cm	28.217 l	348 kg	1/120x80	6m³/h	✓	✓	15	12	8 412081 257334	
KITPROV6188WO	610x375 cm	132 cm	23.281 l	279 kg	1/90x80	6m³/h	✓	✓	15	12	8 412081 257341	

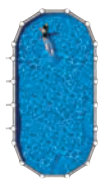

	MEDIDA PISCINA POOL SIZE DIMENSIONS PISCINE MISURA PISCINA	ESPACIO NECESARIO NECESSARY SPACE ESPACE NECESSAIRE SPAZIO NECESSARIO
KITPROV7388WO	730x375 cm	770x495 cm
KITPROV6188WO	610x375 cm	650x495 cm



Liner PVC azul
40/100
PVC blue liner
40/100
Liner PVC bleu
40/100
Liner PVC blu
40/100



Protectores de
inyección
Injection saver
Protections
moulées par
injection
Angolare di
protezione

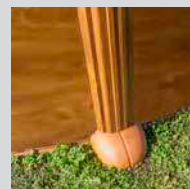

Perfilería de acero
Steel profiles
Poteaux et
margelles acier
Profili in acciaio

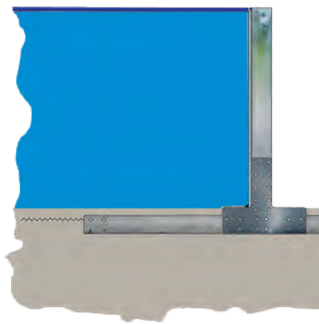

Viga de acero enterrada de 15x15 cm que hace innecesarios los postes exteriores, obteniendo mejor aprovechamiento del jardín.

15x15 cm buried steel beam makes unnecessary the outer buttress, optimizing the use of the garden area.

Poteaux en acier à enterrer de 15x15 cm évitant des renforts apparents extérieurs, pour mieux profiter de l'espace du jardin.

Barra di acciaio interrata da 15x15 cm che non rende necessario l'utilizzo delle barre laterali; permette di poter sfruttare al meglio gli spazi del proprio giardino.



Sistema de omegas Omega system Renforts enterrés Sistema omega



Depuradora arena
(Caudal grupo 6 m³/h)
Sand filter
(Flow group 6 m³/h)
Filtre à sable
(Débit groupe 6 m³/h)
Filtro a sabbia
(Portata gruppo 6)m³/h



Escalera de seguridad
Plataforma
Safety Ladder
Platform
Échelle sécurité
Plateforme
Scala di sicurezza
Piattaforma



Tapiz protector
(Polietileno)
Floor tapestry
(Polythene)
Tapis de sol en feutre
(Polyéthylène)
Telo di protezione
(Polietilene)

dream pool

serie **MAURITIUS**



KITPROV738WO



EAN 13

Model	Dimensions (LxW)	Depth	Volume	Weight	Box Size	Flow Rate	Filter	Ladder	Cover	Accessories	Barcode
KITPROV738WO	730x375 cm	132 cm	28.217 l	335 kg	1/120x80	6m³/h	✓	✓	15	12	8 412081 257358
KITPROV618WO	610x375 cm	132 cm	23.281 l	270 kg	1/90x80	6m³/h	✓	✓	15	12	8 412081 257365
KITPROV508WO	500x300 cm	132 cm	16.210 l	260 kg	1/90x80	6m³/h	✓	✓	15	12	8 412081 258089

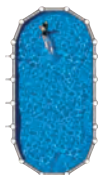

MEDIDA PISCINA
POOL SIZE
DIMENSIONS PISCINE
MISURA PISCINA

ESPACIO NECESARIO
NECESSARY SPACE
ESPACE NECESSAIRE
SPAZIO NECESSARIO

Model	Pool Size	Necessary Space
KITPROV738WO	730x375 cm	770x595 cm
KITPROV618WO	610x375 cm	650x595 cm
KITPROV508WO	500x300 cm	540x520 cm



Liner PVC azul
40/100
PVC blue liner
40/100
Liner PVC bleu
40/100
Liner PVC blu
40/100



Protectores de
inyección
Injection saver
Protections
moulées par
injection
Angolare di
protezione

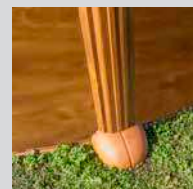

Perfilería de acero
Steel profiles
Poteaux et
margelles acier
Profili in acciaio



KITPR558WO



EAN 13

	Ø	Height	Capacity (l)	Weight (kg)	Box Size	Flow (m³/h)	✓	✓	15	12	Barcode
KITPR558WO	Ø550 cm	132 cm	27.798 l	243 kg	1/90x80	6m³/h	✓	✓	15	12	8 412081 257372
KITPR458WO	Ø460 cm	132 cm	19.444 l	238 kg	1/90x80	6m³/h	✓	✓	15	12	8 412081 257389
KITPR358WO	Ø350 cm	132 cm	11.250 l	184 kg	1/90x80	6m³/h	✓	✓	15	12	8 412081 257396

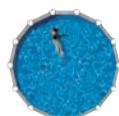

MEDIDA PISCINA
POOL SIZE
DIMENSIONS PISCINE
MISURA PISCINA

ESPACIO NECESARIO
NECESSARY SPACE
ESPACE NECESSAIRE
SPAZIO NECESSARIO

KITPR558WO	Ø 550cm	600x600 cm
KITPR458WO	Ø 460cm	500x500 cm
KITPR358WO	Ø 350cm	400x400 cm



Depuradora arena
(Caudal grupo 6 m³/h)
Sand filter
(Flow group 6 m³/h)
Filtre à sable
(Débit groupe 6 m³/h)
Filtro a sabbia
(Portata gruppo 6)m³/h



Escalera de seguridad
Plataforma
Safety Ladder
Platform
Échelle sécurité
Plateforme
Scala di sicurezza
Piattaforma



Tapiz protector
(Polietileno)
Floor tapestry
(Polythene)
Tapis de sol en feutre
(Polyéthylène)
Telo di protezione
(Polietilene)

dream pool

serie **PACIFIC**



KIT730WO



EAN 13

KIT730W	730x375 cm	120 cm	25.323 l	287 kg	1/90x80	4m ³ /h	√	15	12	8 4 1 2 0 8 1 2 3 2 2 4 9
KIT610W	610x375 cm	120 cm	20.893 l	235 kg	1/80x60	4m ³ /h	√	15	12	8 4 1 2 0 8 1 2 2 5 1 0 4
KIT500W	500x300 cm	120 cm	14.550 l	224 kg	1/80x60	4m ³ /h	√	15	12	8 4 1 2 0 8 1 2 3 1 0 6 8

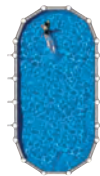

MEDIDA PISCINA
POOL SIZE
DIMENSIONS PISCINE
MISURA PISCINA

ESPACIO NECESARIO
NECESSARY SPACE
ESPACE NECESSAIRE
SPAZIO NECESSARIO

KIT730W	730x375 cm	770x595 cm
KIT610W	610x375 cm	650x595 cm
KIT500W	500x300 cm	540x520 cm



Liner PVC azul 30/100
KIT730W/KIT610W: 40/100
PVC blue liner 30/100
KIT730W/KIT610W: 40/100
Liner PVC bleu 30/100
KIT730W/KIT610W: 40/100
Liner PVC blu 30/100
KIT730W/KIT610W: 40/100



Protectores de inyección
Injection saver
Protections moulées par injection
Angolare di protezione

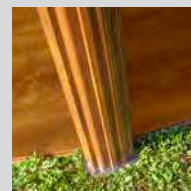

Perfilería de acero
Steel profiles
Poteaux et margelles acier
Profili in acciaio



KIT460WO



EAN 13

	Ø	H	V	P	Paquete	Filtración	✓	Escalera	Plataforma	Barcode
KIT460W	Ø460 cm	120 cm	17.450 l	172 kg	1/80x60	4m³/h	✓	15	12	8 4 12081 225111
KIT350W	Ø350 cm	120 cm	10.102 l	146 kg	1/80x60	4m³/h	✓	15	12	8 4 12081 225722
KIT240W	Ø240 cm	120 cm	4.750 l	126 kg	1/80x60	4m³/h	✓	15	12	8 4 12081 226163

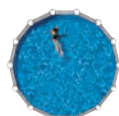

MEDIDA PISCINA
POOL SIZE
DIMENSIONS PISCINE
MISURA PISCINA

ESPACIO NECESARIO
NECESSARY SPACE
ESPACE NECESSAIRE
SPAZIO NECESSARIO

	MEDIDA PISCINA	ESPACIO NECESARIO
KIT460W	Ø 460cm	500x500 cm
KIT350W	Ø 350cm	400x400 cm
KIT240W	Ø 240cm	300x300 cm



Depuradora arena
(Caudal grupo 4 m³/h)
Sand filter
(Flow group 4 m³/h)
Filtre à sable
(Débit groupe 4 m³/h)
Filtro a sabbia
(Portata gruppo 4 m³/h)



Escalera de seguridad
Plataforma
Safety Ladder
Platform
Échelle sécurité
Plateforme
Scala di sicurezza
Piattaforma

dream pool

serie **SICILIA**



KITPROV503W



EAN 13

KITPROV503W

500x300 cm

120 cm

14.550 l

205 kg

1/80x60

3,8m³/h

✓

15

12

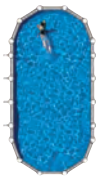

MEDIDA PISCINA
POOL SIZE
DIMENSIONS PISCINE
MISURA PISCINA

ESPACIO NECESARIO
NECESSARY SPACE
ESPACE NECESSAIRE
SPAZIO NECESSARIO

KITPROV503W

500x300 cm

540x520 cm



Liner PVC azul
30/100
PVC blue liner
30/100
Liner PVC bleu
30/100
Liner PVC blu
30/100



Protectores de
inyección
Injection saver
Protections
moulées par
injection
Angolare di
protezione

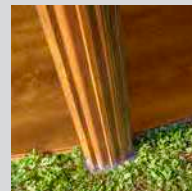

Perfilería de acero
Steel profiles
Poteaux et
margelles acier
Profili in acciaio



KITPR453W



EAN 13

	Ø	H	Capacidad	Peso	Paquete	Filtración	Escalera	Plataforma	Altura	Anchura	Barcode
KITPR453W	Ø460 cm	120 cm	17.450 l	149 kg	3/120x80	3,8m³/h	✓	15	12	8 4 1 2 0 8 1 2 5 8 1 7 1	
KITPR353W	Ø350 cm	120 cm	10.102 l	109 kg	3/120x80	3,8m³/h	✓	15	12	8 4 1 2 0 8 1 2 5 8 1 8 8	
KITPR303W	Ø300 cm	120 cm	7.418 l	94 kg	3/120x80	3,8m³/h	✓	15	12	8 4 1 2 0 8 1 2 6 5 0 8 7	

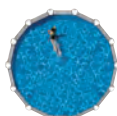

MEDIDA PISCINA
POOL SIZE
DIMENSIONS PISCINE
MISURA PISCINA

ESPACIO NECESARIO
NECESSARY SPACE
ESPACE NECESSAIRE
SPAZIO NECESSARIO

Modelo	Medida Piscina	Espacio Necesario
KITPR453W	Ø 460cm	500x500 cm
KITPR353W	Ø 350cm	400x400 cm
KITPR303W	Ø 300cm	350x350 cm



Filtro de cartucho
(3,8 m³/h)
Cartidge filter
(3,8 m³/h)
Filtre à cartouche
(3,8 m³/h)
Filtro a cartuccia
(3,8 m³/h)



Escalera de seguridad
Plataforma
Safety Ladder
Platform
Échelle sécurité
Plateforme
Scala di sicurezza
Piattaforma

dream pool

serie **HAITI**



KITPROV9188



EAN 13

Model	Dimensions (cm)	Depth (cm)	Volume (l)	Weight (kg)	Box Size (cm)	Flow Rate (m³/h)	Filter	Ladder	Accessories	Accessories	Accessories	Accessories	Accessories
KITPROV10288	1000x550	132	56.111	681	1/120x100	10	√	√	15	12	8 412081 224626		
KITPROV9188	915x470	132	43.595	570	1/120x80	8	√	√	15	12	8 412081 220215		
KITPROV8188	800x470	132	37.474	474	1/120x80	8	√	√	15	12	8 412081 224633		
KITPROV7388	730x375	132	28.217	348	1/120x80	6	√	√	15	12	8 412081 220222		
KITPROV6188	610x375	132	23.281	279	1/90x80	6	√	√	15	12	8 412081 221328		

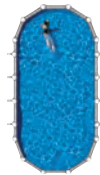
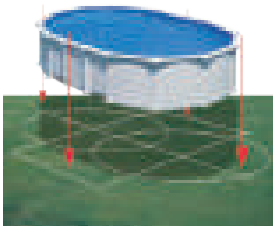

MEDIDA PISCINA
POOL SIZE
DIMENSIONS PISCINE
MISURA PISCINA

ESPACIO NECESARIO
NECESSARY SPACE
ESPACE NECESSAIRE
SPAZIO NECESSARIO

Model	Dimensions (cm)	Required Space (cm)
KITPROV10288	1000x550	1040x670
KITPROV9188	915x470	955x590
KITPROV8188	800x470	850x590
KITPROV7388	730x375	770x495
KITPROV6188	610x375	650x495



Liner PVC azul
40/100
PVC blue liner
40/100
Liner PVC bleu
40/100
Liner PVC blu
40/100



Protectores de
inyección
Injection saver
Protections
moulées par
injection
Angolare di
protezione



Perfilería de acero
Steel profiles
Poteaux et
margelles acier
Profili in acciaio

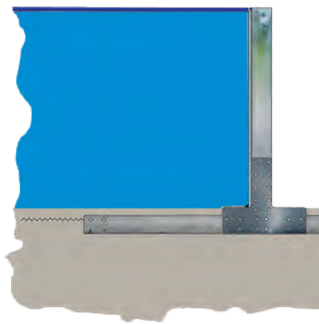

Viga de acero enterrada de 15x15 cm que hace innecesarios los postes exteriores, obteniendo mejor aprovechamiento del jardín.

15x15 cm buried steel beam makes unnecessary the outer buttress, optimizing the use of the garden area.

Poteaux en acier à enterrer de 15x15 cm évitant des renforts apparents extérieurs, pour mieux profiter de l'espace du jardin.

Barra di acciaio interrata da 15x15 cm che non rende necessario l'utilizzo delle barre laterali; permette di poter sfruttare al meglio gli spazi del proprio giardino.



Sistema de omegas Omega system Renforts enterrés Sistema omega



Depuradora arena
(Caudal grupo 10/8/6 m³/h)
Sand filter
(Flow group 10/8/6 m³/h)
Filtre à sable
(Débit groupe 10/8/6 m³/h)
Filtro a sabbia
(Portata gruppo 10/8/6m³/h)



Escalera de seguridad
Plataforma
Safety Ladder
Platform
Échelle sécurité
Plateforme
Scala di sicurezza
Piattaforma



Tapiz protector
(Poliétileno)
Floor tapestry
(Polythene)
Tapis de sol en feutre
(Polyéthylène)
Telo di protezione
(Poliétilene)

dream pool

serie **ATLANTIS**



KITPROV918



EAN 13

Model	Dimensions (cm)	Height (cm)	Capacity (l)	Weight (kg)	Filter (cm)	Flow (m³/h)	✓	✓	15	12	Barcode
KITPROV1028	1000x550	132	56.111	482	1/120x100	10	✓	✓	15	12	8 412081 220239
KITPROV918	915x470	132	43.595	466	1/120x80	8	✓	✓	15	12	8 412081 211978
KITPROV818	800x470	132	37.474	415	1/120x80	8	✓	✓	15	12	8 412081 211565
KITPROV738	730x375	132	28.217	348	1/120x80	6	✓	✓	15	12	8 412081 211985
KITPROV618	610x375	132	23.281	279	1/90x80	6	✓	✓	15	12	8 412081 211572
KITPROV508	500x300	132	16.210	260	1/90x80	6	✓	✓	15	12	8 412081 258119

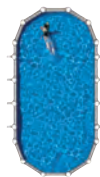
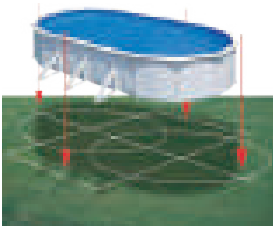

MEDIDA PISCINA
POOL SIZE
DIMENSIONS PISCINE
MISURA PISCINA

ESPACIO NECESARIO
NECESSARY SPACE
ESPACE NECESSAIRE
SPAZIO NECESSARIO

Model	Pool Size (cm)	Necessary Space (cm)
KITPROV1028	1000x550	1040x770
KITPROV918	915x470	955x690
KITPROV818	800x470	850x690
KITPROV738	730x375	770x595
KITPROV618	610x375	650x595
KITPROV508	500x300	540x520



Liner PVC azul
40/100
PVC blue liner
40/100
Liner PVC bleu
40/100
Liner PVC blu
40/100



Protectores de
inyección
Injection saver
Protections
moulées par
injection
Angolare di
protezione



Perfilería de acero
Steel profiles
Poteaux et
margelles acier
Profili in acciaio



KITPR558



EAN 13

Model	Ø	Height	Volume	Weight	Box	Pump	Ladder	Filter	Cover	Accessories	Barcode
KITPR558	Ø550 cm	132 cm	27.798 l	243 kg	1/90x80	6m³/h	✓	✓	15	12	8 412081 211589
KITPR458	Ø460 cm	132 cm	19.444 l	238 kg	1/90x80	6m³/h	✓	✓	15	12	8 412081 211596
KITPR358	Ø350 cm	132 cm	11.250 l	184 kg	1/90x80	6m³/h	✓	✓	15	12	8 412081 233864

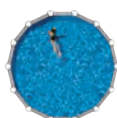

MEDIDA PISCINA
POOL SIZE
DIMENSIONS PISCINE
MISURA PISCINA

ESPACIO NECESARIO
NECESSARY SPACE
ESPACE NECESSAIRE
SPAZIO NECESSARIO

Model	Pool Diameter	Required Space
KITPR558	Ø 550cm	600x600 cm
KITPR458	Ø 460cm	500x500 cm
KITPR358	Ø 350cm	400x400 cm



Depuradora arena
(Caudal grupo 10/8/6 m³/h)
Sand filter
(Flow group 10/8/6 m³/h)
Filtre à sable
(Débit groupe 10/8/6 m³/h)
Filtro a sabbia
(Portata gruppo 10/8/6m³/h)



Escalera de seguridad
Plataforma
Safety Ladder
Platform
Échelle sécurité
Plateforme
Scala di sicurezza
Piattaforma



Tapiz protector
(Poliétileno)
Floor tapestry
(Polythene)
Tapis de sol en feutre
(Polyéthylène)
Telo di protezione
(Poliétilene)

dream pool

serie **FIDJI**



KIT730ECO



EAN 13

Model	Dimensions (cm)	Height (cm)	Capacity (l)	Weight (kg)	Box Size (cm)	Flow Rate (m³/h)	Accessories	Ladder	Accessories	Accessories	Barcode
KIT810ECO	800x470	120	33.630	298	1/90x80	6m³/h	✓	15	12	8 412081 266350	
KIT730ECO	730x375	120	25.323	287	1/90x80	4m³/h	✓	15	12	8 412081 211398	
KIT610ECO	610x375	120	20.893	235	1/80x60	4m³/h	✓	15	12	8 412081 211404	
KIT500ECO	500x300	120	14.550	224	1/80x60	4m³/h	✓	15	12	8 412081 231037	

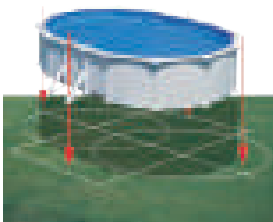

MEDIDA PISCINA
POOL SIZE
DIMENSIONS PISCINE
MISURA PISCINA

ESPACIO NECESARIO
NECESSARY SPACE
ESPACE NECESSAIRE
SPAZIO NECESSARIO

Model	Pool Size (cm)	Required Space (cm)
KIT810ECO	800x470	850x690
KIT730ECO	730x375	770x595
KIT610ECO	610x375	650x595
KIT500ECO	500x300	540x520



Liner PVC azul 30/100
KIT730/KIT610: 40/100
PVC blue liner 30/100
KIT730/KIT610: 40/100
Liner PVC bleu 30/100
KIT730/KIT610: 40/100
Liner PVC blu 30/100
KIT730/KIT610: 40/100



Protectores de inyección
Injection saver
Protections moulées par injection
Angolare di protezione

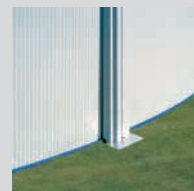

Perfilería de acero
Steel profiles
Poteaux et margelles acier
Profili in acciaio



KIT460ECO



EAN 13

Model	Pool Diameter	Pool Height	Volume	Weight	Box Size	Flow Rate	Water Inlet	Steps	Platform	Barcode
KIT550ECO	Ø550 cm	120 cm	24.944 l	209 kg	1/80x60	4m³/h	✓	15	12	8 4 120 81 2 114 11
KIT460ECO	Ø460 cm	120 cm	17.450 l	172 kg	1/80x60	4m³/h	✓	15	12	8 4 120 81 2 114 28
KIT350ECO	Ø350 cm	120 cm	10.102 l	146 kg	1/80x60	4m³/h	✓	15	12	8 4 120 81 2 114 35
KIT300ECO	Ø300 cm	120 cm	7.418 l	136 kg	1/80x60	4m³/h	✓	15	12	8 4 120 81 2 287 54
KIT240ECO	Ø240 cm	120 cm	4.750 l	126 kg	1/80x60	4m³/h	✓	15	12	8 4 120 81 2 408 31

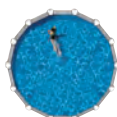

MEDIDA PISCINA
POOL SIZE
DIMENSIONS PISCINE
MISURA PISCINA

ESPACIO NECESARIO
NECESSARY SPACE
ESPACE NECESSAIRE
SPAZIO NECESSARIO

Model	Pool Diameter	Necessary Space
KIT550ECO	Ø 550 cm	600x600 cm
KIT460ECO	Ø 460 cm	500x500 cm
KIT350ECO	Ø 350 cm	400x400 cm
KIT300ECO	Ø 300 cm	350x350 cm
KIT240ECO	Ø 240 cm	300x300 cm



Depuradora arena
(Caudal grupo 6/4 m³/h)
Sand filter
(Flow group 6/4 m³/h)
Filtre à sable
(Débit groupe 6/4 m³/h)
Filtro a sabbia
(Portata gruppo 6/4 m³/h)



Escalera de seguridad
Plataforma
Safety Ladder
Platform
Échelle sécurité
Plateforme
Scala di sicurezza
Piattaforma

dream pool

serie **VARADERO**



KITPROV62270



EAN 13

	640x390 cm	120 cm	20.652 l	311 kg	1/90x80	4m ³ /h	√	√	15	12	8 412081 211633
KITPROV6270	640x390 cm	120 cm	20.652 l	311 kg	1/90x80	4m ³ /h	√	√	15	12	8 412081 211633
KITPROV4870	500x340 cm	120 cm	13.696 l	284 kg	1/90x80	4m ³ /h	√	√	15	12	8 412081 231921

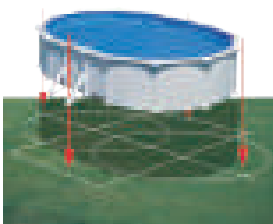

MEDIDA PISCINA
POOL SIZE
DIMENSIONS PISCINE
MISURA PISCINA

ESPACIO NECESARIO
NECESSARY SPACE
ESPACE NECESSAIRE
SPAZIO NECESSARIO

KITPROV6270	640x390 cm	700x430 cm
KITPROV4870	500x340 cm	540x380 cm



Liner PVC azul
40/100
PVC blue liner
40/100
Liner PVC bleu
40/100
Liner PVC blu
40/100



Protectores de
inyección
Injection saver
Protections
moulées par
injection
Angolare di
protezione



Perfilería de acero
Steel profiles
Poteaux et
margelles acier
Profili in acciaio



Viga de acero enterrada de 15x15 cm que hace innecesarios los postes exteriores, obteniendo mejor aprovechamiento del jardín.

15x15 cm buried steel beam makes unnecessary the outer buttress, optimizing the use of the garden area.

Poteaux en acier à enterrer de 15x15 cm évitant des renforts apparents extérieurs, pour mieux profiter de l'espace du jardin.

Barra di acciaio interrata da 15x15 cm che non rende necessario l'utilizzo delle barre laterali; permette di poter sfruttare al meglio gli spazi del proprio giardino.



Sistema de omegas Omega system Renforts enterrés Sistema omega



Depuradora arena
(Caudal grupo 4 m³/h)
Sand filter
(Flow group 4 m³/h)
Filtre à sable
(Débit groupe 4 m³/h)
Filtro a sabbia
(Portata gruppo 4 m³/h)



Escalera de seguridad
Plataforma
Safety Ladder
Platform
Échelle sécurité
Plateforme
Scala di sicurezza
Piattaforma



Tapiz protector
(Polietileno)
Floor tapestry
(Polythene)
Tapis de sol en feutre
(Polyéthylène)
Telo di protezione
(Polietilene)

dream pool

serie **BORA BORA**



KITPROV613



EAN 13

	Dimensions (cm)	Capacity (l)	Weight (kg)	Box Size (cm)	Flow Rate (m³/h)	Accessories	Accessories	Accessories	Accessories	Accessories	Barcode
KITPROV613	610x375 cm	20.893 l	210 kg	1/80x60	3,8m³/h	✓	15	12			8 412081 220437
KITPROV503	500x300 cm	14.550 l	205 kg	1/80x60	3,8m³/h	✓	15	12			8 412081 220260

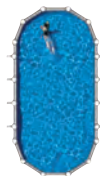
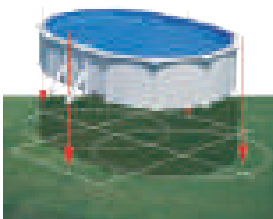

MEDIDA PISCINA
POOL SIZE
DIMENSIONS PISCINE
MISURA PISCINA

ESPACIO NECESARIO
NECESSARY SPACE
ESPACE NECESSAIRE
SPAZIO NECESSARIO

KITPROV613	610x375 cm	650x595 cm
KITPROV503	500x300 cm	540x520 cm



Liner PVC azul 30/100
KITPROV613: 40/100
PVC blue liner 30/100
KITPROV613: 40/100
Liner PVC bleu 30/100
KITPROV613: 40/100
Liner PVC blu 30/100
KITPROV613: 40/100



Protectores de inyección
Injection saver
Protections moulées par injection
Angolare di protezione



Perfilería de acero
Steel profiles
Poteaux et margelles acier
Profili in acciaio



KITPR453



EAN 13

	Ø	Height	Capacity	Weight	Box Size	Flow Rate	Waterproof	Accessories	Accessories	Barcode
KITPR453	Ø460 cm	120 cm	17.450 l	149 kg	1/80x40	3,8m ³ /h	✓	15	12	8 412081 209005
KITPR353	Ø350 cm	120 cm	10.102 l	109 kg	1/80x40	3,8m ³ /h	✓	15	12	8 412081 209012
KITPR303	Ø300 cm	120 cm	7.418 l	94 kg	1/80x40	3,8m ³ /h	✓	15	12	8 412081 233901

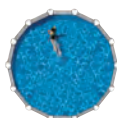

MEDIDA PISCINA
POOL SIZE
DIMENSIONS PISCINE
MISURA PISCINA

ESPACIO NECESARIO
NECESSARY SPACE
ESPACE NECESSAIRE
SPAZIO NECESSARIO

	Pool Diameter	Necessary Space
KITPR453	Ø 460 cm	500x500 cm
KITPR353	Ø 350 cm	400x400 cm
KITPR303	Ø 300 cm	350x350 cm



Filtro de cartucho
(3,8 m³/h)
Cartidge filter
(3,8 m³/h)
Filtre à cartouche
(3,8 m³/h)
Filtro a cartuccia
(3,8 m³/h)



Escalera de seguridad
Plataforma
Safety Ladder
Platform
Échelle sécurité
Plateforme
Scala di sicurezza
Piattaforma

dream pool

serie **LANZAROTE**

KITWPR452E



EAN 13

	Ø	H	V	P	W	F	L	C	ES	ES	Barcode
KITWPR452E	Ø450 cm	90 cm	12.717 l	56 kg	8/120x80	2m³/h	√	3,5	3,5	8 412081 241418	
KITWPR352E	Ø350 cm	90 cm	7.693 l	47 kg	8/120x80	2m³/h	√	3,5	3,5	8 412081 241401	
KITWPR302	Ø300 cm	90 cm	6.358 l	44 kg	8/120x80	2m³/h	√	3,5	3,5	8 412081 231044	

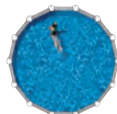

MEDIDA PISCINA
POOL SIZE
DIMENSIONS PISCINE
MISURA PISCINA

ESPACIO NECESARIO
NECESSARY SPACE
ESPACE NECESSAIRE
SPAZIO NECESSARIO

KITWPR452E	Ø 450 cm	500x500 cm
KITWPR352E	Ø 350 cm	400x400 cm
KITWPR302	Ø 300 cm	350x350 cm



Liner PVC azul
20/100
PVC blue liner
20/100
Liner PVC bleu
20/100
Liner PVC blu
20/100



Filtro de cartucho:
2 m³/h
Cartidge filter
2 m³/h
Filtre à cartouche
2 m³/h
Filtro a cartuccia
2 m³/h

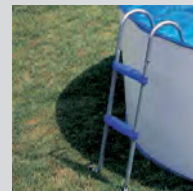

Escalera
2x2 Peldaños
Ladder
2x2 Steps
Échelle
2x2 Marches
Scala
2x2 Gradini

dream pool

serie **TENERIFE**



KITWPR450E



EAN 13

	Ø	H	VOLUME	WEIGHT	BOX DIMENSIONS	PUMP FLOW	✓	DEPTH	DEPTH	EAN 13
KITWPR450E	Ø450 cm	90 cm	12.717 l	56 kg	8/120x80	2m³/h	✓	3,5	3,5	8 4 120 8 1 2 4 1 2 1 0
KITWPR350E	Ø350 cm	90 cm	7.693 l	47 kg	8/120x80	2m³/h	✓	3,5	3,5	8 4 120 8 1 2 4 1 2 0 3

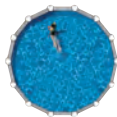
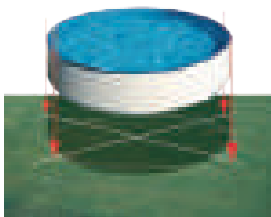

	MEDIDA PISCINA POOL SIZE DIMENSIONS PISCINE MISURA PISCINA	ESPACIO NECESARIO NECESSARY SPACE ESPACE NECESSAIRE SPAZIO NECESSARIO
KITWPR450E	Ø 450 cm	500x500 cm
KITWPR350E	Ø 350 cm	400x400 cm

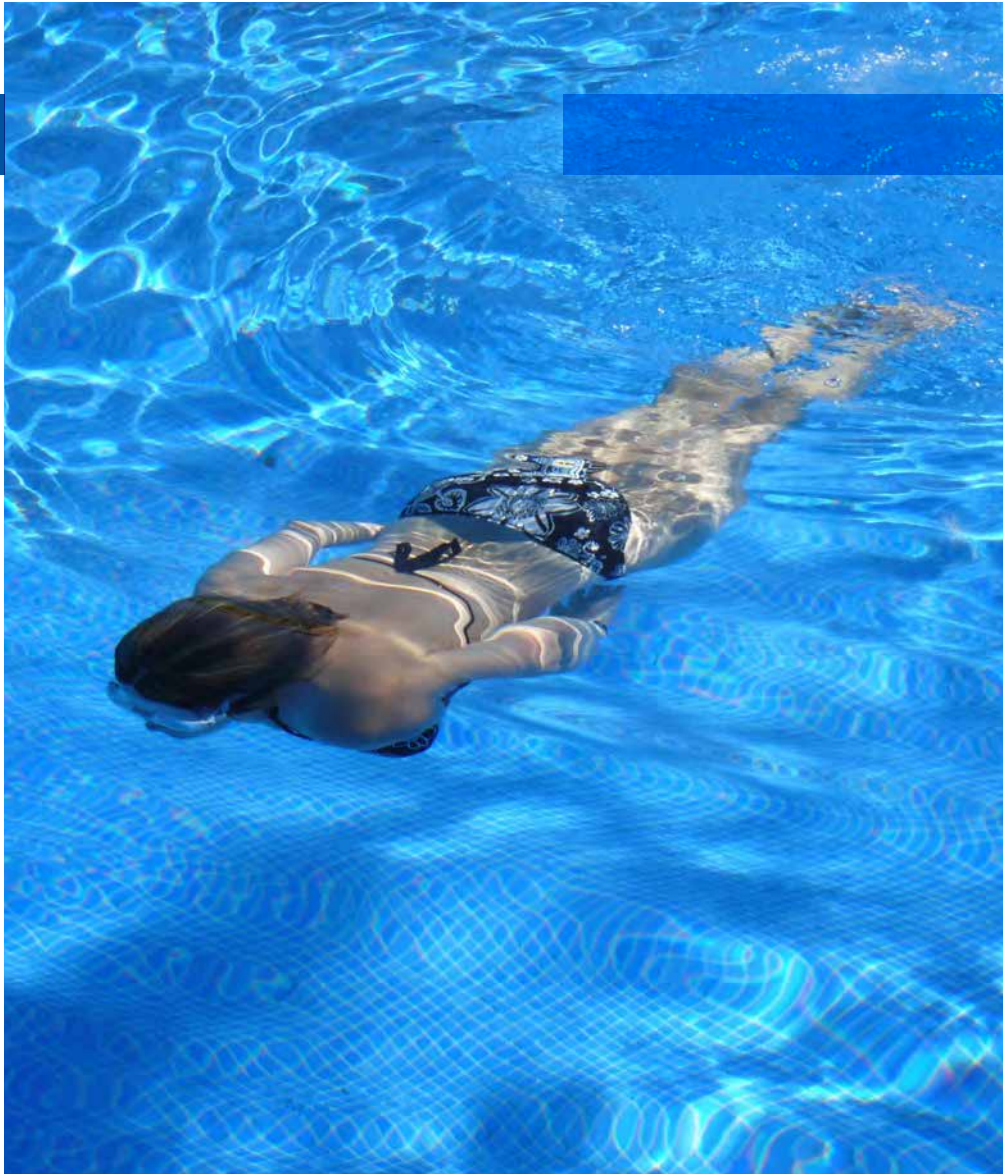

■ Leyenda ■ Legend ■ Légende ■ Legend

BX

caja
box
box
scatola

BXL

caja con etiqueta
box and label
carton avec étiquette
scatola con etichetta

CB

cartoncillo
cardboard wrap
bande carton
cartone

PBH

bolsa de plástico con cartoncillo
polybag with header
sac plastique avec bande carton
sacchetto di plastica con cartone

BL

blister
blister
blister
blister

CS

doble burbuja
clamshell
double coque
doppio rivestimento

CBX

caja litografiada
colour box
boîte de couleur
scatola serigrafata

PB

bolsa de plástico
polybag
sac plastique
busta di plastica

DIS

display
display
display
display

complementos complements

COMPLEMENTOS	82	COMPLEMENTS
Cubiertas isotérmicas para piscinas de madera	84	Wooden pool isothermic covers
Cubiertas de invierno para piscinas de madera	85	Wooden pool winter covers
Cubiertas isotérmicas para piscinas de composite	86	Composite pool isothermic covers
Cubiertas de invierno para piscinas de composite	86	Composite pool winter covers
Cubiertas isotérmicas para piscinas enterrada	87	In ground pool isothermic covers
Cubiertas isotérmicas	88	Isothermic covers
Cubiertas de invierno	89	Winter covers
Mantas	90	Bottom protective blankets
Enrolladores de cubiertas	91	Telescopic cover rollers
Liners	93	Liners
Protectores	96	Protectors
Reparadores de liner	99	Liner repairs
Escaleras para piscinas enterradas	100	Inground pool ladders
Escaleras para piscina de madera	101	Wooden pool ladder
Escaleras para piscinas sobre suelo	102	Above-ground pool ladders
Monoblocs de filtración	104	Filtration kit
Bombas	106	Pumps
Locales técnicos	108	Technical rooms
Cargas filtrantes	109	Filter media
Mangueras de filtración	110	Filtration hoses
Adaptadores	111	Adapters
Skimmers	112	Skimmers
Repuestos de filtración	112	Filtration spare parts
Filtros de Cartucho	115	Cartridge filter
Cartuchos	115	Cartridges
Blue Connect	116	Blue Connect
Electrolisis de sal	116	Electrolysis of salt
Sistemas de dosificación	119	Dosing systems
Deporte en la piscina	120	Pool Fitness
Seguridad piscina	121	Pool security
Iluminación	122	Lighting
Calefacción	126	Heating systems
Calefacción solar	128	Solar heating system
Duchas	129	Showers
Racordería	134	PVC Fittings

compléments complementi

COMPLÉMENTS	82	COMPLEMENTI
Couvertures isothermes pour piscines bois	84	Coperture isothermiche per piscine in legno
Couvertures pour l'hiver pour piscines bois	85	Copertura invernale per piscine in legno
Couvertures isothermes pour piscines composite	86	Coperture isothermiche per piscine composite
Couvertures pour l'hiver pour piscines composite	86	Copertura invernale per piscine composite
Couvertures isothermes pour piscines enterrées	87	Copertura isothermiche per piscine interrata
Couvertures isothermes	88	Coperture isothermiche
Couvertures pour l'hiver	89	Copertura invernale
Tapis de sol	90	Telo di protezione fondi
Enrouleurs de bâches	91	Avvolgitore
Liners	93	Liners
Protecteurs	96	Protezioni
Réparation liner	99	Riparazione liner
Échelles pour piscines enterrées	100	Scaletta per piscina interrata
Échelle pour piscines bois	101	Scaletta per piscina in legno
Échelles pour piscines hors sol	102	Scaletta per piscina fuori terra
Filtres a sable	104	Filtro monoblocco
Pompes	106	Pompe
Local technique	108	Locale tecnico
Médias filtrants	109	Carico filtrante
Tuyaux pour épurateurs	110	Tubi di filtraggio
Adaptateurs	111	Adattatori
Skimmers	112	Skimmers
Accessoires pour filtration	112	Filtraggio parti
Epurateurs à cartouche	115	Filtri a cartuccia
Cartouches	115	Cartucce
Blue Connect	116	Blue Connect
Electrolyse au sel	116	Elettrolisi salina
Système de dosage	119	Sistemi di dosaggio
Fitnes piscine	120	Fitness in piscina
Protection pour piscine	121	Protezione per piscine
Éclairage	122	Illuminazione
Chauffage	126	Riscaldamento
Chauffage solaire	128	Riscaldamento solare
Douches	129	Docce
Raccords PVC	134	Raccorderia in PVC

■ complementos ■ complements

CUBIERTAS ISOTÉRMICAS PARA PISCINAS DE MADERA WOODEN POOL ISOTHERMIC COVERS BÂCHES ÉTÉ POUR PISCINES BOIS COPERTURE ISOTERMICHE PER PISCINE IN LEGNO

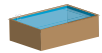

EAN 13

786642 CARDAMON 788033	1113x375	400 µ	-	-	1118x380	-	BXL pack 1	3605217866424
786641 MINT 788032	965x375	400 µ	-	-	970x380	-	BXL pack 1	3605217866417
786640 ANISE 788031	865x275	400 µ	-	-	870x280	-	BXL pack 1	3605217866400
CV790207 BRAGA 790207	762x368	400 µ	-	-	767x373	-	BXL pack 1	8412081308333
788922 BRAGA 790095	747X347	400 µ	-	-	752X352	-	BXL pack 1	3605217889225
CV790206 EVORA 790206	565x368	400 µ	-	-	570x373	-	BXL pack 1	8412081308340
788921 EVORA 790094	547X347	400 µ	-	-	552X352	-	BXL pack 1	3605217889218
788453 MARBELLA 790096	374x224	400 µ	-	-	379x229	-	BXL pack 1	3605217884534
CV790205 CARRA 790205	300x300	400 µ	-	-	-	305x305	BXL pack 1	8412081308302
788920 CARRA 790093	262X262	400 µ	-	-	-	267X267	BXL pack 1	3605217889201
CV790209 AVILA 790209	870x523	400 µ	875x528	-	-	-	BXL pack 1	8412081308319
786637 AVILA 790092	889X539	400 µ	894X544	-	-	-	BXL pack 1	3605217866370
CV790208 SEVILLA 790208	800x402	400 µ	805x407	-	-	-	BXL pack 1	8412081308326
786636 SEVILLA 790091	818X418	400 µ	823X423	-	-	-	BXL pack 1	3605217866363
786634 VERMELA 790098	618x418	400 µ	623x423	-	-	-	BXL pack 1	3605217866349
784800 SAFRAN 790089	585x360	400 µ	590x365	-	-	-	BXL pack 1	3605217848000
779532 CANELLE 790087	498x298	400 µ	503x303	-	-	-	BXL pack 1	3605217795328
779530 GRENADE 790086	398x298	400 µ	403x303	-	-	-	BXL pack 1	3605217795304
784799 VIOLETTE 790085	453 ø	400 µ	-	460 ø	-	-	BXL pack 1	3605217847997
779524 VANILLE 790083	350 ø	400 µ	-	355 ø	-	-	BXL pack 1	3605217795243
787057 LILI 790080	250 ø	400 µ	-	255 ø	-	-	BXL pack 1	3605217870575
CV790210 ANANAS 790210	371 ø	400 µ	-	376 ø	-	-	BXL pack 1	8412081308272
CV790203 AVOCADO 790203	603x403	400 µ	608x408	-	-	-	BXL pack 1	8412081308289
790073 CAMOMILLE 790202	568x343	400 µ	573x348	-	-	-	BXL pack 1	3605217900939
CVKPBOC632 MACADAMIA KPBOC632	580x282	400 µ	585x287	-	-	-	BXL pack 1	8412081273488
CVKPBOC535 BAMBU KPBOC535	482x282	400 µ	487x287	-	-	-	BXL pack 1	8412081273471
CVKPBRC620 MANGO KPBOC620	563x268	400 µ	-	-	568x273	-	BXL pack 1	8412081273501
CV790204 LEMON 790204	345x170	400 µ	-	-	350x175	-	BXL pack 1	8412081308296

■ compléments ■ complementi

CUBIERTAS DE INVIERNO PARA PISCINAS DE MADERA WOODEN POOL WINTER COVERS BÂCHES HIVER POUR PISCINES BOIS COPERTURE INVERNALE PER PISCINE IN LEGNO

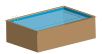
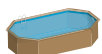

EAN 13

778042 CARDAMON 788033	1258x467	580 g/m ²	-	-	1218x427	-	BXL pack 1	3605217780423
778041 MINT 788032	1058x467	580 g/m ²	-	-	1018x427	-	BXL pack 1	3605217780416
778040 ANISE 788031	958x367	580 g/m ²	-	-	918x327	-	BXL pack 1	3605217780409
C1790207 BRAGA 790207	855x460	580 g/m ²	-	-	815x420	-	BXL pack 1	8412081308425
788927 BRAGA 790095	840x440	580 g/m ²	-	-	800x400	-	BXL pack 1	3605217889270
C1790206 EVORA 790206	660x460	580 g/m ²	-	-	620x420	-	BXL pack 1	8412081308432
788926 EVORA 790094	572x372	580 g/m ²	-	-	600x400	-	BXL pack 1	3605217889263
788452 MARBELLA 790096	467x317	580 g/m ²	-	-	427x277	-	BXL pack 1	3605217884527
C1790205 CARRA 790205	345x345	580 g/m ²	-	-	-	305x305	BXL pack 1	8412081308395
788925 CARRA 790093	340x340	580 g/m ²	-	-	-	300x300	BXL pack 1	3605217889256
790001 CITY	250x250	580 g/m ²	-	-	-	225x225	BXL pack 1	3605217900012
C1790209 AVILA 790209	963x616	580 g/m ²	923x576	-	-	-	BXL pack 1	8412081308401
786639 AVILA 790092	982x632	580 g/m ²	942x592	-	-	-	BXL pack 1	3605217866394
C1790208 SEVILLA 790208	865x495	580 g/m ²	852x455	-	-	-	BXL pack 1	8412081308418
621104 SEVILLA 790091	912x512	580 g/m ²	872x472	-	-	-	BXL pack 1	3605216211041
621103 VERMELA 790098	712x512	580 g/m ²	672x472	-	-	-	BXL pack 1	3605216211034
779537 SAFRAN 790089	677x452	580 g/m ²	637x412	-	-	-	BXL pack 1	3605217795373
786754 CANELLE 790087	591x391	580 g/m ²	551x351	-	-	-	BXL pack 1	3605217867544
779531 GRENADE 790086	476x376	580 g/m ²	436x336	-	-	-	BXL pack 1	3605217795311
784801 VIOLETTE 790085	551 ø	580 g/m ²	-	511 ø	-	-	BXL pack 1	3605217848017
779525 VANILLE 790083	452 ø	580 g/m ²	-	412 ø	-	-	BXL pack 1	3605217795250
787058 LILI 790080	335 ø	580 g/m ²	-	295 ø	-	-	BXL pack 1	3605217870582
C1790210 ANANAS 790210	468 ø	580 g/m ²	-	428 ø	-	-	BXL pack 1	8412081308364
C1790203 AVOCADO 790203	696x496	580 g/m ²	656x456	-	-	-	BXL pack 1	8412081308371
790063 CAMOMILLE 790202	660x435	580 g/m ²	620x395	-	-	-	BXL pack 1	3605217900630
CIKPBOC632 MACADAMIA KPBOC632	672x375	580 g/m ²	632x335	-	-	-	BXL pack 1	8412081273525
CIKPBOC535 BAMBU KPBOC535	575x375	580 g/m ²	535x335	-	-	-	BXL pack 1	8412081273518
CIKPBR620 MANGO KPBR620	658x360	580 g/m ²	-	-	618x320	-	BXL pack 1	8412081273549
C1790204 LEMON 790204	415x240	580 g/m ²	-	-	375x200	-	BXL pack 1	8412081308388

Material: PVC armado Material: Armed PVC
Matériau: PVC armé Materiale: PVC armato

■ complementos ■ complements

CUBIERTAS ISOTÉRMICAS PARA PISCINAS DE COMPOSITE COMPOSITE POOL ISOTHERMIC COVERS BÂCHES ÉTÉ POUR PISCINES COMPOSITE COPERTURE ISOTERMICHE PER PISCINE COMPOSITE



Material: Polietileno
Material: Polyethylene
Matériau: Polyéthylène
Materiale: Polietilene



EAN 13

CVKPCOR60	560x280	400 µ	-	-	-	606x326	BXL pack 1	8 412081 273709
CVKPCOR46	420x280	400 µ	-	-	-	466x326	BXL pack 1	8 412081 304885
CVKPCOR2814	275x135	400 µ	-	-	-	326x186	BXL pack 1	8 412081 304977
CVKPCOR28	275x275	400 µ	-	-	326x326	-	BXL pack 1	8 412081 302690
CVKPCO80	753x333	400 µ	-	758x338	-	-	BXL pack 1	8 412081 270661
CVKPCO66	613x333	400 µ	-	618x338	-	-	BXL pack 1	8 412081 270654
CVKPCO52	473x333	400 µ	-	478x338	--	-	BXL pack 1	8 412081 270647
CVKPCO41	Ø 361	400 µ	Ø 366	-	-	-	BXL pack 1	8 412081 270630

CUBIERTAS DE INVIERNO PARA PISCINAS DE COMPOSITE COMPOSITE POOL WINTER COVERS BÂCHES HIVER POUR PISCINES COMPOSITE COPERTURE INVERNALE PER PISCINE COMPOSITE



Material: PVC armado
Material: Armed PVC
Matériau: PVC armé
Materiale: PVC armato



EAN 13

CIKPCOR60	640x360	580 g/m ²	-	-	-	606x326	BXL pack 1	8 412081 273723
CIKPCOR46	444x304	580 g/m ²	-	-	-	466x326	BXL pack 1	8 412081 304892
CIKPCO2814	412x272	580 g/m ²	-	-	-	326x186	BXL pack 1	8 412081 304984
CIKPCOR28	360x360	580 g/m ²	-	-	326x326	-	BXL pack 1	8 412081 302706
CIKPCO80	828x408	580 g/m ²	-	804x386	-	-	BXL pack 1	8 412081 270708
CIKPCO66	688x408	580 g/m ²	-	664x386	-	-	BXL pack 1	8 412081 270692
CIKPCO52	548x408	580 g/m ²	-	524x386	-	-	BXL pack 1	8 412081 270685
CIKPCO41	Ø 440	580 g/m ²	Ø 410	-	-	-	BXL pack 1	8 412081 270678

CUBIERTAS ISOTÉRMICAS PARA PISCINAS ENTERRADAS IN-GROUND POOLS
ISOTHERMIC COVERS BÂCHES ÉTÉ POUR PISCINES ENTERRÉES COPERTURE
ISOTERMICHE PER PISCINE INTERRATA



Material: Polietileno
Material: Polyethylene
Matériau: Polyéthylène
Materiale: Polietilene

							EAN 13
CVPE800	795x395	300 µ	-	800x400	-	BXL pack 1	8 412081 273907
CVPE700	695x315	300 µ	-	700x320	-	BXL pack 1	8 412081 273914
CVPE600	595x315	300 µ	-	600x320	-	BXL pack 1	8 412081 273921
CVPE500	495x295	300 µ	-	500x300	-	BXL pack 1	8 412081 273938
CVPE420	Ø 415	300 µ	Ø 420	-	-	BXL pack 1	8 412081 273945
CVPE350	Ø 345	300 µ	Ø 350	-	-	BXL pack 1	8 412081 273952
CPERT105	995x495	180 µ	-	-	1000x500	BXL pack 1	8 412081 268354
CPERT95	895x495	180 µ	-	-	900x500	BXL pack 1	8 412081 268347
CPERT84	795x395	180 µ	-	-	800x400	BXL pack 1	8 412081 268330
CPERT63	595x295	180 µ	-	-	600x300	BXL pack 1	8 412081 268323
CPERT53	495x295	180 µ	-	-	500x300	BXL pack 1	8 412081 268316

■ complementos ■ complements

CUBIERTAS ISOTÉRMICAS ISOTHERMIC COVERS COUVERTURES ISOTHERMES COPERTURE ISOTHERMICHE

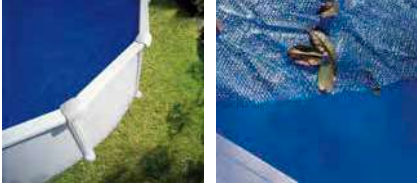

Material: Polietileno
Material: Polyethylene
Matériau: Polyéthylène
Materiale: Polietilene



EAN 13

CPROV1020	995x545	180 μ	-	1000x550	-	-	-	PBH pack 1	8 412081 220536
CPROV915	910x460	180 μ	-	915x470	-	-	-	PBH pack 1	8 412081 980324
CPROV810	805x460	180 μ	-	810x470	-	-	-	PBH pack 1	8 412081 205984
CPROV730	725x370	180 μ	-	730x375	-	-	-	PBH pack 1	8 412081 980331
CPROV610	605x370	180 μ	-	610x375	-	-	-	PBH pack 1	8 412081 205991
CPROV510	485x335	180 μ	-	500x350	-	-	-	PBH pack 1	8 412081 268811
CPROV505	495x295	180 μ	-	500x300	-	-	-	PBH pack 1	8 412081 221823
CPROV700	672x445	180 μ	-	-	710x475	-	-	PBH pack 1	8 412081 205830
CPROV600	620x370	180 μ	-	-	640x390	-	-	PBH pack 1	8 412081 205847
CPROV500	472x305	180 μ	-	-	500x340	-	-	PBH pack 1	8 412081 205854
CPR650	635 ø	180 μ	-	-	-	ø 640	-	PBH pack 1	8 412081 950303
CPR550	545 ø	180 μ	-	-	-	ø 550	-	PBH pack 1	8 412081 940601
CV450	455 ø	180 μ	ø 550	-	-	ø 460	ø 450/460	PBH pack 1	8 412081 202525
CPR400	395 ø	180 μ	-	-	-	-	ø 400	PBH pack 1	8 412081 940625
CV350	345 ø	180 μ	ø 450	-	-	ø 350	ø 350	PBH pack 1	8 412081 202532
CV300	295 ø	180 μ	ø 350	-	-	ø 300	ø 300	PBH pack 1	8 412081 202549
CV250	245 ø	180 μ	ø 300	-	-	ø 240	-	PBH pack 1	8 412081 208565
773326	725x370	267 μ	-	730x375	-	-	-	PBH pack 1	3 605217 733269
773324	605x370	267 μ	-	610x375	-	-	-	PBH pack 1	3 605217 733245
773322	485x335	267 μ	-	500x350	-	-	-	PBH pack 1	3 605217 733221
773320	ø 550	267 μ	ø 555	-	-	ø 550	-	PBH pack 1	3 605217 733207
772999	ø 460	267 μ	ø 465	-	-	ø 460	-	PBH pack 1	3 605217 729996
772997	ø 360	267 μ	ø 365	-	-	ø 360	-	PBH pack 1	3 605217 729972

CUBIERTAS DE INVIERNO WINTER COVERS
COUVERTURES POUR L'HIVER COPERTURA INVERNALE



Material: Polietileno
Material: Polyethylene
Matériau: Polyéthylène
Materiale: Polietilene



EAN 13

NEW 2020	CIPROV731P	820x460	180 g/m ²	-	-	730x375	640x390	-	-	CBX pack 3	
NEW 2020	CIPROV611P	680x460	180 g/m ²	-	-	610x375	500x340	-	-	CBX pack 3	
NEW 2020	CIPROV501P	610x410	180 g/m ²	-	-	500x300	-	-	-	CBX pack 3	
NEW 2020	CIPR451P	540 ø	180 g/m ²	-	ø 550	-	-	ø 460	ø 400	CBX pack 5	
NEW 2020	CIPR351P	440 ø	180 g/m ²	-	ø 350 ø 360	-	-	ø 350	ø 350	CBX pack 5	
	CIPROV1001	1115x660	120 g/m ²	-	-	1000x550	-	-	-	CBX pack 3	
	CIPROV911	1030x560	120 g/m ²	-	-	915x470	-	-	-	CBX pack 3	
	CIPROV821	930x560	120 g/m ²	-	-	800x470	710x475	-	-	CBX pack 3	
	CIPROV731	820x460	120 g/m ²	-	-	730x375	640x390	-	-	CBX pack 3	
	CIPROV611	680x460	120 g/m ²	-	-	610x375	500x340	-	-	CBX pack 3	
	CIPROV501	610x410	120 g/m ²	-	-	500x300	-	-	-	CBX pack 3	
	CIPR651	730 ø	120 g/m ²	-	-	-	-	ø 640	-	CBX pack 3	
	CIPR551	640 ø	120 g/m ²	-	-	-	-	ø 550	-	CBX pack 5	
	CIPR451	540 ø	120 g/m ²	-	ø 550	-	-	ø 460	ø 450 ø 460	CBX pack 5	
	CIPR401	480 ø	120 g/m ²	ø 440	ø 450	-	-	-	ø 400	CBX pack 5	
	CIPR351	440 ø	120 g/m ²	ø 360	ø 350 ø 360	-	-	ø 350	ø 350	CBX pack 5	
	CIPR301	380 ø	120 g/m ²	-	-	-	-	ø 300	-	CBX pack 5	
	CIPR241	330 ø	120 g/m ²	-	-	-	-	ø 240	-	CBX pack 5	

■ complementos ■ complements

MANTAS PROTECTORAS BOTTOM PROTECTIVE BLANKET POUR LE SOL DES PISCINES COUVERTURES DE PROTECTION DU FOND TAPPETO DI PROTEZIONE



Material: Poliéster
 Material: Polyester
 Matériau: Polyester
 Materiale: Poliestere



EAN 13

MPROVT100	1100x600	110 g/m ²	-	-	-	1000x550	-	-	-	PBH pack 1	
MPROV915	950x500	110 g/m ²	-	-	-	915x470	-	-	-	PBH pack 1	
MPROV810	825x500	110 g/m ²	780x400	-	780x400	810x470	710x475	-	-	PBH pack 1	
MPROV730	750x400	110 g/m ²	660x280	-	660x280	730x375	640x390	-	-	PBH pack 1	
MPROV610	625x400	110 g/m ²	530x280	-	530x280	610x375	500x340	-	-	PBH pack 1	
MPROV500	525x325	110 g/m ²	-	-	-	500x300	-	-	-	PBH pack 1	
MPR650	650x650	110 g/m ²	-	-	-	-	-	ø 640	-	PBH pack 1	
MPR550	550x550	110 g/m ²	-	-	ø 550	-	-	ø 550	-	PBH pack 1	
MPR450	450x450	110 g/m ²	-	ø 440	ø 450	-	-	ø 460 ø 450	ø 460	PBH pack 1	
MPR400	400x400	110 g/m ²	-	ø 360	-	-	-	ø 350	ø 400	PBH pack 1	
MPR350	350x350	110 g/m ²	-	-	ø 350	-	-	ø 350 ø 300	ø 350	PBH pack 1	
MPR250	250x250	110 g/m ²	-	-	ø 240	-	-	ø 240	-	PBH pack 1	

■ ENROLLADORES DE CUBIERTAS ■ TELESCOPIC COVER ROLLERS
 ■ ENROULEURS DE BÂCHES ■ AVVOGLITORE PER PISCINE

REF. 90171

BXL PACK 1



Enrollador piscinas enterradas

Enrollador de cubierta para piscinas enterradas. Ofrece un desarrollo máximo de 5,50m. Ideal para piscinas redondas, cuadradas u ovaladas. Contiene tubos redondos en aluminio anodizado, un volante ergonómico con empuñadura giratoria así como un kit para atar la cubierta.

Enrouleur pour piscines enterrées

Enrouleur de bâche pour piscines enterrées. Il offre un développement maximum de 5,50m. Il convient aux piscines rondes, carrées ou ovales. Il est équipé de tubes ronds en aluminium anodisés, d'un volant ergonomique avec poignée tournante et d'un kit d'attache pour bâche. Cet enrouleur est livré en un seul colis, packaging couleur.

Cover roller for inground pools

Winder cover for in ground pools. Unfolds to a maximum length of 5.50 m. Suitable for round, square or oval swimming pools. Includes round anodised aluminium tubes, an ergonomic hand wheel with revolving handle as well as a kit to attach it to the cover.

Avvolgitore per piscine interrate

Avvolgitore "grandi ruote" per piscine interrate. Si srotola fino a un massimo di 5.50m. Adatto per le piscine tonde, quadrate e ovali. Contiene un tubo in alluminio anodizzato, una ghiera ergonomica con una impugnatura rotatoria e un kit per fissare la copertura. Consegnato in un unico imballo.

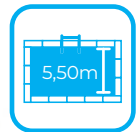

REF. 90172

BXL PACK 1



Enrollador de cubierta para piscinas enterradas

Ofrece un desarrollo máximo de 5,50m. Ideal para piscinas redondas, cuadradas u ovaladas. Contiene tubos redondos en aluminio, un volante ergonómico con empuñadura giratoria así como un kit para atar la cubierta.

Enrouleur de bâche pour piscines enterrées

Il offre un développement maximum de 5,50m. Il convient aux piscines rondes, carrées ou ovales. Il est équipé de tubes ronds en aluminium, d'un volant ergonomique avec poignée tournante et d'un kit d'attache pour bâche. Cet enrouleur est livré en un seul colis, packaging couleur.

Cover roller for inground pools

Unfolds to a maximum length of 5.50 m. Suitable for round, square or oval swimming pools. Includes round aluminium tubes, an ergonomic hand wheel with revolving handle as well as a kit to attach it to the cover.

Avvolgitore di copertura per piscine interrate

Si srotola fino a un massimo di 5.50m. Adatto per le piscine tonde, quadrate e ovali. Contiene un tubo in alluminio, una ghiera ergonomica con una impugnatura rotatoria e un kit per fissare la copertura. Consegnato in un unico imballo.

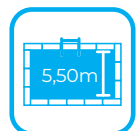

NEW
2020



REF. CRP58

CBX PACK 1



Enrollador básico piscinas elevadas

Enrollador de cubiertas de verano hasta 5,8m de ancho. Tubo telescópico en aluminio. Para piscinas tubulares, de acero y madera. Fácil instalación.

Basic cover roller for above-ground pools

Cover roller for summer covers above ground pools up to 5,8 m wide. Telescopic tube in aluminium. For tubular, steel and wooden pools. Easy to install.

Enrouleur pour piscines hors-sol

Enrouleur bâche été pour piscines jusqu'à 5,80m de largeur. Tubes télescopiques en aluminium. Il s'adapte aussi bien sur les piscines tubulaires que sur les piscines de acier et bois. Facile à installer

Avvolgitore per piscine fuoritera

Avvolgitore per copertura estive fino a 5,8 m di larghezza. Tubo telescopico in alluminio. Per piscine tubolari, d'acciaio e legno. Facile installazione.



REF. 40135

CBX PACK 2



Enrollador piscinas elevadas

El Enrollador ofrece un desarrollo máximo de 6,5m. Se ata fácilmente a las "playas" de la piscina con 2 placas atornilladas. El uso del enrollador permite una mejor conservación de la cubierta. Incluido: Conectores para piscinas tubulares.

Cover roller for above-ground pools

The Winder unfolds to a maximum length of 6.5 m. It can be easily attached to the "edge" finishing pieces of the pool using 2 bolted plates. The use of the winder enables a better conservation of the cover. Included: Connectors for tubular pools.

Enrouleur pour piscines hors-sol

Enrouleur offrant un développement maximum de 6,5m. Il se fixe facilement sur les 2 "margelles" de la piscine grâce à ses 2 plaques vissées. Inclus: Connecteurs pour piscines tubulaires.

Avvolgitore per piscine fuoritera

Avvolgitore che si srotola fino a un massimo di 6.5 m. Si fissa facilmente alla "bordo" della piscina con 2 placche con viti. L'utilizzo dell'avvolgitore permette una migliore conservazione della copertura.



REF. 621535

BXL PACK 1



Enrollador piscinas elevadas Luxe

Enrollador para piscina en superficie de longitud entre 2,44 y 6,32 m. Giro sobre el eje para descubrir la superficie de nado. Travesaño de resina Sistema de enganche compatible con todas las cubiertas de verano. Tubos telescópicos de aluminio. Cintas de enganche.

Luxe cover roller for above-ground pools

Roller for pool surface between 2.44 and 6.32 m long. It turns on its axis to reveal the swimming surface. Resin cross member. Hook system compatible with all the summer canvases. Telescopic aluminium tubes. Webbing loop.



Enrouleur pour piscines hors-sol Luxe

Enrouleur pour piscine hors sol d'une largeur de 2,44 à 6,32 m. Pivote sur un axe pour libérer la surface de nage. Piètement en résine. Système d'accroche compatible avec toutes les bâches été. Tubes télescopiques en aluminium. Sangles d'accrochage.

Avvolgitore per piscine fuori terra Luxe

Avvolgitore per piscine fuori terra di lunghezza compresa tra 2,44 e 6,32 m. Ruotare sull'asse per scoprire la superficie di balneazione. Traversa in resina. Sistema di aggancio compatibile con tutti i tessuti estivi. Tubi telescopici in alluminio. Cinghie di aggancio.



IMPORTANT: These cover rollers can not be placed in any composite pool. There is a risk of breakage. **Importante:** Estos enrolladores no se pueden colocar en piscinas de composite, existe riesgo de rotura de las playas. **ATTENTION :** Cet enrouleur de bâche ne convient pas pour les piscines en composite. Il existe un risque de rupture des margelles. **IMPORTANTE:** Questo avvolgitore non si può installare in piscine in composito, esiste il rischio di rottura dei bordi piscina.

LINERS PARA PISCINA DE MADERA WOODEN POOL LINERS
LINERS POUR PISCINES BOIS LINERS PER PISCINE IN LEGNO



Liner azul (AZ)
 Blue liner (AZ)
 Liner bleu (AZ)
 Liner blu (AZ)



Liner beige (BE)
 Beige liner (BE)
 Liner beige (BE)
 Liner beige (BE)



Sistema colgante
 Hanging system
 Système d'accroche
 Con barra di agganciamento



EAN 13

783885	AZ	Ø 511	124cm	75/100	3 605217 838858
786214	BE				3 605217 862143
778689	AZ	Ø 412	119cm	50/100	3 605217 786890
786213	BE				3 605217 862136
786340	AZ	Ø 295	105cm	50/100	3 605217 863409
786329	AZ	Ø 295	119cm	50/100	3 605217 863294
786337	AZ	942x592	146cm	75/100	3 605217 863379
786219	BE				3 605217 862198
786336	AZ	872x472	146cm	75/100	3 605217 863362
786218	BE				3 605217 862181
786334	AZ	672x472	146cm	75/100	3 605217 863348
786217	BE				3 605217 862174
783809	AZ	637x412	133cm	75/100	3 605217 838094
786216	BE				3 605217 862167
778768	AZ	551x351	119cm	60/100	3 605217 787682
786215	BE				3 605217 862150
778767	AZ	436x336	119cm	60/100	3 605217 787675
785943	AZ	800x400	146cm	75/100	3 605217 859433
785939	AZ	600x400	133cm	75/100	3 605217 859396
785945	AZ	400x250	119cm	75/100	3 605217 859457
788044	AZ	300x300	119cm	60/100	3 605217 880444

■ complementos ■ complements

LINERS LINERS LINERS LINERS



Liner azul (AZ)
Blue liner (AZ)
Liner bleu (AZ)
Liner blu (AZ)



Liner gresite (GR)
Ceramics liner (GR)
Liner carrelage (GR)
Liner mosaicato (GR)



Sistema colgante (SC)
Hanging system (SC)
Système d'accroche (SC)
Con barra di agganciamento (SC)



Sistema overlap (OV)
Overlap system (OV)
Système à recouvrement (OV)
Sistema overlap (OV)



EAN 13

Product Code	Material	System	Diameter	Height	Quantity	Barcode
FPR557	GR	SC	Ø 550	132cm	50/100	8 412081 258249
FPR558	AZ			40/100	8 412081 214504	
FPR551	AZ	OV	120cm	40/100	8 412081 950648	
770398	GR	OV	120cm	75/100	3 605217 703989	
FPR457	GR	SC	Ø 460	132cm	50/100	8 412081 258256
FPR458	AZ			40/100	8 412081 224121	
FPR451	AZ			120cm	40/100	8 412081 980485
FSP450	AZ	OV	Ø 450	90cm	20/100	8 412081 990217
FSP400			Ø 400	90cm	20/100	8 412081 990224
FPR357	GR	SC	Ø 350	132cm	50/100	8 412081 258263
FPR358	AZ	SC		132cm	40/100	8 412081 233918
FPR352				120cm	40/100	8 412081 200576
FPR354				90cm	30/100	8 412081 201177
FSP350				OV	90cm	20/100
FPR301	AZ	SC	Ø 300	120cm	40/100	8 412081 216027
FSP300		OV		90cm	20/100	8 412081 203249
FWPR30		OV		65cm	20/100	8 412081 201191
FPR241		SC	Ø 240	120cm	40/100	8 412081 203010

■ compléments ■ complementi

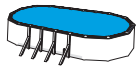

EAN 13

FPROV1028	AZ	SC	1000x550	132cm	40/100	 8 4 1 2 0 8 1 2 2 4 1 6 9
FPROV917	GR	SC	915x470	132cm	50/100	 8 4 1 2 0 8 1 2 5 8 1 9 5
FPROV918	AZ	SC		132cm	40/100	 8 4 1 2 0 8 1 2 1 4 5 1 1
FPROV915				120cm	40/100	 8 4 1 2 0 8 1 9 8 0 2 7 0
FPROV827	GR	SC		800x470	132cm	50/100
FPROV818	AZ	SC	132cm		40/100	 8 4 1 2 0 8 1 2 2 4 0 9 1
FPROV810			120cm		40/100	 8 4 1 2 0 8 1 2 0 6 0 5 9
FPROV737	GR	SC	730x375	132cm	50/100	 8 4 1 2 0 8 1 2 5 8 2 1 8
FPROV738	AZ	SC		132cm	40/100	 8 4 1 2 0 8 1 2 2 4 1 0 7
FPROV730				120cm	40/100	 8 4 1 2 0 8 1 9 8 0 2 8 7
770399	AZ	OV	730x375	120cm	75/100	 3 6 0 5 2 1 7 7 0 3 9 9 6
FPROV617	GR	SC	610x375	132cm	50/100	 8 4 1 2 0 8 1 2 5 8 2 2 5
FPROV618	AZ	SC		132cm	40/100	 8 4 1 2 0 8 1 2 2 4 1 1 4
FPROV610				120cm	40/100	 8 4 1 2 0 8 1 2 0 6 0 6 6
773486	AZ	OV	610x370	120cm	75/100	 3 6 0 5 2 1 7 7 3 4 8 6 0
FPROV5171	GR	SC	500x350	132cm	50/100	 8 4 1 2 0 8 1 2 6 8 7 6 7
FPROV5071	AZ			120cm	40/100	 8 4 1 2 0 8 1 2 6 8 7 5 0
FPROV517	GR	SC	500x300	132cm	50/100	 8 4 1 2 0 8 1 2 5 8 2 3 2
FPROV500	AZ			120cm	40/100	 8 4 1 2 0 8 1 2 2 1 8 7 8

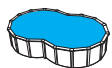

EAN 13

FPROV707	AZ	SC	700x450	120cm	40/100	 8 4 1 2 0 8 1 2 0 4 3 3 8
FPROV627	AZ	SC	625x375	120cm	40/100	 8 4 1 2 0 8 1 2 0 4 3 4 5
FPROV507	AZ	SC	500x310	120cm	40/100	 8 4 1 2 0 8 1 2 0 4 3 5 2

PROTECTORES PROTECTORS PROTECTEURS PROTEZIONE

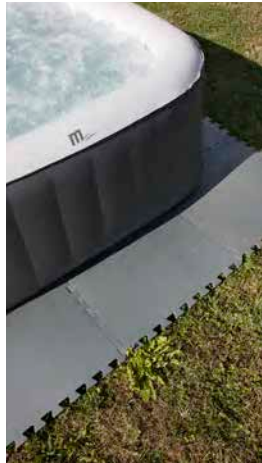

FLOOR PROTECTOR - SPECIAL SPA

REF. MPF509GY PB PACK 8 50x50cmx8mm



PROTECTOR DE SUELO DE PISCINA ANTIDESLIZANTE

Material duradero (Etilvinilacetato (EVA))
Ofrece una protección adicional para el fondo de la piscina. Contiene 9 piezas de 50x50cm = 2,25m²

NON SLEPPERY POOL FLOOR PROTECTOR

Durable material (Ethylene-vinyl acetate (EVA)).
Provides added protection for pool floors. Package contains 9 pieces of 50x50cm = 2,25m²

PROTECTEUR DE SOL DE PISCINE ANTIDÉRAPANT

Matériau durable (Éthylène-acétate de vinyle (EVA)).
Fournit une protection supplémentaire pour les sols de piscines. L'emballage contient 9 pièces 50x50cm = 2,25m²

PROTEZIONE PER IL FONDO DELLA PISCINA ANTISKID

In materiale resistente (Etilene vinil acetato (EVA)).
Evita che il fondo della piscina si danneggi.
Il package include 9 pezzi, 50x50cm = 2,25m²

FLOOR PROTECTOR

REF. MPF819 PB PACK 7

81x81cmx4,5mm



PROTECTOR DE SUELO DE PISCINA

Material duradero (Etilvinilacetato (EVA))
Ofrece una protección adicional para el fondo de la piscina. Contiene 9 piezas de 81x81cm = 5,90m²

POOL FLOOR PROTECTOR

Durable material (Ethylene-vinyl acetate (EVA)). Provides added protection for pool floors. Package contains 9 pieces of 81x81cm = 5,90m²

PROTECTEUR DE SOL DE PISCINE

Matériau durable (Éthylène-acétate de vinyle (EVA))
Fournit une protection supplémentaire pour les sols de piscines. L'emballage contient 9 pièces 81x81cm = 5,90m²

PROTEZIONE PER IL FONDO DELLA PISCINA

In materiale resistente (Etilene vinil acetato (EVA)).
Evita che il fondo della piscina si danneggi.
Il package include 9 pezzi, 81x81cm = 5,90m²

FLOOR PROTECTOR

REF. MPF509GR PB PACK 8

50x50cmx8mm



PROTECTOR DE SUELO DE PISCINA ANTIDESLIZANTE

Material duradero (Etilvinilacetato (EVA))
Ofrece una protección adicional para el fondo de la piscina. Contiene 9 piezas de 50x50cm = 2,25m²

NON SLEPPERY POOL FLOOR PROTECTOR

Durable material (Ethylene-vinyl acetate (EVA)).
Provides added protection for pool floors. Package contains 9 pieces of 50x50cm = 2,25m²

PROTECTEUR DE SOL DE PISCINE ANTIDÉRAPANT

Matériau durable (Éthylène-acétate de vinyle (EVA))
Fournit une protection supplémentaire pour les sols de piscines. L'emballage contient 9 pièces 50x50cm = 2,25m²

PROTEZIONE PER IL FONDO DELLA PISCINA ANTISKID

In materiale resistente (Etilene vinil acetato (EVA)).
Evita che il fondo della piscina si danneggi. Il package include 9 pezzi, 50x50cm = 2,25m²

FLOOR PROTECTOR

REF. MPF509P

PB PACK 14 50x50cmx8mm



PROTECTOR DE SUELO DE PISCINA ANTIDESLIZANTE

Material duradero (Etilvinilacetato (EVA)) Ofrece una protección adicional para el fondo de la piscina. Contiene 9 piezas de 50x50cm = 2,25m²

NON SLEPPERY POOL FLOOR PROTECTOR

Durable material (Ethylene-vinyl acetate (EVA)) Provides added protection for pool floors. Package contains 9 pieces of 50x50 = 2,25m²

PROTECTEUR DE SOL DE PISCINE ANTIDÉRAPANT

Matériau durable (Éthylène-acétate de vinyle (EVA)) Fournit une protection supplémentaire pour les sols de piscines. L'emballage contient 9 pièces 50x50cm = 2,25m²

PROTEZIONE PER IL FONDO DELLA PISCINA ANTISKID

In materiale resistente (Etilene vinil acetato (EVA)) Evita che il fondo della piscina si danneggi. Il package include 9 pezzi, 50x50cm = 2,25m²

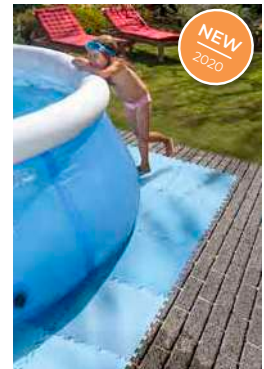

FLOOR PROTECTOR

REF. MPF509

PB PACK 14 50x50cmx4,5mm



PROTECTOR DE SUELO DE PISCINA

Material duradero (Etilvinilacetato (EVA)) Ofrece una protección adicional para el fondo de la piscina. Contiene 9 piezas de 50x50cm = 2,25m²

POOL FLOOR PROTECTOR

Durable material (Ethylene-vinyl acetate (EVA)) Provides added protection for pool floors. Package contains 9 pieces of 50x50 = 2,25m²

PROTECTEUR DE SOL DE PISCINE

Matériau durable (Éthylène-acétate de vinyle (EVA)) Fournit une protection supplémentaire pour les sols de piscines. L'emballage contient 9 pièces 50x50cm = 2,25m²

PROTEZIONE PER IL FONDO DELLA PISCINA

In materiale resistente (Etilene vinil acetato (EVA)) Evita che il fondo della piscina si danneggi. Il package include 9 pezzi, 50x50cm = 2,25m²

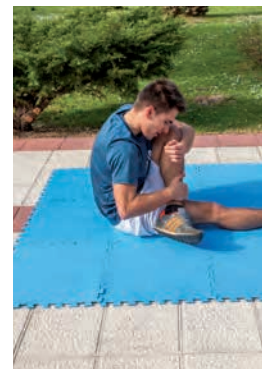

BOX MPF509

REF. MPF509BOX60

PB PACK 60 50x50cmx4,5mm



BOX PROTECTOR DE SUELO DE PISCINA

Material duradero (Etilvinilacetato (EVA)) El box contiene 60 unidades

BOX POOL FLOOR PROTECTOR

Durable material (Ethylene-vinyl acetate (EVA)). Box contains 60 units

BOX PROTECTEUR DE SOL DE PISCINE

Matériau durable (Éthylène-acétate de vinyle (EVA)). L'box contient 60 unités

BOX PROTEZIONE PER IL FONDO DELLA PISCINA

In materiale resistente (Etilene vinil acetato (EVA)). Il box include 60 unità



Delta MS®

REF. 772060

BXL PACK 1

20 x 1,5m



3 605217 720603

PROTECTOR DE PARED

Rollo de protección y de drenaje alveolar de PEAD (polietileno de alta densidad) para piscina de madera
1- Pared de piscina de madera
2- Rollo de protección y de drenaje alveolar de PEAD

WALL PROTECTOR

Protection and alveolar draining roll of HDPE (High Density Polyethylene) for wooden pool
1- Wood frame
2- Roll of alveolar protection an drainage of HDPE

ROULEAU DE PROTECTION

Pour piscine bois
Rouleau de protection et de drainage alvéolaire en PEHD (polyéthylène haute densité).
1 - Ossature bois
2 - Nappe à excroissances type Delta MS®

PROTEZIONE PER PARETE

Rotolo di protezione del drenaggio alveolare di HDPE (polietilene ad alta densità) per piscina in legno
1- Struttura in legno
2- Rotolo di protezione del drenaggio alveolare di HDPE

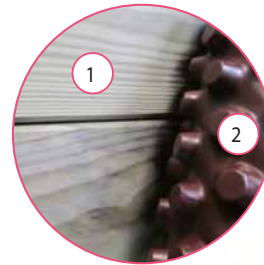

POOL HOUSE

REF. PH54

CBX PACK 1



8 412081 257532

TOLDO PISCINA

Dimensiones:
5,00 x 4,33 x 2,50 m
Material: Poliéster
Paneles laterales de PVC transparente
3 puertas con cierre de cremallera

POOL HOUSE

Assembled size:
5,00 x 4,33 x 2,50 m Material:
Polyester. Transparent PVC side walls. 3 doors with zipper close. Adaptable to 4m pools.

AUVENT DE PROTECTION

Dimensions :
5,00 x 4,33 x 2,50 m
Matériau : Polyester
Parois latérales en PVC transparent
3 portes avec fermeture éclair

GAZEBO DI PROTEZIONE

Dimensioni
: 5,00 x 4,33 x 2,50 m
Materiale: Poliestere
Pannelli laterali in PVC trasparente
3 porte con chiusura a zip



REPARADORES DE LINER LINER REPAIR
RÉPARATION LINER RIPARAZIONE LINER

REF. 40080

BL PACK 24 DIS



Kit reparación liner
 Kit réparation liner

Liner repair kit
 Kit riparazione liner



REF. V12

BL PACK 50



Kit reparador de PVC
 Kit réparation PVC

PVC repair kit
 Kit per riparazioni PVC



REF. AR202

BL PACK 96



Film reparador de PVC
 Film réparation PVC

PVC repair film
 Pellicola per riparare i liner



■ complementos ■ complements

ESCALERAS PARA PISCINA ENTERRADA INGROUND POOL LADDERS
ÉCHELLES POUR PISCINES ENTERRÉES SCALETTA PER PISCINA INTERRATA



REF. EIE30 BXL PACK 1



Escalera acero inoxidable AISI304 para piscina enterrada
3 peldaños dobles

AISI304 Stainless steel inground pool ladder
3 double steps

Échelle acier inoxydable AISI304 pour piscine enterrée
3 marches double

Scaletta Inox AISI304 per piscina interrata
3 gradini doppi



Ref. EPE30 BXL PACK 1



Escalera sintética para piscinas enterradas
4 peldaños

Easy access synthetic ladder for in ground pools
4 steps

Échelle synthétique d'entrée facile pour piscine enterrée
4 marches

Scaletta sintetica per piscina interrata
4 gradini

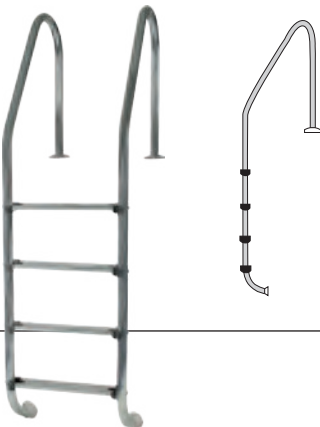

STANDARD
REF. 40272 BXL PACK 1



Escalera STANDARD para piscina enterrada de 4 peldaños Inox.

Stainless steel STANDARD inground pool ladder - 4 steps.

Échelle modèle STANDARD acier inoxydable pour piscine enterrée - 4 marches

Scaletta STANDARD per piscina interrata da 4 gradini - Inox

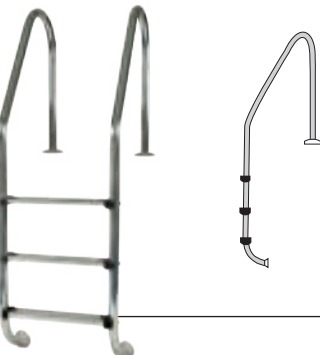

STANDARD
REF. 40110 BXL PACK 1



Escalera STANDARD para piscina enterrada de 3 peldaños Inox.

Stainless steel STANDARD inground pool ladder - 3 steps.

Échelle modèle STANDARD acier inoxydable pour piscine enterrée - 3 marches

Scaletta STANDARD per piscina interrata da 3 gradini - Inox

WALL

REF. 40274

BXL PACK 1



Escalera MURO para piscina enterrada de 4 peldaños – Inox

Stainless steel inground pool WALL ladder - 4 steps

Échelle MURALE acier inoxydable pour piscine enterrée - 4 marches

Scaletta MURO per piscina interrata da 4 gradini – Inox

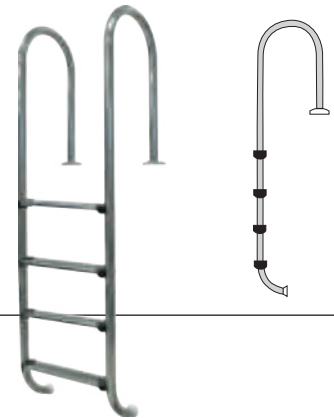

WALL

REF. 40273

BXL PACK 1



Escalera MURO para piscina enterrada de 3 peldaños – Inox

Stainless steel inground pool WALL ladder - 3 steps

Échelle MURALE acier inoxydable pour piscine enterrée - 3 marches

Scaletta MURO per piscina interrata da 3 gradini – Inox

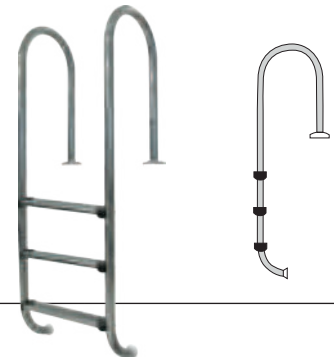

ESCALERA PARA PISCINA DE MADERA WOODEN POOL LADDER
ÉCHELLE POUR PISCINES BOIS SCALETTA PER PISCINE IN LEGNO



Ref. 126674

CBX PACK 1



Escalera de acero inoxidable partida 3 peldaños antideslizantes Para piscinas de madera

Split stainless steel ladder 3 non-slip steps For wooden pools

Échelle en acier inoxydable 2 éléments. 3 marches antidérapantes. Pour piscines en bois.

Scaletta in acciaio inox a due elementi 3 gradini antiscivolo Per piscine in legno



■ complementos ■ complements

ESCALERAS PARA PISCINA SOBRE SUELO ABOVE-GROUND POOL LADDERS
ÉCHELLES POUR PISCINES HORS SOL SCALETTA PER PISCINA FUORI TERRA



INOX
REF. ART1680 BXL PACK 1



Escalera de acero inoxidable 142cm
 2x4 peldaños + plataforma

Stainless steel ladder 142cm
 2x4 steps + platform

Échelle acier inoxydable 142cm
 2x4 marches + plateforme

Scala in acciaio inossidabile 142cm
 2x4 gradini + piattaforma



SAFETY
REF. ES1213 BXL PACK 1



Escalera de seguridad
 2x3 peldaños + plataforma

Safety ladder
 2x3 steps + platform

Échelle sécurité 134cm
 2x3 marches + plateforme

Scala di sicurezza
 2x3 gradini + piattaforma



REF. ET1213 BXL PACK 1



Escalera
 2x3 peldaños

Ladder
 2x3 steps

Échelle
 2x3 marches

Scala
 2x3 gradini



STANDARD

REF. AR109

BXL PACK 1



Escalera tipo tijera 98cm
2x2 peldaños

Ladder 98cm
2x2 steps

Échelle 98cm
2x2 marches

Scala 98cm
2x2 gradini



SPA LADDER

REF. SPAL2

BXL PACK 1



Escalera para SPA
2 peldaños

SPA Ladder
2 steps

Marche pied pour SPA
2 marches

Scala per SPA
2 gradini

70x65x34cm



■ complementos ■ complements

FILTROS DE ARENA SAND FILTERS FILTRE A SABLE FILTRO A SABBIA

Las impurezas quedan retenidas en el medio filtrante en el interior de la cuba. Son muy compactos, fáciles de instalar, utilizar y no requieren especial atención. Gracias a su válvula selectora (5/6 vías dependiendo del modelo), permiten realizar diferentes funciones: autolimpiado, filtración, vaciado... Los filtros FA6100 / FS550 / FS500 / FS400 / FS320 incorporan un prefiltro para retener las partículas excesivamente grandes y evitar dañar la bomba y están certificado con la norma europea EN 16713-1:2015 que garantiza que cumple con las normativas de seguridad establecidas.

Impurities are held by the filter media inside the tank. Sand filters are compact sized, easy to install and use and special care is not required. Thanks to their multiport valves (5/6 ways depending on the version), different functions can be carried out: self-cleaning, filtration, emptying... Filters FA6100 / FS550 / FS500 / FS400 / FS320 are certified with the standard europe EN 16713-1:2015 ensuring that they comply with the safety regulations set. They include a prefilter to hold the largest particles to prevent pump from any damage.

Kits de filtración Filtration kits Kits de filtration Kit di filtrazione



REF. FA6100



REF. FS500



REF. FS400



REF. FS320



W

HP



EAN 13

FA6100

Ø 600 mm

10.000 l/h

485 W

0,66 CV/HP

±130 kg

6

BXL pack 1



FS550

Ø 500 mm

10.000 l/h

750 W

1 CV/HP

±85 kg

5

CBX pack 1



FS500

Ø 500 mm

8.000 l/h

770 W

1 CV/HP

±85 kg

5

CBX pack 1



FS400

Ø 400 mm

6.000 l/h

230 W

0,31 CV/HP

±40 kg

5

CBX pack 1



FS320

Ø 320 mm

4.000 l/h

180 W

0,24 CV/HP

±20 kg

5

CBX pack 1



NEW
2020

■ compléments ■ complementi



Les impuretés sont retenues dans le média filtrant à l'intérieur de la cuve. Ces filtres sont très compacts et très faciles à installer et à utiliser, sans grandes exigences. Sa vanne multivoie (5/6 voies, suivant le modèle), permet de réaliser diverses fonctions: auto nettoyage, filtrage, vidange... Les filtres FA6100 / FS550 / FS500 / FS400 / FS320 sont certifiés par la norme européenne EN 16713-1:2015 garantissant qu'ils respectent les réglementations établies en matière de sécurité. Le filtre est muni d'un pré filtre qui retient les particules excessivement grandes pour éviter d'endommager la pompe.

Le impurità rimangono intrappolate nelle carico filtrante all'interno del cestello. Sono molto compatti, facili da installare e da utilizzare e non richiedono cure particolari. . Grazie alla valvola selettiva della quale sono dotati (5/6/7 uscite a seconda del modello), consentono diverse funzioni: autopulizia, filtrazione, svuotamento... Il filtri FA6100 / FS550 / FS500 / FS400 / FS320 sono certificati dalla normativa europea EN 16713-1:2015 che garantisce la loro conformità alle normative di sicurezza vigenti. Sono composti da un prefiltro per trattenere le particelle eccessivamente grandi ed evitare il danneggiamento della pompa.

Filtro indipendente soplado top Independent top blow molded filters Filtre a sable soufflé en vanne top Filtro soffiato top con valvola superiore



EAN 13

FIS600	Ø 600 mm	12.000 l/h	±85 kg	5	CBX pack 1	 8 412081 305011
FIS500	Ø 500 mm	10.000 l/h	±85 kg	5	CBX pack 1	 8 142081 305004
FIS400	Ø 400 mm	6.000 l/h	±35 kg	5	CBX pack 1	 8 412081 304991

■ complementos ■ complements

BOMBAS PUMPS POMPES POMPE

Gama de bombas autoaspirantes GRE con potencias comprendidas entre 1/3 CV y 2 CV. Se trata de bombas centrifugas de una sola etapa, autocebantes, concebidas para uso con un sistema de filtración de piscina.

The self-priming pump range GRE emits power between 1/3 CV and 2 CV. Centrifugal pumps are single stage, self-priming pumps designed for use in a swimming pool filtration systems.

Gamme de pompes GRE, avec des puissances comprises entre 1/3 CV et 2 CV. Il s'agit de pompes centrifuges, auto-amorçantes, conçues pour une utilisation avec un système de filtration de piscine.

Gamma di pompe autoaspiranti GRE con potenze comprese tra 1/3 CV e 2 CV. Si tratta di pompe centrifughe monostadio, autoadescanti, concepite per l'uso con un sistema di filtrazione per piscina.

PREMIUM

- Ref. PP201 CBX PACK 1
- Ref. PP151 CBX PACK 1
- Ref. PP101 CBX PACK 1
- Ref. PP076H CBX PACK 1



Curvas de rendimiento hidráulico
Hydraulic performance curves
Courbes de performances hydrauliques
Curve delle prestazioni idrauliche

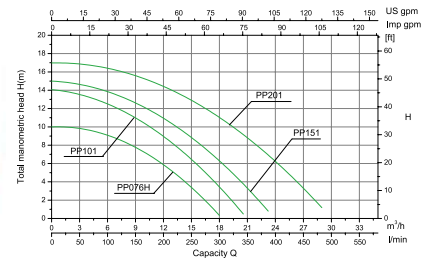

COMFORT

- Ref. PP076 CBX PACK 1
- Ref. PP051 CBX PACK 1
- Ref. PP031 CBX PACK 1



Curvas de rendimiento hidráulico
Hydraulic performance curves
Courbes de performances hydrauliques
Curve delle prestazioni idrauliche

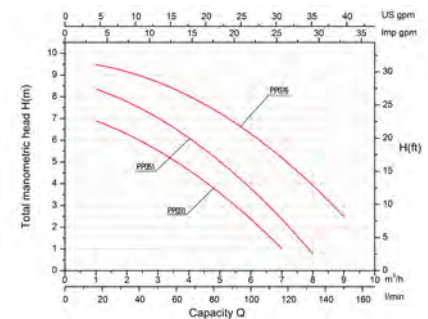

HP

W



EAN 13

Model	Power	W	Flow Rate (l/h)	Capacity (m³)	Ø	Barcode
PP201	2 CV/HP	1600 W	27.000 l/h	170m³	Ø 800 mm	8 412081 269535
PP151	1,5 CV/HP	1100 W	22.000 l/h	135m³	Ø 700 mm	8 412081 269542
PP101	1 CV/HP	900 W	20.000 l/h	100m³	Ø 600 mm	8 412081 269559
PP076H	3/4 CV/HP	600 W	17.000 l/h	65m³	Ø 500 mm	8 412081 302737
PP076	3/4 CV/HP	550 W	9.500 l/h	65m³	Ø 500 mm	8 412081 269566
PP051	1/2 CV/HP	450 W	8.500 l/h	50m³	Ø 400 mm	8 412081 269573
PP031	1/3 CV/HP	250 W	7.000 l/h	35m³	Ø 300 mm	8 412081 269580



FILTRO AQUALOON

REF. FAQ200

CBX PACK 1



FILTRO AQUALOON
Tangue 200 mm. Caudal:
4m³/h. Filtra cualquier residuo
hasta 3 micras.
Conexiones 32 y 38 mm.
Incluye 320g de AquaLoon

AQUALOON FILTER
200 mm tank. Flow rate:
4m³/h. Filters any residue
until 3 micron.
32 and 38 mm connections.
Include 320g AquaLoon

FILTRE AQUALOON
Cuve 200 mm. Débit 4m³/h.
Filtre n'importe quel résidu
jusqu'à 3 microns. Embouts
soudés 32 et 38 mm.
Comprend 320g AquaLoon

SISTEMA FILTRANTE
Filtro 200 mm. Portata
4m³/h.
Filtra qualsiasi residuo fino a
3 micron
Raccordi 32 e 38 mm.
Include 320g di AquaLoon



FILTRO AQUALOON

REF. CFAQ35

CBX PACK 1



FILTRO DE CARTUCHO CON
AQUALOON
Caudal: 3,5m³/h.
Filtra cualquier residuo hasta 3
micras. Conexiones 32 y 38 mm.
Incluye 70g de AquaLoon

CARTRIDGE FILTER
WITH AQUALOON
Flow rate: 3,5m³/h.
Filters any residue until 3
micron.
32 and 38 mm connections.
Include 70g AquaLoon

EPURATEUR À CARTOUCHE
AVEC AQUALOON
Débit 3,5m³/h.
Filtre n'importe quel résidu
jusqu'à 3 microns. Embouts
soudés 32 et 38 mm.
Comprend 70g AquaLoon

FILTRI A CARTUCCIA
Portata 3,5m³/h.
Filtra qualsiasi residuo fino
a 3 micron
Raccordi 32 e 38 mm.
Include 70g di AquaLoon



CARTUCHO AQUALOON

REF. CAQ70

CBX PACK 12



Cartucho AquaLoon tipo A
Cartouche AquaLoon de type A

Type a AquaLoon cartidge
Cartuccia AquaLoon tipo A

MEDIOS FILTRANTES FILTER MEDIA MÉDIAS FILTRANTS CARICO FILTRO



FILTRO AQUALOON

REF. AQ700

CBX PACK 36



REF. AQ700B

CBX PACK 12



MEDIO FILTRANTE
700gr de AQUALOON = 25kg
de ARENA
Filtra cualquier residuo hasta
3 micras
Polietileno 100% reciclable

FILTER MEDIA
700gr AQUALOON = 25kg
SAND. Filters any residue up
to 3 microns
Polyethylene 100% recyclable

MOYEN DE FILTRATION
700g d'AQUALOON = 25kg de
SABLE
Filtre n'importe quel résidu
jusqu'à 3 microns
Polyéthylène 100% recyclable

SISTEMA FILTRANTE
700gr de AQUALOON = 25kg
de ARENA
Filtra qualsiasi residuo fino a 3
micron
Polietilene riciclabile al
100%

LOCALES TÉCNICOS TECHNICAL ROOMS
LOCAL TECHNIQUE LOCALE TECNICO



**DESIGNED,
MACHINED
AND
ASSEMBLED
IN EU**



TECHNICAL ROOM BXL PACK 1

LOCAL TÉCNICO

Pino silvestre autoclave clase III. Paneles pre-ensamblados para montaje por usted mismo. Para todos los tipos de piscinas. Abertura superior mediante trampilla. Para adosar a la piscina o a una pared (con fondo). L. 100 x a. 88 cm - 3 alturas disponibles.

LOCAL TECHNIQUE

En pin Sylvestre autoclave classe III. Panneaux pré-assemblés, à monter soi même. Pour tous types de piscines. Ouverture sur le dessus par une trappe. À adosser à la piscine ou à un mur (avec fond). L. 100 x l. 88 cm - 3 hauteurs disponibles.

TECHNICAL ROOM

Autoclave class III pine. Pre-assembled panels for you to assemble yourself. For all types of swimming pools. Top opening through a flap. To fit to a pool or to a wall (with a base). L. 100 x h 88 cm - 3 heights available.

LOCALE TECNICO

Pino silvestre trattamento in autoclave classe III. Pannelli pre-assemblati che è possibile montare da soli. Per tutti i tipi di piscina. Apertura superiore mediante botola. Da appoggiare alla piscina o a una parete (con fondo). L. 100 x a. 88 cm - 3 altezze disponibili.

Ref. 787247
H. 118cm



3 605217 872470

Ref. 787248
H. 131cm



3 605217 872487

Ref. 787249
H. 143cm



3 605217 872494



**DESIGNED,
MACHINED
AND
ASSEMBLED
IN EU**



80x60x115cm

REF. TRCP124

BXL PACK 1



8 412081 302713

LOCAL TÉCNICO

Local técnico para piscinas de composite en paneles premontados. Candado incluido (para la seguridad de los niños). Mismo diseño y acabado que las piscinas de composite.

LOCAL TECHNIQUE

Local technique pour piscines en composite et panneaux pré-montés. Cadenas inclus (pour la sécurité des enfants). Même style et finition que les piscines en composite.

TECHNICAL ROOM

Composite technical room which consists of pre-mounted panels. A lock is included (as childrens security). Same design and finish as the composite pools.

LOCALE TECNICO

Locale tecnico per piscine in materiale composito a pannelli premontati. Lucchetto incluso (per la sicurezza dei bambini). Design e finitura identiche a quelle della piscina in materiale composito.

MEDIOS FILTRANTES FILTER MEDIA
MÉDIAS FILTRANTS CARICO FILTRO



REF. AR200

PB PACK 1
 PALET 40U.



Arena - Silex 25kg.
 Granulometría 0,4-0,8.

Sand - Silex 25 kg.
 Grain size 0,4-0,8.

Sable - Silex 25kg.
 Granulométrie 0,4-0,8.

Sabbia - Silex 25kg.
 Granulometria 0,4-0,8.



REF. VF025

PB PACK 1
 PALET 40U.



Vidrio filtrante saco 25kg
 Granulometría 0,5 - 1 mm

Glass filter media 25 kg
 Grain size 0,5 - 1 mm

Verre filtrant 25kg
 Granulométrie 0,5 - 1 mm

Vetro filtrante 25kg
 Granulometria 0,5 - 1 mm



Ref. 622564

Palette de 48 sacs



Sable pour Filtration Sac de sable - 25 Kg

Origine France
 Granulométrie : 0,5 à 2 mm
 Sable séché

Remplir la cuve au 3/4 maximum
 Compatible avec tout type de traitement des
 eaux de piscine, y compris la floculation
 Il est conseillé de renouveler le sable tous les 3 ans

Référence exclusive pour la France

■ complementos ■ complements

MANGUERAS DE FILTRACIÓN FILTRATION HOSES TUYAUX POUR ÉPURATEURS TUBI DI FILTRAZIONE

Kit mangueras filtración Filtration hoses kit
 Kit tuyaux pour épurateurs Kit tubi di filtraggio
 2 (Ø38mm x 4,5m) + 1 (Ø38mm x 1,5m) + 1 (Ø38mm x 0,68m)
 + 1 (Ø38mm x 0,58m) + 1 (Ø38mm x 0,40m)
 + 7 abrazaderas / clamps / colliers / fascette



REF. AR2100

BX PACK 1



8 412081 202518

Manguera seccionable Sectionable hose
 Tuyau sectionnable Tubo sezionabile
36,5m - Ø38mm

REF. 90160

BX PACK 1



8 427370 901607

36,5m - Ø32mm

REF. 90161

BX PACK 1



8 427370 901614



Manguera para filtro 4m con 2 terminales Filter hose 4m with 2 cuffs
 Tuyau pour filtration 4m avec 2 embouts Tubo filtrante 4m con 2 terminali

Ø38mm

REF. 40180

BX pack 1



8 427370 401800

Ø32mm

REF. 40181

BX pack 1



8 427370 401817



Manguera de conexión Connection hose
 Tuyau de jonction Tubo di giunzione

68 cm - Ø38mm

REF. 60222

PB pack 10



8 427370 602221

58 cm - Ø38mm

REF. 60218

PB pack 10



8 427370 602184

36 cm - Ø38mm

REF. 60205

PB pack 10



8 427370 602054



ADAPTADORES ADAPTERS
ADAPTEURS ADATTATORI



Adaptador de mangueras Ø32/38mm Ø32/38mm hose bard adaptor
Embout cannelé pour tuyau Ø32/38mm Adattatore per tubo Ø32/38mm

REF. 778196

BX PACK 12



Quitavueltas para manguera Ø38mm Ø38mm hose adaptor with threaded connection
Raccord tournant pour tuyaux Ø38mm Adattatore per tubo Ø38mm

REF. 40091

BX PACK 12



2 conectores Ø38 + 4 abrazaderas Ø38 2 connectors Ø38 + 4 clamps Ø38
2 manchons pour branchement tuyaux Ø38 + 4 colliers Ø38 2 raccordi Ø38 + 4 fascette Ø38

REF. AR509

CS pack 10



2 conectores Ø38/32 + 4 abrazaderas Ø38/Ø32 2 connectors Ø38/32 + 4 clamps Ø38/ Ø32
2 manchons pour branchement tuyaux Ø38/32 + 4 colliers Ø38/Ø32 2 raccordi Ø38/32 + 4 fascette Ø38/Ø32

REF. AR511

CS pack 10

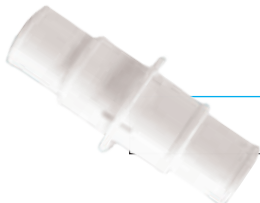

Unión 2 mangueras flotantes Ø38mm y 32mm 2 vacuum hoses union Ø38mm and 32mm
Liaison pour tuyaux flottants Ø38mm et 32mm Raccordo per unire 2 tubi Ø32mm - 38mm

REF. 40009

DIS PACK 12



Adaptador de mangueras 38/32mm 38/32mm hose adapter
Adaptateur de tuyaux Ø38/32mm Adattatore per tubo 32/38mm

REF. 40095

BX PACK 12



■ complementos ■ complements

SKIMMERS PARA PISCINAS DE ACERO STEEL WALL POOLS SKIMMERS SKIMMERS POUR PISCINES PAROI ACIER SKIMMERS PER PISCINA IN ACCIAIO



REF. AR100 BXL PACK 1 8 412081 950396

Skimmer + boquilla de impulsión
Skimmer + buse de refoulement

Skimmer + return fitting
Skimmer + bocchetta



REF. AR100W BXL PACK 1 8 412081 233192

Skimmer + boquilla de impulsión
Skimmer + buse de refoulement

Skimmer + return fitting
Skimmer + bocchetta



REF. AR100G BXL PACK 1 8 412081 271064

Skimmer + boquilla de impulsión
Skimmer + buse de refoulement

Skimmer + return fitting
Skimmer + bocchetta

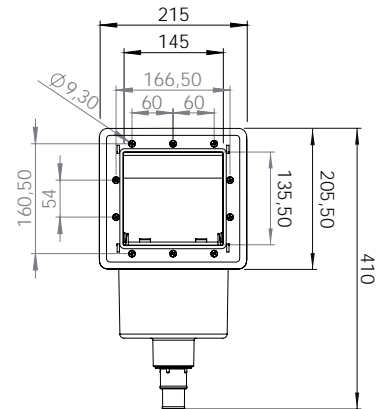

REPUESTOS DE FILTRACIÓN FILTRATION SPARE PARTS ACCESSOIRES POUR FILTRATION RICAMBI PER FILTRAZIONE



REF. AR500
CS PACK 6 8 412081 206462

Cesto para skimmer
Skimmer Basket
Panier pour skimmer
Cesto prefiltrado
Ø ext. 16,2 cm ±5,5 cm Ø int. 11 cm



REF. AR501
CS PACK 6 8 412081 206486

Compuerta para skimmer
Weir for skimmer
Volet pour skimmer
Sportellino
12 x 14,5 x 2 cm



REF. AR502
CS PACK 6 8 412081 206493

Junta doble skimmer
Skimmer layer
Joint pour skimmer
Giunto doppio di stagno
ext. 20,5 x 19,5 x 0,5 cm
int. 14,8 x 13,9 x 0,5 cm



REF. AR521
CS PACK 12 8 412081 250748

Junta doble skimmer + 2 juntas de válvula de retorno
Double seal for skimmer + 2 seals for return valve
Joint double skimmer + 2 joints pour buse de refoulement
Guarnizione doppia standard Skimmer + 2 guarnizioni per la valvola di ritorno



REF. AR503
CS PACK 6 8 4 12081 206509

Boquilla de impulsión
Return fitting
Buse de refoulement
Valvola di impulsione
completa

REF. AR505
CS PACK 8 8 4 12081 208619



Tapa para conexión de
manguera limpiafondos
Lid for connecting the vacuum
hose to the skimmer
Couvercle pour relier le tuyau
flottant au skimmer
Adattatore per puliscifondo



REF. AR506
CS PACK 8 8 4 12081 208602

Manómetro
Pressure gauge
Manomètre
Manometro



REF. AR508
CS PACK 6 8 4 12081 208589

Zuncho universal
Filter ring
Collier de fixation
Ghiera filtro



REF. AR512
CS PACK 12 8 4 12081 221601

Válvula apertura/cierre
Ø38-Ø32
Open/close valve Ø38-Ø32
Vanne ouverture/fermeture
Ø38-Ø32
Valvola di apertura/chisura
Ø38-Ø32



REF. 621702
CBX PACK 12 3 6 05216 217029

Válvula cuarto de vuelta
¼ Turn valve
Vanne ¼ de tour
Valvola ¼ di giro



REF. AR510
CS PACK 24 8 4 12081 215785

Cintaflón y 4 abrazaderas
Cintaflon and 4 clamps
Teflon et 4 colliers
Nastro Teflon e 4 fascette



REF. WFL6
DIS pack 12 8 4 12081 264424

Espojas absorbentes de
grasa - 6 unidades
Grease absorbing sponge for
skimmer - 6 units
Eponges absorbantes de
residus gras - 6 unités
Spugne che assorbe e
trattiene le sostanze grasse
- 6 unità

■ complementos ■ complements

SKIMMER UNIVERSAL UNIVERSAL SKIMMER SKIMMER UNIVERSEL SKIMMER UNIVERSAL

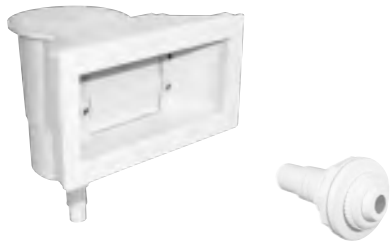

Ref. 778200

BXL PACK 1



Skimmer de boca ancha para piscina de madera + boquilla de impulsión

Wide mouth skimmer for wooden Pool + return valve

Ensemble skimmer grande ouverture piscine bois + buse de refoulement

Skimmer bocca larga piscina Madera + valvola di ritorno



Ref. 778198

BXL PACK 1



Skimmer universal + boquilla de impulsión

Universal Skimmer + return valve

Ensemble skimmer petite ouverture universel + buse de refoulement

Skimmer universale + valvola di ritorno



Ref. 778193

CS PACK 12



Compuerta para skimmer
Weir for skimmer
Volet pour skimmer
Sportellino



Ref. 625028

CB PACK 12



Tapa para skimmer
Cover for skimmer
Couvercle pour skimmer
Lid per skimmer



Ref. 778194

CS PACK 6



Cesto para skimmer
Skimmer Basket
Panier pour skimmer
Cesto prefiltro
Dim. Ext. Ø16cm/ Int. Ø12 cm - H.7,5 cm



Ref. 770359

CB PACK 12



Tapa para conexión de manguera limpiafondos
Lid for connecting the vacuum hose to the skimmer
Couvercle pour relier le tuyau flottant au skimmer
Adattatore per puliscifondo
Ø 32/38 mm



Ref. FSK10

DIS pack 12



Filtros de skimmer con velcro
Prefiltres jetables de skimmer avec velcro.
Pre-filter fabric bag for use in skimmer using velcro
Filtri di skimmer con velcro
10 u.



Ref. 40045

CS PACK 12



10 filtros de skimmer
10 filter savers
10 filtres pour skimmer
10 filtri di skimmer



FILTROS DE CARTUCHO CARTRIDGE FILTER
EPURATEUR À CARTOUCHE FILTRI A CARTUCCIA

Están especialmente concebidos para piscinas con un volumen de agua medio-inferior. Son muy sencillos de utilizar y su mantenimiento se limita a la limpieza o sustitución del cartucho o filtro de recambio, cuando éste ha quedado obstruido por la excesiva carga de suciedad.

Ils sont spécialement conçus pour les piscines d'un volume d'eau moyen inférieur. Ils sont très faciles à utiliser et l'entretien se limite au nettoyage ou au remplacement de la cartouche ou du filtre, quand il est bouché par un excès de saletés.

Specially designed for medium-low water volume pools. Cartridge filters are very easy to use and their maintenance is limited to the cartridge cleaning or replacement when dirt is blocking it.

Pensati specialmente per piscine con un volume di acqua medio-basso. Sono molto semplici da usare e la manutenzione si limita alla pulizia o sostituzione della cartuccia o della cartuccia di ricambio, quando questa è ostruita da eccessive impurità.



REF. AR125



REF. AR124
REF. AR121E



W



EAN 13

AR125	3.800 l/h	70 W	AR82	BXL pack 1	8 4 1 2 0 8 1 9 7 0 3 1 8
AR124	3.800 l/h	70 W	AR82	BXL pack 1	8 4 1 2 0 8 1 2 0 3 1 6 4
AR121E	2.000 l/h	72 W	AR86	BXL pack 1	8 4 1 2 0 8 1 2 1 0 1 9 3

CARTUCHOS CARTRIDGES CARTOUCHES CARTUCCIA



REF. AR79

Cartucho tipo A piscina autoportante
 Type A Cartridge inflatable pool
 Cartouche de type A piscine autoportante
 Cartuccia tipo A piscina autoportante



REF. AR86

Cartucho
 Cartouche
 Cartridge
 Cartuccia



EAN 13

AR86	AR121/118	CS pack 12	8 4 1 2 0 8 1 2 0 3 4 0 9
AR82	AR125/124/118	CS pack 12	8 4 1 2 0 8 1 9 7 0 3 2 5
AR89	AR11806	CS pack 12	8 4 1 2 0 8 1 2 1 7 0 1 7
AR79	Type A	PB pack 18	8 4 1 2 0 8 1 2 4 1 7 0 8

■ complementos ■ complements

ANALIZADOR INTELIGENTE PARA LA PISCINA SMART POOL ANALYSER
ANALYSEUR INTELLIGENT POUR LA PISCINE ANALIZZATORE INTELLIGENTE
PER PISCINA



blue connect Go

REF. 73014 CBX PACK 1



Sensor innovador todo en uno
 Mide los principales parámetros de la piscina: Temperatura, pH, Nivel desinfectante (ORP).

Innovative all-in-one sensor
 Measure main parameters of pools: Temperature, pH, Disinfectant level (ORP).

Capteur innovant tout en un
 Mesure les principaux paramètres de la piscine: température, pH, niveau désinfectant (ORP).

Innovativo sensore tutto in uno
 Misura i principali parametri della piscina: Temperatura, pH, livello disinfettante (ORP).

REF. 7015C001
 BXL PACK 1



Batería para el Blue Connect. Batería de litio de cloruro de tionilo.
 Battery for the Blue Connect. Lithium thionyl chloride battery.
 Batterie pour le Blue Connect. Batterie en lithium-chlorure de thionyle.
 Batteria per il Blue Connect. Batteria al litio cloruro di tionile

REF. 7015R001
 BXL PACK 1



Blue Sensor es un sensor compatible con Blue Connect con vida útil de 2 temporadas
 Blue Sensor is compatible with Blue Connect with a useful life of 2 seasons
 Blue Sensor est un capteur compatible avec le Blue Connect dont la durée de vie est de 2 saisons.
 Blue Sensor è un sensore compatibile con Blue Connect con vita utile pari a 2 stagioni



REF. 7015R002
 BXL PACK 1



Blue Sensor Au (oro) especial electrólisis.
 Blue Sensor Au (gold) special for salt chlorinator.
 Blue Sensor Au spécial pour électrolyse au sel
 Blue Sensor Au (oro) speciale per elettrolisi salina

REF. 7015C004
 BXL PACK 1



Puente wifi bluetooth
 Bluetooth WiFi bridge
 Amplificateur Wi-Fi Bluetooth
 Connessione wifi bluetooth

■ compléments ■ complementi



REF.
7015C002
BXL PACK 1



NEW
2020

Blue Fit 50: adaptador tubería 50mm.
Blue Fit 50: 50mm tapping saddle.
Blue Fit 50: Adaptateur de tuyau 50mm.
Blue Fit 50: Adattatore per tubo da 50 mm



REF. 71666
BXL PACK 1



Kit de calibrado.
Blue calibration kit.
Kit de calibration.
Kit di calibrazione.



Blue Check
BXL PACK 144



REF. 71664
(EN/FR/DE/NL)

Tiras de prueba para analizar la calidad del agua de la piscina
After test to analyse water quality of the pool



REF. 71665
(EN/ES/IIT/PT)

Bandelettes d'analyse pour analyser la qualité de l'eau de la piscine.
Strisce di prova per analizzare l'acqua della piscina

ELECTROLISIS DE SAL SALT CHLORINATOR ELECTROLYSE AU SEL ELETTRILISI SALINA

Los cloradores por electrolisis de sal generan cloro para la desinfección de la piscina a partir de sal. La electrolisis de sal tiene varias ventajas: genera y dosifica automáticamente el cloro en la piscina, evita el almacenamiento y la manipulación de producto químico y es totalmente seguro, ya que sólo utiliza sal común.

Les chlorinateurs par électrolyse au sel génèrent du chlore pour la désinfection de la piscine grâce au sel. L'électrolyse au sel présente plusieurs avantages : Elle génère et dose automatiquement le niveau de chlore dans la piscine, évite le stockage et la manipulation de produits chimiques et est complètement sûre, étant donné qu'elle n'emploie que du sel commun.

Through electrolysis of salt, the chlorinators generate chlorine and salt to disinfect the swimming pool. The electrolysis of salt has various advantages: Generating and automatically dosing the chlorine in the swimming pool, avoids the handling and storage of chemical products and it completely safe, using only sodium chloride.

I clorinatori per elettrolisi salina producono cloro per la disinfezione della piscina partendo dal sale. L'elettrolisi salina ha diversi vantaggi: produce e provvede al dosaggio automatico del cloro nella piscina, evita l'immagazzinamento e l'uso di prodotti chimici ed è del tutto sicura in quanto fa uso del sale comune.

GRE SALT SYSTEM

REF. SCGPH100 BXL PACK 1



Hasta 100m³
Producción de cloro: 21 g/h
Electrolisis de sal + Controlador de pH + Bomba dosificadora

Jusqu'à 100m³
Production de chlore: 21 g/h
Electrolyse au sel + Contrôleur de pH + Pompe doseuse

Until 100m³
Chlorine production: 21 g/h
Salt chlorinator + pH control + Dosing pump

Fino a 100m³
Produzione di cloro: 21 g/h
Elettrolisi salina + Regolatore di pH + Pompa per il dosaggio del prodotto chimico



NEW
2020

■ complementos ■ complements

PARA PISCINAS ELEVADAS Y ENTERRADAS FOR ABOVE GROUND AND IN GROUND POOLS POUR PISCINES ENTERRÉES ET HORS SOL PER PISCINE INTERRATE E FUORI TERRA

GRE SALT SYSTEM

REF. SCG100 BXL PACK 1



Hasta 90m³
Producción de cloro: 21 g/h
Jusqu'à 90m³
Production de chlore: 21 g/h

Until 90m³
Chlorine production: 21 g/h
Fino a 90m³
Produzione di cloro: 21 g/h

REF. SCG60

BXL PACK 1



Hasta 60m³
Producción de cloro: 12 g/h
Jusqu'à 60m³
Production de chlore: 12 g/h

Until 60m³
Chlorine production: 12 g/h
Fino a 60m³
Produzione di cloro: 12 g/h



GRE SALT SYSTEM + CPH14

REF. SCGPH100 BXL PACK 1



Electrolisis de sal + controlador de pH
Hasta 90m³
Producción de cloro: 21 g/h

Salt chlorinator + pH-control
Until 90m³
Chlorine production: 21 g/h

Electrolyse au sel contrôleur de pH
Jusqu'à 90m³
Production de chlore: 21 g/h

Elettrolisi salina + regolatore di pH
Fino a 90m³
Produzione di cloro: 21 g/h



REF. SCGPH60

BXL PACK 1



Electrolisis de sal + controlador de pH. Hasta 60m³
Producción de cloro: 12 g/h

Salt chlorinator + pH-control
Until 60m³
Chlorine production: 12 g/h

Electrolyse au sel contrôleur de pH. Jusqu'à 60m³
Production de chlore: 12 g/h

Elettrolisi salina + regolatore di pH
Fino a 60m³
Produzione di cloro: 12 g/h



GRE BALANCE

REF. EESB55 CBX PACK 1



Hasta 55m³
Producción de cloro: 8 g/h
Fácil instalación, sin mantenimiento
Jusqu'à 55m³
Production de chlore: 8g/h
Facile à installer, sans maintenance

Until 55m³
Chlorine production: 8 g/h
Easy installation, maintenance free
Fino a 55m³
Produzione di cloro: 8 g/h
Semplice da installare, non necessita di manutenzione



SAL ESPECIAL PARA PISCINA POOL SALT
SEL SPÉCIAL PISCINE SALE PER PISCINE



REF. 90365

PB PACK 1
 PALET 40U.



Sal compacta
 saco 25kg
 Sel compacté
 sac 25kg

Compact salt
 bag 25kg
 Sale compatto
 25kg

REF. AR2000

BXL PACK 1



Kit Bypass
 Contiene: 3 Válvulas apertura/cierre + 2 mangueras Ø38 mm x 1,5 m + 6 piezas de reducción Ø38 - 50 mm para encolar + 4 abrazaderas

Bypass kit
 Contains: 3 opening/closing valves + 2 hoses Ø38 mm x 1,5 m + 6 reduction parts Ø38 - 50 mm to glue + 4 lamps

Kit Bypass
 Comprend: 3 vannes ouverture / fermeture + 2 tuyaux Ø38 cm x 1,5 m + 6 pièces réduction Ø38 - 50 mm à coller + 4 colliers

Kit Bypass
 Contiene: 3 valvole di apertura/chiusura + 2 tubi flessibili Ø38 cm x 1,5 m + 6 pezzi adattatori Ø38 - 50 mm da incollare + 4 fascette

BOMBA DOSIFICADORA Y CONTROLADOR POOL DOSING SYSTEMS
CONTRÔLEUR ET DOSEUSE REGULATORE E DOSATORE



REF. CPH14

BXL PACK 1



El controlador de pH con bomba peristáltica para piscina enterrada automatiza la regulación del pH, lo que permite estabilizar el pH en el valor ideal para su confort y optimizar la eficacia del tratamiento de desinfección.

pH-Control dosing system is a peristaltic pump designed to maintain a chosen pH level on inground pools, allowing stabilize the pH in the ideal value for comfort and to optimize the efficiency of the disinfection treatment.

Le contrôleur de pH avec pompe péristaltique pour piscine enterrée automatise la régulation du pH, ce qui permet de stabiliser le pH sur la valeur idéale pour votre confort et optimiser l'efficacité du traitement de désinfection.

Il regolatore di pH con pompa peristaltica per piscine interrata automatizza la regolazione del pH consentendo di stabilizzarlo su un valore ideale e ottimizzando l'efficacia del trattamento di disinfezione.



REF. BDP4

BXL PACK 1



Bomba dosificadora peristáltica. Caudal variable 4 l/h y 1,5 Bar. Permite dosificar el producto químico de forma fácil y segura.

Peristaltic dosing pump. Variable flow rate. 4 l/h and 1,5 Bar. Safe and easy way of dosing of the chemical product UV-C.

Pompe doseuse péristaltique. Vitesse variable 4l/h et 1,5 bar. Permet le dosage de produit chimique de façon facile et précise.

Pompa per il dosaggio del prodotto chimico. Pressione variabile 4 l/h e 1,5 Bar

DEPORTE EN LA PISCINA POOL FITNESS
FITNESS PISCINE FITNESS IN PISCINA



AQUABIKE
REF. AQB2

CBX PACK 1



BICICLETA ACUÁTICA

Una nueva forma de hacer ejercicio en bicicleta cuando estás en la piscina. Concebido para todo tipo de piscinas. Sillón anatómico - Manillar deportivo - Ruedas antiarañazos - Pedales anatómicos con resistencia ajustable.

WATER BIKE

A new way of exercising by cycling when you are in the pool. Conceived for all type of pools. Anatomic saddle - Sporting handle bar - Anti scratch wheels - Anatomic pedals with adjustable resistance.

VÉLO DE PISCINE

Une nouvelle façon de faire de l'exercice à vélo lorsque vous êtes dans la piscine. Conçu pour tous les types de piscines. Selle anatomique - guidon sportif - roues anti-rayure pour un transport facile - Pédales anatomiques avec résistance réglable.

BICICLETTA ACQUATICA

Un nuovo modo di allenarsi in bici quando si è in piscina. Progettato per tutti i tipi di piscine. Sellino anatomico - manubrio sportivo - ruote antigraffio per facilitare il trasporto - Pedali anatomici con resistenza regolabile.



POOL ATHLETE
REF. PTR84

CBX PACK 1



Nueva manera revolucionaria de mantenerse en forma en la piscina. Diseño especial para piscinas sobre el suelo. También apto para piscinas enterradas. Nouvelle manière révolutionnaire de rester en forme dans la piscine. Design special pour piscines hors sol et enterrées.

New revolutionary way to keep fit in the pool. Special design for above ground pools. Also suitable for in-ground pools. Nuovo modo rivoluzionario per mantenersi in forma in piscina. Speciale design per piscine fuori terra. Adatto anche per piscine interrato.

SEGURIDAD PISCINA POOL SECURITY
PROTECTION POUR PISCINE PROTEZIONE PER PISCINE



REF. SF133

CBX PACK 1



Barrera de protección para piscinas.

Módulo premontado. Longitud adaptable. Adaptable a diferentes formas de piscina. Módulo de 3 m de uso individual. Altura de la barrera: 1,33 m. Tejido efecto transparente que permite una visibilidad excelente de la piscina.

Barrière de protection pour piscine.

Module pré-monté. Adaptable en longueur pour répondre à toutes les configurations. Module de 3m à usage individuel. Hauteur de la barrière : 1,33m. Toile effet «transparent» qui permet une excellente visibilité du bassin. Conforme à la norme NF P 90-306

Safety fence for swimming pool.

Ready to install. Adjustable in length to answer all configurations. 3 m module for individual use. Fence height : 1,33m. Transparent net witch allows an excellent visibility of the swimming pool.

Barriera di protezione per piscine.

Modulo pre installato. Lunghezza adattabile in base alle forme della piscina. Modulo di 3m ad uso individuale. Altezza della barriera: 1,33 m. Tessuto effetto trasparente che permetta una visibilità eccellente della vasca.

REF. 770270

CBX PACK 1



Alarma de piscina

Vigilancia máxima. Detector de inmersión certificado DE CONFORMIDAD con la norma NF P90 307/A1 por el LNE. Sin activación imprevista. Se coloca en modo vigilancia automática 15 minutos después del baño. Información permanente sobre el estado de la vigilancia.

Alarme de piscine

Surveillance maxi. Détecteur d'immersion certifié CONFORME à la norme NF P90 307/A1 par le LNE. Aucun déclenchement intempestif. Remise en surveillance automatique 15 minutes après la baignade. Information permanente sur l'état de surveillance.

Pool alarm

Maximum surveillance. Immersion detector with CONFORMITY certificate with the NF P90 307/A1 Standard by LNE. Without unexpected activation. Automatically enters into surveillance mode 15 minutes after the last use of the pool. Permanent information about the surveillance status.

Allarme per piscina

Massimo livello di vigilanza. Rilevatore di immersione certificato IN CONFORMITÀ con la normativa NF P90 307/A1 dell'LNE. Senza attivazione imprevista. Si posiziona in modalità di vigilanza automatica 15 minuti dopo l'utilizzo della piscina. Informazione permanente sullo stato di vigilanza.



■ complementos ■ complements

ILUMINACIÓN PARA PISCINAS ENTERRADAS IN GROUND POOLS LIGHTING ÉCLAIRAGE POUR PISCINES ENTERRÉES ILLUMINAZIONE PER PISCINE INTERRATE

REF. PLCH144 BL PACK 1



Proyector 144 LEDs
COLOR (RGB) piscina
enterrada de HORMIGÓN.
Projecteur de 144 LEDS de
COULEUR pour
piscine enterrée BÉTON.

Projector with 144 LEDs,
colour RGB for CONCRETE
pools.
Faretto Ø 28 x 7, 144
LED MULTICOLOR RGB,
per piscine interrate in
MURATURA



REF. PLCL144 BL PACK 1



Proyector 144 LEDs
COLOR (RGB) piscina
enterrada de LINER.

Projecteur de 144 LEDS de
COULEUR
pour piscine enterrée avec
LINER.

Projector with 144 LEDs,
colour RGB for LINER pools.
Faretto Ø 28 x 7, 144 LED
MULTICOLOR
RGB, per piscine interrate
con LINER.

REF. PLBH144 BL PACK 1



Proyector 144 LEDs blanco
piscina enterrada de
HORMIGÓN.

Projecteur de 144 LEDS
BLANCHES pour piscine
enterrée BÉTON.

Projector with 144 white
LEDs for CONCRETE pools

Faretto Ø 28 x 7, 144 LED
color BIANCO, per piscine
interrate in MURATURA.



REF. PLBL144 BL PACK 1



Proyector 144 LEDs
BLANCO piscina
enterrada de LINER.

Projecteur de 144 LEDS
BLANCHES pour piscine
enterrée LINER.

Projector with 144 WHITE
LEDs for LINER in-ground
pools.

Faretto Ø 28 x 7, 144 LED
color BIANCO, per piscine
interrate con LINER.

PISCINAS ENTERRADAS Y PISCINAS MADERA IN GROUND AND WODDEN POOLS POUR PISCINES ENTERRÉES ET BOIS PER PISCINE INTERRATE ED IN LEGNO

REF. PLREB BXL PACK 1



Proyector LED BLANCO
para piscina enterrada y
de madera
Projecteur LED BLANCHE
pour piscine enterrée et
bois

WHITE LED projector
for in-ground and
wodden pools
Faretto LED BIANCO
per piscina interrata e
in legno

REF. PLREC BXL PACK 1



Proyector LED COLOR
para piscina enterrada y
madera.
Con control remoto

Projecteur LED de
COULEUR pour piscine
enterrée et bois.
Avec télécommande.

COLOR LED projector for
in-ground and wooden
pools.
With remote control.

Faretto LED MULTICOLOR
per piscina interrata e in
legno.
Include telecomando.



NEW
2020



REF. LEDP56WE

CBX PACK 1



8 412081 304939

Lámpara LED BLANCA PAR56.
Muy fácil instalación 100%
fabricada en EU (fábrica propia).
Los LED e ofrecen una vida útil
de 25000h.

Ampoule LED BLANCHE
PAR56.

Très facile à installer 100%
fabriquée en Europe (usine
propre). Les ampoules offrent
une durée de vie de 25 000 h.

PAR56 WHITE LED lamp
Easily installed lamp. 100%
manufactured in EU (own
production). LED has a useful
life of 25,000 h.

Lampada PAR56 LED BIANCA.
Lampada di semplicissima
installazione, prodotta al 100%
in EU (produzione propria).
Offre una durata utile di
25.000 ore.

NEW
2020



REF. LEDP56CE

CBX PACK 1



8 412081 304946

Lámpara LED COLOR PAR56.
Muy fácil instalación 100%
fabricada en EU (fábrica propia).
Los LED e ofrecen una vida útil de
25000h.

Ampoule LED COULEUR PAR56.

Très facile à installer 100%
fabriquée en Europe (usine
propre). Les ampoules offrent
une durée de vie de 25 000 h.

PAR56 COLOUR LED lamp.
Easily installed lamp. 100%
manufactured in EU (own
production). LED has a useful
life of 25,000 h

Lampada LED COLOR PAR56.
Lampada di semplicissima
installazione, prodotta al 100%
in EU (produzione propria).
Offre una durata utile di
25.000 ore.



REF. 40710

BX PACK 6



8 427370 407109

Bombilla
proyector.
Ampoule
projecteur.

300w
300w

para
pour

300w bulb for underwater
light.
Lampada 300w per faro.

ILUMINACIÓN PARA PISCINAS SOBRE SUELO ABOVE GROUND POOLS
LIGHTING ÉCLAIRAGE POUR PISCINES HORS SOL ILLUMINAZIONE PER
PISCINE FUORI TERRA

REF. PLWPB

CBX PACK 4



Proyector led blanco **para piscinas de madera y composite**

Led de bajo consumo. Potencia 16w. Fácil instalación. Ofrecen una vida útil entre 50.000 y 100.000 horas. Gran calidad: Fabricado en Europa. Incluye 5m de cable + transformador.

Projecteur led blanc **pour piscines en bois et composite.** Led à basse consommation. Puissance 16w. Facile à installer. Durée de vie : de 50 000 à 100 000 heures. Grande qualité: Fabriqué en Europe. Comprend: 5m câble + transformateur.

White LED projector **for wooden and composite pools.** Low consumption LED. Power: 16 W. Easy installation, since a standard plug is included Long life: 50.000 to 100.000 hours. High quality: Made in Europe. 5m wire + transformer included.

Proiettore a led di colore bianco **per piscine in legno e in materiale composito.** Led a basso consumo Potenza 16w. Semplice da installare. Offrono una vita utile compresa tra 50.000 e 100.000 ore. Qualità elevata: Prodotto in Europa. 5m cavo + transformador.



REF. LEDRW

CBX PACK 12



Proyector LED BLANCO de alto rendimiento para conectar a la válvula de retorno. Adaptable a piscinas elevadas tanto autoportantes como de pared rígida. Caudal mínimo necesario: 3.000 l/h. Funciona sin necesidad de batería.

Projecteur LED BLANCHE à haut rendement pour connecter à la buse de refoulement. Adaptable à des piscines hors-sol, aussi bien autoportantes qu'avec des parois rigides. Débit minimum nécessaire : 3 000 l/h. Fonctionne sans nécessité de batterie.

WHITE LED projector for connecting to the return valve. Adaptable for movable above ground pools with rigid walls. High performance WHITE LEDs. Generates light at no cost, does not need batteries. Minimal flow needed: 3000 l/h

Proiettore LED BIANCO a resa elevata per connessione alla valvola di ritorno. Si adatta a piscine fuori terra, sia autoportanti che a parete rigida. Flusso minimo necessario: 3.000 l/h. Funziona senza batteria.



REF. LEDRC

CBX PACK 12



Proyector LED COLOR de alto rendimiento para conectar a la válvula de retorno. Adaptable a piscinas elevadas tanto autoportantes como de pared rígida. Caudal mínimo necesario: 3.000 l/h. Funciona sin necesidad de batería.

Projecteur LED COULEUR à haut rendement pour connecter à la buse de refoulement. Adaptable à des piscines hors-sol, aussi bien autoportantes qu'avec des parois rigides. Débit minimum nécessaire : 3 000 l/h. Fonctionne sans nécessité de batterie.

COLOUR LED projector for connecting to the return valve. Adaptable for movable above ground pools with rigid walls. High performance COLOUR LEDs. Generates light at no cost, does not need batteries. Minimal flow needed: 3000 l/h

Proiettore LED COLOR a resa elevata per connessione alla valvola di ritorno. Si adatta a piscine fuori terra, sia autoportanti che a parete rigida. Flusso minimo necessario: 3.000 l/h. Funziona senza batteria.



Ref. PLPB14

CBX PACK 1



8 412081 268439



Projector LED BLANCO para conectar a la válvula de retorno. Hasta un 90% de ahorro de energía. Vida útil de 50,000h. 1.600 lumens.

WHITE LED projector to connect to the return valve. Up to 90% energy saving. Useful life of 50,000h. 1.600 lumens.

Projecteur LED BLANCHE pour connecter à la buse de refoulement. Jusqu'à 90% d'économie d'énergie. Durata utile di 50,000H. 1.600 lumens durée de vie.

Proiettore LED BIANCO per connessione alla valvola di ritorno. Fino al 90% di risparmio di energia. Durata utile di 50.000 ore. 1.600 lumens.

REF. PLEDIC

BL PACK 6



8 412081 257518



Projector LED COLOR para piscina elevada de acero. Fácil instalación, se pega a la chapa mediante un imán. Incorpora mando a distancia para fácil manejo. Tecnología Led de bajo consumo.

COLOR LED projector for above ground pools. Stick to the sheet with a magnet and ready to use. Includes remote control for easy operation. Energy-saving LED technology.

Projecteur LED de COULEUR pour piscine hors sol. Ils sont spécialement conseillés pour les piscines hors sol en tôle. Se fixe simplement sur la tôle grâce à un aimant. Ils sont livrés avec une télécommande très simple à utiliser. Technologie LED à faible consommation.

Faretto LED MULTICOLOR per piscina fuoriterra. Foglio adesivo con un magnete pronto all'uso. Include telecomando a distanza per un facile funzionamento. Risparmio energetico tecnologia al LED.

REF. PLED2

CS PACK 4



8 412081 250830



Conjunto de 2 proyectores LED BLANCOS para piscina elevada de acero. Fácil instalación, se pega a la chapa mediante un imán. Incorpora mando a distancia para fácil manejo. Tecnología Led de bajo consumo.

Set of 2 WHITE LED projectors for above ground pools. Stick to the sheet with a magnet and ready to use. Includes remote control for easy operation. Energy-saving LED technology.

Ensemble de 2 projecteurs LED pour piscine hors sol. Ils est spécialement conseillé pour les piscines hors sol en tôle. Se fixe simplement sur la tôle grâce à un aimant. Ils sont livrés avec une télécommande très simple à utiliser. Technologie LED à faible consommation.

2 Faretto LED per piscina fuoriterra. Foglio adesivo con un magnete pronto all'uso. Include telecomando a distanza per un facile funzionamento. Risparmio energetico tecnologia al LED.

REF. 90173

CBX PACK 6



8 427370 901737

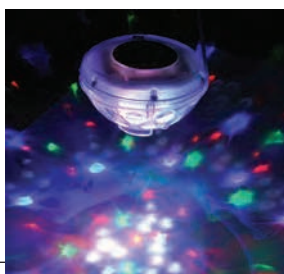

Lámpara fantasía 7 programas de luz diferentes.

Fancy lamp 7 different lighting programmes.

Lampe fantasie sept jeux de lumière sur les parois et le fond de la piscine.

Lampada fantasia sette giochi di luce differenti ai lati della piscina e sul fondo.

■ complementos ■ complements

CALEFACCIÓN HEATING SYSTEMS CHAUFFAGE RISCALDAMENTO

La bomba de calor es el método más eficiente para calentar una piscina y además permite alargar la temporada de baño.

Las bombas de calor mueven la energía térmica en la dirección opuesta a la transferencia de calor espontánea, al absorber el calor de un espacio frío y liberarlo a uno más cálido.

La pompe à chaleur est la méthode la plus efficace pour chauffer une piscine, et permet en outre d'allonger la saison des baignades.

Les pompes à chaleur déplacent l'énergie thermique dans le sens opposé au transfert de chaleur spontanée, en absorbant la chaleur d'un espace froid et en la libérant dans un espace plus chaud.

The heat pump is the most efficient method for heating a pool and in addition allows extending the bathing season

Heat pumps move thermal energy in the opposite direction to spontaneous heat transfer, by absorbing heat from a cold space and releasing it into a hotter one.

La pompa di calore rappresenta il metodo più efficace per riscaldare la piscina e consente di utilizzarla tutto l'anno.

Le pompe di calore muovono l'energia termica in direzione opposta rispetto al trasferimento spontaneo di calore, assorbendo calore da uno spazio freddo e rilasciandolo in uno più caldo.

BOMBAS DE CALOR MINI PARA PISCINAS SOBRE SUELO ABOVE GROUND POOLS MINI HEAT PUMPS POMPES À CHALEUR MINI POUR PISCINES HORS SOL POMPA DI CALORE MINI PER PISCINE FUORI TERRA

MINI HEAT PUMPS

REF. HPM30 BXL PACK 1



Bomba de calor Mini para pequeño volumen de agua: hasta 30m³. No necesita bypass. Conexiones 32 y 38 mm.

Mini heat pumps for reduced water volumes: up to 30 m³. Bypass not necessary. 32 and 38 mm connections.

Pompe à chaleur Mini pour petit volume d'eau: jusqu'à 30m³. Elle n'a pas besoin de bypass. Embouts soudés 32 et 38 mm.

Pompa di calore Mini per piscine a ridotto volume di acqua: fino a 30m³. Non ha bisogno di un bypass. Raccordi 32 e 38 mm.

REF. HPM20 BXL PACK 1



Bomba de calor Mini para pequeño volumen de agua: hasta 20m³. No necesita bypass. Conexiones 32 y 38 mm.

Mini heat pumps for reduced water volumes: up to 20 m³. Bypass not necessary. 32 and 38 mm connections.

Pompe à chaleur Mini pour petit volume d'eau: jusqu'à 20 m³. Elle n'a pas besoin de bypass. Embouts soudés 32 et 38 mm.

Pompa di calore Mini per piscine a ridotto volume di acqua: fino a 20m³. Non ha bisogno di un bypass. Raccordi 32 e 38 mm.



Configurador de bombas de calor
Encuentra la bomba de calor ideal para tu piscina.

Heat pump configuration
Find the ideal heat pump for your pool.

Configurateur de pompes à chaleur
Trouver le modèle le plus adapté à votre piscine

Configuratore di pompa di calore
Trova la pompa di calore ideale per la tua piscina



Más información sobre las bombas mini en el siguiente video.

More information about heat pumps in the following video.

Plus d'informations sur les pompes Mini dans la vidéo suivante.

Maggiori informazioni sulle pompe di calore sono disponibili nel video riportato a continuazione.

BOMBAS DE CALOR GRE
GRE HEAT PUMPS
POMPES À CHALEUR GRE
POMPA DI CALORE GRE



Volumen max. Volume max	Max. volume Volume massimo	15 m ³	30 m ³	60 m ³	80 m ³	120 m ³
Referencia Référence	Reference Codice articolo	777590	777591	778375	778392	778393
Temperatura min/max Plage fonctionnement	Min/max temperature Temperature min.max	- 5 + 43 °C	- 5 + 43 °C	- 5 + 43 °C	- 5 + 43 °C	- 5 + 43 °C
Potencia calorífica Puissance de chauffage	Heating power Potenza di riscaldamento	3,5 kW	5 kW	8,5 kW	11,5 kW	24 kW
COP COP	COP COP	5,8 W/W	5,32 W/W	5,59 W/W	5,6 W/W	5,85 W/W
Potencia enfriamiento Puissance refroidissement	Coolness power Potenza di raffreddamento	2,3 kW	3,7 kW	6,0 kW	8,2 kW	16,5 kW
Potencia de absorción Puissance absorbée	Absorption power Potenza assorbimento	0,6 kW	0,94 kW	1,52 kW	2,07 kW	4,1 kW

Compresor de rotación Hitachi. Rotation compressor of Hitachi.
 Compreseur à rotation Hitachi. Compresore di rotazione Hitachi

Carga Charge	Charge Peso	400 g	620 g	900 g	1000 g	2200 g
Alimentación eléctrica monofásica Alimentation électrique monophasée	Electrical source power single-phase Alimentazione elettrica monofase	220-240 V / 50 Hz / 1 PH				
Conexión eléctrica Raccordement électrique	Electrical connection connessione elettrica	Toma tierra earth ground Avec terre messa a terra	Diferencial (no incluido) Diferential (not included) Boîte de dérivation (non fournie) differenziale(non incluso)			
Resistencia titanio Résistance en titane	Titanium resistance Resistenza in titanio	Titanio Titanium Titane Titanio				
Flujo de salida mínimo Débit minimum à la sortie	Minimal flow of exit Flusso minimo in uscita	2,5m ³ /h	2,8m ³ /h	5,2m ³ /h	6,9m ³ /h	12m ³ /h
Conex Raccords	Conexión Connessione	50 mm				
Nivel de ruido del 1 al 10 Niveau sonore de 1 à 10 m	Sound level from 10m to 1m Livello sonoro da 1 a 10	35/42 dB(A)	35/44 dB(A)	36/45 dB(A)	36/45 dB(A)	47/56 dB(A)

Visualización de los parámetros de funcionamiento por pantalla LED. Display of operating parameters through LED screen.
 Affichage des paramètres de fonctionnement par écran LED. Visualizzazione dei parametri di funzionamento mediante LED

Medida producto Dimensions l'appareil	Product size Misura prodotto	751 x 300 x 502 mm	751 x 300 x 502 mm	930 x 360 x 550 mm	1000 x 360 x 620 mm	1045 x 410 x 855 mm
Medida con caja Dimensions du carton	Packaging size Misura imballaggio	850 x 530 x 330 mm	855 x 530 x 330 mm	1060 x 600 x 380 mm	1065 x 670 x 380 mm	1140 x 955 x 430 mm
Peso neto/bruto Poids net/brut	Net/brut weight Peso net/brut	32/37 kg	37/42 kg	50/56 kg	65/72 kg	110/117 kg

Código EAN
Gencod

EAN Code
Codice a barrie



CALEFACCIÓN SOLAR SOLAR HEATING SYSTEM
CHAUFFAGE SOLAIRE RISCALDAMENTO SOLARE



Sistemas para calentamiento del agua de la piscina mediante la acción solar. Solar pool water heating systems. Chauffage solaire pour piscine. Fabriqué en polyéthylène. Sistema per il riscaldamento dell'acqua della piscina per mezzo dell'azione del sole.



REF. AR2069 CBX PACK 1



Fabricado en polietileno. Aumenta la Temperatura del agua hasta 6°C. Mas de 12 kw/h de calor al dia. 600x60 cm. Peso 7 kg. Potencia de la bomba mínima recomendada: 1/3 CV.

Made of polythene. Water temperature can be increased up to 6 °C. 600x60 cm. Wight: 7 kg. Minimum recommended pump output: 1/3 hp.

Il augmente la température de l'eau jusqu'à 6°C. 600x60 cm. Poids 7 kg. Puissance de la pompe minimale recommandée: 1/3 CV.

In polietilene. Aumenta la temperatura dell'acqua fino a 6°C. 600x60 cm. Peso 7 kg. Potenza minima della pompa raccomandata: 1/3 CV.

REF. 90230 CBX PACK 1



Permite aumentar la temperatura de su piscina por la acción del sol. Los calentadores pueden conectarse entre sí en serie. Aumenta la temperatura del agua 3°C en piscinas entre 7,5m² y 10m².

Solar pool water heating system. The heaters should be connected in series to heat the pool. Each solar heater increases the temperature of the swimming pool by 3°C due to solar action.

Système pour le chauffage solaire de l'eau de la piscine. Les réchauffeurs peuvent se connecter entre eux en série. Augmente la température de 3°C max. pour les piscines entre 7,5m² et 10m².

Permette di aumentare la temperatura della sua piscina tramite l'azione dei raggi solari. Ogni riscaldatore solare permette di aumentare la temperatura della piscina no a 3°C tramite l'azione naturale del sole.

DUCHAS MINIMAL MINIMAL SHOWERS
DOUCHES MINIMALES DOCCIA MINIMAL



REF. DAI43

BXL PACK 1



Ducha de acero inoxidable.
 Tubo Ø43 mm.
 Rociador antical.

Stainless steel shower.
 43 mm diameter tube.
 Lime-free overhead sprayer.

Douche en acier inoxydable.
 Tube Ø43 mm.
 Pomme anti-calcaire.

Doccia in acciaio inossidabile.
 Tubo Ø43 mm.
 Doccino anticalcare.

REF. DAI43F

BXL PACK 1



Ducha de acero inoxidable.
 Tubo Ø43 mm.
 Rociador antical.
 *Incluye lavapiés.

Stainless steel shower.
 43 mm diameter tube.
 Lime-free overhead sprayer.
 *Includes foot tap.

Douche en acier inoxydable.
 Tube Ø43 mm.
 Pomme anti-calcaire.
 *Inclut un rince-pieds.

Doccia in acciaio inossidabile.
 Tubo Ø43 mm.
 Doccino anticalcare.
 *Include lavapiedi.

Anclaje y conexión a la toma de agua a través del suelo. Assembly and water connection intake through the ground. Fixation et branchement à l'arrivée d'eau par le sol. Fissaggio e collegamento alla presa d'acqua attraverso il terreno.

DUCHAS SOLARES SOLAR SHOWERS
DOUCHES SOLAIRES DOCCESOLARI



REF. DSALR32W

BXL PACK 1



Ducha solar redonda 32l
 Aluminio aspecto madera
 Con grifo lavapiés

Round solar shower 32l
 Aluminium Woodlike
 With footwash tap

Douche solaire ronde 32l
 Aluminium Aspect bois
 Avec robinet lave pieds

Doccia solare round 32l
 Alluminio Imitazione legno
 Rubinetto lavapiedi



REF. DSALC32W

BXL PACK 1



Ducha solar cuadrada 32l
 Aluminio Aspecto madera
 Con grifo lavapiés

Square solar shower 32l
 Aluminium Woodlike
 With footwash tap

Douche solaire carrée 32l
 Aluminium Aspect bois
 Avec robinet lave pieds

Doccia solare square 32l
 Alluminio Imitazione legno
 Rubinetto lavapiedi

■ complementos ■ complements





Ref. SSP40
BXL PACK 1

8 412081 307091

Ducha solar 40l
PVC-Con grifo lavapies
Solar shower 40l
PVC. With footwash tap
Douche solaire 40l
PVC. Avec robinet lave pieds
Doccia solare 40l
PVC. Rubinetto lavapiedi





Ref. DSPS35
BXL PACK 1

8 412081 272603

Ducha solar 35l
PVC-Con grifo lavapies
Solar shower 35l
PVC. With footwash tap
Douche solaire 35l
PVC. Avec robinet lave pieds
Doccia solare 35l
PVC. Rubinetto lavapiedi



Ref. AR1035P
BXL PACK 1

8 412081 307114

Ducha solar 35l
PVC-Con grifo lavapies
2 piezas
Solar shower 35l
PVC. With footwash tap
2 pieces
Douche solaire 35l
PVC. Avec robinet lave pieds
2 pièces
Doccia solare 35l
PVC. Rubinetto lavapiedi
2 pezzi





REF. AR1130
BXL PACK 1

8 412081 224510

Ducha solar de jardín 32l
Aluminio
Con nebulizador y grifo lavapies
Round solar shower 32l
Aluminium
With footwash tap
Douche solaire 32 litres avec
brumisateur et lave-pieds
Aluminium
Doccia solare 32l
Alluminio
Nebulizzatore e rubinetto lavapiedi



REF. DSA30
BXL PACK 1



Ducha solar 30l
Aluminio
Solar shower 30l
Aluminium
Douche solaire 30l
Aluminium
Doccia solare 30l
Alluminio



REF. AR1030
BXL PACK 1



Ducha solar 30l
PVC
Garden solar shower 30l
PVC
Douche solaire de jardin 30l
PVC
Doccia solare 30l
PVC



Ref. SSR25
BXL PACK 1



Ducha solar 25l
Polietileno-Con grifo lavapies
Solar shower 25l
Polyethylene. With footwash tap
Douche solaire 25l
Polyéthylène. Avec robinet lave pieds
Doccia solare 25l
Polietilene. Rubinetto lavapiedi



REF. AR10250
BXL PACK 1



Ducha solar 25l
PVC
Garden solar shower 25l
PVC
Douche solaire de jardin 25l
PVC
Doccia solare 25l
PVC

■ complementos ■ complements



REF. AR1020W

BXL PACK 1



8 412081 264387

Ducha solar 20l
PVC aspecto madera
Solar shower 20l
Woodlike PVC
Douche solaire 20l
PVC Aspect bois
Doccia solare 20l
PVC Imitazione legno



REF. 40664A

BXL PACK 1



8 427370 406645

Ducha solar 20l
PVC
Garden solar shower 20l
PVC
Douche solaire de
jardin 20l - PVC
Doccia solare 20l
PVC



REF. AR1020P

BXL PACK 1



8 412081 240817

Ducha solar 20l
PVC
2 piezas
Garden solar shower 20l
PVC
2 pieces
Douche solaire de jardin 20l
PVC
2 pièces
Doccia solare 20l
PVC
2 pezzi



Ref. SSAL18

BXL PACK 1



8 412081 307121

Ducha solar 18L
Aluminio - 2 piezas
Solar shower 18l
Aluminium - 2 pieces
Douche solaire 18l
Aluminium - 2 pièces
Doccia solare 18l
Alluminio - 2 pezzi

■ compléments ■ complementi



REF. AR1009
BXL PACK 1



Ducha solar 9l
PVC
2 piezas
Garden solar shower 9l
PVC
2 pièces
Douche solaire de jardin 9l
PVC
2 pièces
Doccia solare 9l
PVC
2 pezzi



REF. AR104
CBX PACK 6



Ducha aluminio. Fácil instalación y conexión
Aluminium shower.
Easy installation and connection
Douche en aluminium.
Montage et raccordement facile
Doccia alluminio.
Facilità di installazione e collegamento



REF. DPE10 BXL PACK 12



Ducha para piscina sobre suelo. Con sistema de fijación al pasamanos de la escalera

Above-ground pool shower. With stair railings fixing system. No tools required

Douche pour piscine hors sol. Système de fixation à mâchoire universelle pour échelle tubulaire ou autres supports

Doccia per piscine fuori terra. Con sistema di fissaggio al corrimano della scaletta



REF. LP01 PB PACK 6



Lavapiés Footwash Pédiluve Lavapiedi

■ complementos ■ complements

RACORDERÍA PVC FITTINGS RACCORDS PVC RACORDERIA IN PVC



REF. 40537 
BX PACK 15 8 427370 405372

Enlace Ø 50 HXH PN16
PVC screw Ø 50 mm PN16
Raccord PVC Ø 50 HXH PN16
Raccordo Ø 50 HXH PN16



REF. 40538 
BX PACK 20 8 427370 405389

Enlace 3P. Ø 50 macho 1" 1/2
PN16
PVC 3 piece union solvent
socket Ø50mm1"1/2
Raccord PVC en 3 parties Ø50
macho 1" 1/2 PN16
Raccordo 3P. Ø 50 maschio
1" 1/2 PN16



REF. 40539 
BX PACK 15 8 427370 405396

Raccordo 3P. Ø 50 macho 2"
PN16
PVC 3 piece union solvent
socket Ø 50mm 2"
Raccord PVC en 3 parties Ø
50 macho 2" PN16
Raccordo 3P. Ø 50 maschio
2" PN16



REF. 40541 
BX PACK 8 8 427370 405419

Válvula antiretorno Ø 50 PN16
Check valve Ø 50 mm
Valve anti-retour Ø 50 PN16
Valvola ritorno Ø 50 PN16



REF. 40543 
BX PACK 6 8 427370 405433

Válvula Ø 50 PN10 PN10
PVC ball valve Ø 50 mm PN10
Valve anti-retour Ø 50 PN10
Valvola Ø 50 PN10 PN10



REF. 40555 
BX PACK 10 8 427370 405556

Racord curva Ø 50 90° PN16
PVC elbow 90° Ø 50 mm PN16
Valve anti-retour 90° Ø 50 PN16
Valvola 90° Ø 50 PN16



REF. 40590 
BX PACK 30 8 427370 405907

Codo Ø 50 90° PN16 - para
encolar
PVC 90° elbow solvent
socket Ø 50 mm
Coude PVC à coller Ø 50
90° PN16
Gomito Ø 50 90° PN16 - da
incollare



REF. 40591 
BX PACK 18 8 427370 405914

Codo Ø 50 45° PN16
PVC 45° elbow solvent socket
Ø 50 mm
Coude PVC Ø 50 45° PN16
Gomito Ø 50 45° PN16



REF. 40592
BX PACK 12 8 4 27370 405921

Te Ø 50 PN16 - para encolar
PVC-Tee 90° solvent socket
Ø 50 mm
Raccord en T à coller Ø 50 PN16
Raccordo a T Ø 50 PN16 - da
incollare



REF. 40593
BX PACK 18 8 4 27370 405938

Racord Ø 50 PN16 - para
encolar
PVC union solvent socket Ø
50 mm
Raccord PVC à coller Ø
50 PN16
Raccordo Ø 50 PN16 - da
incollare



REF. 40646
BX PACK 8 8 4 27370 406461

Válvula Ø50 PN10, manguito
rosca macho
Ball valve Ø50 mm
Vanne Ø50 PN10
embout mal
Valvola Ø50 PN10, tubo
filettato maschio



REF. 40553
BX PACK 12 8 4 27370 405532

Adhesivo para PVC 250 g
Blue Adhesive for flexible PVC
pipes 250 g
Colle PVC 250gr
Adesivo per PVC 250 g



REF. 787104 PB PACK 1



Manguera semirígida
reforzada, transparente,
Ø38mm. 25m
Tuyau semi-rigide reforcé,
Transparent, Ø38mm. 25m

Semi-rigid reinforced hose,
transparent, Ø38mm. 25m
Tubo semirigido inforzato,
trasparente, Ø38mm. 25m



REF. 40557 PB PACK 1



Tubo PVC semirígido Ø 50,
25m
Couronne PVC semi-rigide
Ø 50, 25m

Semi-rigid PVC hose Ø 50
mm, 25m
Tubo PVC semirigido Ø 50,
25m



■ Leyenda ■ Legend ■ Légende ■ Legenda

BX

caja
box
box
scatola

BXL

caja con etiqueta
box and label
carton avec étiquette
scatola con etichetta

CB

cartoncillo
cardboard wrap
bande carton
cartone

PBH

bolsa de plástico con cartoncillo
polybag with header
sac plastique avec bande carton
sacchetto di plastica con cartone

BL

blister
blister
blister
blister

CS

doble burbuja
clamshell
double coque
doppio rivestimento

CBX

caja litografiada
colour box
boîte de couleur
scatola serigrafata

PB

bolsa de plástico
polybag
sac plastique
busta di plastica

DIS

display
display
display
display



manguera
hose
tuyau
tubo



cable
wire
câble
cavo

material de limpieza cleaning material

MATERIAL DE LIMPIEZA	136	CLEANING MATERIAL
Robots	138	Robots
Limpiafondos eléctricos	142	Electric cleaners
Limpiafondos automáticos	144	Automatic cleaners
Limpiafondos de aspiración	147	Vacuum cleaners
Kits limpiafondos	148	Vacuum cleaners kits
Limpiafondos Ventury	149	Ventury vaccum
Gama Graphite	150	Graphite range
Gama Confort	152	Confort range
Limpiafondos manuales	154	Vacuum heads
Recogehojas	154	Leaf nets and rakes
Cepillos	155	Brushes
Termómetros	156	Thermometers
Dosificadores	158	Dispensers
Mangos telescópicos	159	Telescopic handles
Cardboard range	160	Cardboard range
BOX	162	BOX
Gama ECO	164	ECO range
Espojas	166	Sponges
Protección invierno	167	Winter protection
Mangueras flotantes	168	Vacuum hoses

matériel de nettoyage materiale di pulizia

MATÉRIEL DE NETTOYAGE	136	MATERIALE DI PULIZIA
Robots	138	Robots
Nettoyeurs de fond électriques	142	Pulitore elettrico
Nettoyeurs automatiques	144	Puliscifondi automatici
Nettoyeurs par aspiration	147	Pulitore fondo ad aspirazione
Kit nettoyeurs	148	Kit Pulitore fondo
Aspirateurs de fond ventury	149	Puliscifondi Ventury
Gamme Graphite	150	Gamma Graphite
Gamme Confort	152	Gamma Confort
Balais manuels	154	Puliscifondo manuale
Épousettes	154	Raccoglitori
Brosses	155	Spazzole
Thermomètres	156	Termometri
Doseurs	158	Dosatori
Manches télescopiques	159	Manico telescopico
Cardboard range	160	Cardboard range
BOX	162	BOX
ECO range	164	ECO range
Eponges	166	Spugne
Protection hiver	167	Protezione inverno
Tuyaux flottants	168	Tubi galleggianti

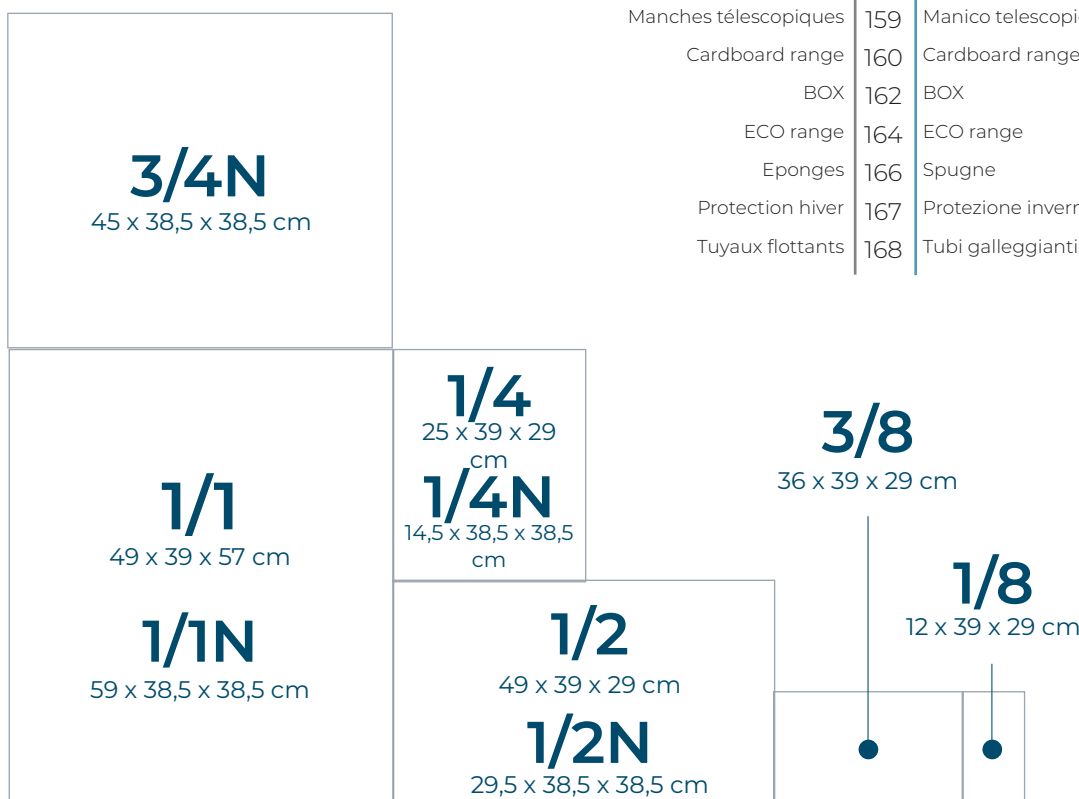

■ material de limpieza ■ cleaning material

ROBOTS LIMPIAFONDOS PISCINAS POOL ROBOTS ROBOTS PISCINE ROBOTS PER PISCINA

KAYAK FUTURE REMOTE CONTROL REF. RKFA100CR

18 m

CBX PACK 1



El Kayak Future CR se adapta a todo tipo de piscinas hasta 120m² de superficie y limpia el fondo, las paredes y la línea de agua de su piscina.

Le robot Kayak Future RC convient pour tout type de piscine d'une superficie jusqu'à 120 m². Il nettoie le fond, les parois ainsi que la ligne d'eau.

The Kayak Future CR adapts to all types of pools measuring up to 120m² in surface area, cleaning the bottom, walls and water line.

Il Robot Kayak Future CR si adatta a tutti i tipi di piscine fino a 120m² di superficie, pulendo il fondo, le pareti e linea dell'acqua.

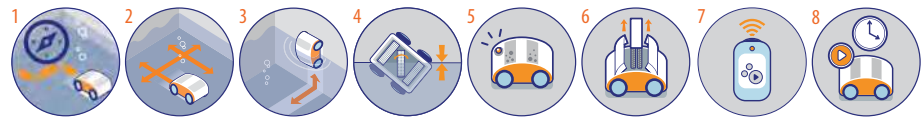

KAYAK FUTURE REF. RKFA100

18 m

CBX PACK 1



El Kayak Future se adapta a todo tipo de piscinas hasta 120m² de superficie y limpia el fondo, las paredes y la línea de agua de su piscina.

Le robot Kayak Future convient pour tout type de piscine d'une superficie jusqu'à 120 m². Il nettoie le fond, les parois ainsi que la ligne d'eau.

The Kayak Future adapts to all types of pools measuring up to 120m² in surface area, cleaning the bottom, walls and water line.

Il Robot Kayak Future si adatta a tutti i tipi di piscine fino a 120m² di superficie, pulendo il fondo, le pareti e linea dell'acqua.

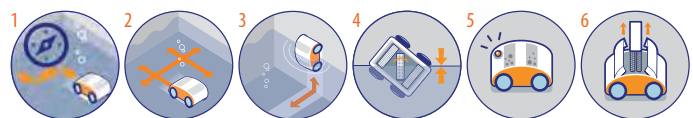

1. GYRO: Nuevo Sistema de Navegación Giroscópica que maximiza el ciclo de lavado y evita que el cable se enrede **New Gyroscopic Navigation System to improve navigation of the robot, maximize efficacy and prevent cable tangling** Nouveau système de navigation qui maximise le cycle de lavage et empêche l'enchevêtrement du câble **Nuovo sistema di navigazione che massimizza il ciclo di lavaggio e previene l'aggrovigliamento dei cavi**
2. Aquasmart System: Algoritmo patentado para limpiar la piscina en menos tiempo **Patented algorithm for covering a pool with less time** La fonction Aquasmart est un algorithme permettant un nettoyage plus rapide et plus efficace **Algoritmo certificato per pulire una piscina in minor tempo**
3. Floor & Walls: Limpia el suelo y las paredes de la piscina **Cleans the bottom and walls** Nettoie le fond et les parois de la piscine **Pulisce fondo e pareti della piscina**
4. Water line: Limpia la línea de flotación **Cleans the water line** Nettoyage de la ligne d'eau **Pulisce la linea dell'acqua**
5. Filter check: Indicador de filtro lleno mediante LED **Full filter LED indicator** Indicateur LED dans le transformateur indiquant que le filtre est plein **Indicatore filtro pieno mediante un LED luminoso**
6. Top access: Filtro de acceso superior **Top access filter** Filtre facile à nettoyer avec le système top access **Accesso al filtro nella parte superiore del robot**
7. Remote Control: Con mando a distancia **With easy remote control** Télécommande de contrôle **Telecomando a distanza**
8. Timer: Ciclo de limpieza programable **Programmable cleaning cycle** Cycle de nettoyage programmable **Ciclo di pulizia programmabile**

■ matériel de nettoyage ■ materiale di pulizia



TRACK 4x4

REF. R44SP

18 m

CBX PACK 1



8 412081 252230

El Track 4x4 se adapta a todo tipo de piscinas hasta 90m² de superficie y limpia el fondo y las paredes de su piscina.

The Track 4x4 adapts to all types of pools measuring up to 90m² in surface area and cleaning the bottom.

Le robot Track 4x4 convient pour tout type de piscine d'une superficie jusqu'à 90 m². Il nettoie le fond ainsi que les parois.

Il Robot Tracks 4x4 si adatta a tutti i tipi di piscine fino a 90m² di superficie, pulendo il fondo e le pareti.



KAYAK ADVENTURE

REF. RKA80

18 m

CBX PACK 1



8 412081 252254

El Kayak Adventure se adapta a todo tipo de piscinas hasta 100m² de superficie y limpia el fondo, las paredes y la línea de agua de su piscina.

The Kayak Adventure adapts to all types of pools measuring up to 100m² in surface area, cleaning the bottom, walls and water line.

Le robot Kayak Adventure convient pour tout type de piscine d'une superficie jusqu'à 100m². Il nettoie le fond, les parois ainsi que la ligne d'eau.

Il Robot Kayak Adventure si adatta a tutti i tipi di piscine fino a 100m² di superficie, pulendo il fondo, le pareti e linea dell'acqua.



1. GYRO: Nuevo Sistema de Navegación Giroscópica que maximiza el ciclo de lavado y evita que el cable se enrede **New Gyroscopic Navigation System to improve navigation of the robot, maximize efficacy and prevent cable tangling** Nouveau système de navigation qui maximise le cycle de lavage et empêche l'enchevêtrement du câble. Nuovo sistema di navigazione che massimizza il ciclo di lavaggio e previene l'aggrovigliamento del cavo
2. Floor & Walls: Limpia el suelo y las paredes de la piscina **Cleans the floor and the wall of the pool** Nettoie le fond et les parois de la piscine Pulisce fondo e pareti della piscina
3. Top access: Filtro de acceso superior **Top access filter** Filtre facile à nettoyer avec le système top access **Acceso al filtro nella parte superiore del robot**
4. Max scrubber: Cepillo rotativo de gran velocidad **Fast moving brush** Brosse rotative de grande vitesse **Spazzola rotante di grande velocità**
5. Easy view: Ventana transparente para ver el filtro **Transparent window for seeing inside the filters** Système easy view pour avoir un aperçu sur le niveau de remplissage du filtre **Finestrella trasparente per controllare meglio la situazione del filtro**
6. 4x4: Tecnología 4x4 patentada con un sólo motor de tracción **4x4 patented technology with only one drive motor** Système de traction 4x4 breveté avec 1 seul moteur pour une longévité accrue **Tecnología 4x4 brevettata con un solo motore di trazione**
7. Plug&Play: Conectar y listo para usar **Put the robot in the water and it's ready to clean** Prêt à fonctionner **Una volta collegato è pronto per lavorare**
8. Easy clean: Filtro fácil y rápido de limpiar **Filter that enables quick and easy cleaning** Facilité d'accès pour nettoyer le robot **Filtro facile e rapido da pulire**
9. Light: Robot ligero **Light robot** Robot léger **Leggero**
10. Filter check: Indicador de filtro lleno mediante LED **Full filter LED indicator** Indicateur LED dans le transformateur indiquant que le filtre est plein **Indicatore filtro pieno mediante un LED luminoso**

■ material de limpieza ■ cleaning material

KAYAK ADVENTURE COMPACT

REF. RKA80C

15 m

CBX PACK 1



El Kayak Adventure Compact se adapta a todo tipo de piscinas hasta 100m² de superficie. Limpia el fondo y las paredes de su piscina.

Le robot Kayak Adeventure Compact convient pour tout type de piscine d'une superficie jusqu'à 100m². Il nettoie le fond et les parois.

The Kayak Adventure Compact adapts to all types of pools measuring up to 100m² in surface area, cleaning the bottom and walls.

Il Robot Kayak Adeventure Compact si adatta a tutti i tipi di piscine fino a 100m² di superficie, pulendo il fondo e le pareti.

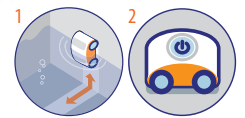

1. Floor & Walls: Limpia el suelo y las paredes de la piscina Cleans the bottom and walls Nettoie le fond et les parois de la piscine Pulisce fondo e pareti della piscina
2. Plug&Play: Conectar y listo para usar Put the robot in the water and it's ready to clean Prêt à fonctionner Una volta collegato è pronto per lavorare

TRACK 1

REF. RTIS

15 m

CBX PACK 1



El Track 1 se adapta a todo tipo de piscinas hasta 60m² de superficie y limpia el suelo y la media caña de piscinas con borde curvo.

Le Track 1 s'adapte à toutes les piscines de jusqu'à 60m² de surface et il permet de nettoyer le fond et les bords arrondis des piscines.

The Track 1 adapts to all types of pools measuring up to 60m² in surface area, cleaning the floor and the half tube with curved edge.

Il Track 1 si adatta a tutte le tipologie di piscine fino a 60m² di superficie e pulisce il fondo e le stonature delle pareti delle piscine a bordo curvo.



1. Easy clean: Filtro fácil y rápido de limpiar Filter that enables quick and easy cleaning Facilité d'accès pour nettoyer le robot Filtro facile e rapido da pulire
2. Easy view: Ventana transparente para ver el filtro Transparent window for seeing inside the filters Système easy view pour avoir un aperçu sur le niveau de remplissage du filtre Finestrella trasparente per controllare meglio la situazione del filtro
3. Plug&Play: Conectar y listo para usar Put the robot in the water and it's ready to clean Prêt à fonctionner Una volta collegato è pronto per lavorare
4. Light: Robot ligero Light robot Robot léger Leggero
5. Top access: Filtro de acceso superior Top access filter Filtre facile à nettoyer avec le système top access Accesso al filtro nella parte superiore del robot
6. Anti-tangle system: Sistema anti-enredo para un funcionamiento óptimo With anti-tangle system allowing optimal performance Système « anti-emmêlement » pour un rendement optimal Sistema "anti-impigliamento" che consente un'ottima resa

■ matériel de nettoyage ■ materiale di pulizia



KAYAK CLEVER REF. RKC100J

12 m

CBX PACK 1



El Kayak Clever limpia el fondo inclinado o plano de piscinas hasta 60m² de superficie.

The Kayak Clever adapts to all types of pools measuring up to 60m² in surface area, cleaning the bottoms whether they are flat or inclined.

Le robot Kayak Clever RKC100J convient pour tout type de piscine à fond plat ou pente douce d'une superficie jusqu'à 60m².

Il Robot Kayak Clever RKC100J si adatta a tutti i tipi di piscine fino a 60m² di superficie, pulendo il fondo in piano che inclinato.



KAYAK JET BLUE REF. RKJ14

12 m

CBX PACK 1



El Kayak Jet Blue limpia el fondo inclinado o plano de piscinas hasta 60m² de superficie.

The Kayak Jet Blue adapts to all types of pools measuring up to 60m² in surface area, cleaning the bottoms whether they are flat or inclined.

Le robot Kayak Jet Blue convient pour tout type de piscine à fond plat ou pente douce d'une superficie jusqu'à 60m².

Il Robot Kayak Jet Blue si adatta a tutti i tipi di piscine fino a 60m² di superficie, pulendo il fondo in piano che inclinato.

1. Plug&Play: Conectar y listo para usar Put the robot in the water and it's ready to clean Prêt à fonctionner Una volta collegato è pronto per lavorare
2. Light: Robot ligero Light robot Robot léger Leggero
3. Top access: Filtro de acceso superior Top access filter Filtre facile à nettoyer avec le système top access Accesso al filtro nella parte superiore del robot

RECAMBIOS BOLSA FILTRANTE SPARE FILTRATION BAGS RECHARGES SAC POUR ROBOTS RICAMBI SACCO FILTRO

3 bolsas recambio desechables para robot
Sac jetable pour robot - carton de 3 pièces

Non-returnable spare filtration bag - 3 units
Busta per robot usa e getta - scatola di 3 unità

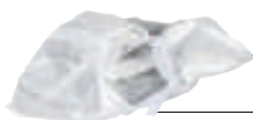

REF. 40684

CBX pack 8



■ material de limpieza ■ cleaning material

LIMPIAFONDOS ELÉCTRICOS ELECTRIC CLEANERS NETTOYEURS DE FOND ÉLECTRIQUES PULITORE ELETTRICO PER FONDO PISCINA

Los limpiafondos eléctricos son una solución cómoda y sencilla para la limpieza de la piscina. Son recargables, sin necesidad de cables y muy manejables debido a su tamaño y forma.

Les nettoyeurs de fond électriques sont une solution pratique et simple pour le nettoyage des piscines. Ils sont rechargeables, sans besoin de câbles et très faciles à utiliser en raison de leur taille et de leur forme.

Electric cleaners are a convenient and simple solution for cleaning the pool. They are rechargeable, wirelessly and very manageable because of its size and shape.

I pulitori elettrici per fondo piscina rappresentano una soluzione comoda e semplice per la pulizia della piscina. Sono ricaricabili, non necessitano di cavi e sono maneggevoli grazie alle loro dimensioni e alla forma.



ELECTRIC VAC PLUS

REF. VCB50

CBX PACK 1



8 412081 272528

Limpiafondos eléctrico autónomo - Potencia: 36 W. Se puede utilizar con su propio mango o conectado a un mango telescópico estándar para facilitar su uso en piscinas más profundas. Recargable, sin cables. Incluye 3 baterías recargables litio (4000mah/11,1V). Potencia de succión: 90 l/h. Tiempo de trabajo: 90 minutos. Ligero, fácil de manejar.

Nettoyeur électrique autonome - Puissance: 36 W. Il peut être utilisé avec sa propre poignée ou attaché à une poignée télescopique standard pour faciliter son utilisation dans des bassins plus profonds. Rechargeable, sans câbles. Comprend 3 batteries rechargeables au lithium (4000mah / 11.1V). Puissance d'aspiration: 90 l/h. Temps de travail: 90 minutes. Léger, facile à manipuler.

Autonomous electric cleaner – Power: 36 W. Can be used with its own handle or connected to a standard telescopic handle for ease use in deeper pools. Rechargeable, without cables. It includes 3 rechargeable lithium batteries (4000mah /11.1V). Suction power: 90 l/h. Working time: 90 minutes. Lightweight, easy to handle.

Pulitore elettrico autonomo - Potenza: 36 W. Si può usare con il manico in dotazione o collegato ad un'asta telescopica per agevolare il suo utilizzo in piscine più profonde. Ricaricabile, senza cavo. Include 3 batterie ricaricabili litio. (4000mah/11,1V). Potenza di assorbimento: 90 l/h. Tempo di lavoro: 90 minuti. Leggero, facile da maneggiare.



ELECTRIC VAC

REF. VCB10

CBX PACK 2



8 412081 263298

Especialmente indicado para piscinas enterradas, limpia las escaleras y esquinas donde el limpiafondos automático no llega. Posee un depósito removible de gran capacidad e incorpora un filtro que retiene partículas de pequeño tamaño. Ligero y de fácil manejo. Recargable y sin cables: funciona con batería de litio recargable de 11,1 V. Posibilidad de uso con su propio asa o conectándolo a una pértiga. Spécialement conçu pour les piscines enterrées. Il nettoie les escaliers et les angles, contrairement au nettoyeur de fond automatique. Il est muni d'un réservoir amovible de grande capacité et il incorpore un filtre qui retient les particules de petite taille. Léger et facile à manipuler. Rechargeable et sans câbles : il fonctionne avec un accumulateur lithium rechargeable de 11,1 V. Il peut être utilisé avec sa poignée ou bien connecté à une perche.

Especially indicated for embedded pools, cleans stairs and corners where automatic cleaners do not reach. It has a large capacity removable tank and includes a filter to retain small-size particles. Lightweight and easy to use. Rechargeable and without cables: operates with an 11.1 V lithium battery. Possibilities of use with its own handle or connected to a pole. Particolarmente indicato per piscine interrate, pulisce le scalette e gli angoli che il pulitore automatico non riesce a raggiungere. È dotato di un capiente serbatoio removibile e di un filtro in grado di trattenere le particelle più piccole. Leggero e maneggevole. Ricaricabile e senza fili: funziona con batteria al litio ricaricabile da 11,1V.

■ matériel de nettoyage ■ materiale di pulizia



POOL & SPA VAC

REF. CSPA

CBX PACK 2



8 412081 265315

Limpiafondos para piscinas y spas con mango. Recargable y sin cables. Posibilidad de uso con su propio mango o conectado a una pértiga. Ligero y manejable.

Nettoyeur de fonds pour piscines et spas avec manche. Rechargeable et sans câbles. Il peut être utilisé avec sa poignée ou bien connecté à une perche. Léger et facile à manipuler.

Pool and spa vac with handle. Rechargeable and without cables. Possibilities of use with its own handle or connected to a pole. Lightweight and easy to use.

Pulitore per fondo piscina e spa con manico. Ricaricabile e senza fili. Può essere utilizzato con il manico in dotazione o collegato a un'asta.



STICK VAC

REF. VCB08

CBX PACK 2



8 412081 272535

Limpiafondos eléctrico para piscinas y Spa. Limpiador eléctrico autónomo. Potencia: 10 W. Sin cables. Necesita 8 baterías AA. Poste de extensión de 1,65 m incluido. Peso ligero, fácil manejo. Sin cables.

Nettoyeur de piscine et de spa électrique. Nettoyeur électrique autonome. Puissance: 10 W. Sans câbles. Nécessite 8 piles AA. Perche extensible de 1,65 m inclus. Poids léger, manipulation facile. Pas de câbles.

Pool and spa electric cleaner. Autonomous electric cleaner. Power: 10 W. Without cables. 8 pieces of AA battery needed. Extension pole of 1,65 m included. Lightweight, easy to handle. Without cables.

Pulitore elettrico per piscine e Spa. Pulitore elettrico autonomo - Potenza: 10 W. Senza cavo. Necessita di 8 batterie AA. Asta estensibile di 1,65 m inclusa. Peso leggero, facile da maneggiare. Senza cavi.



REF. ABS3

CBX PACK 1



8 412081 302751

Limpiafondos de batería para piscinas y spas con mango telescópico. Sin cables. Pértiga extensible de 133 cm incluida. Ligero y manejable.

Nettoyeur de fond à batterie pour piscines et spas avec manche télescopique. Sans câbles. Perche extensible de 133 cm incluse. Léger et maniable.

Battery powered pool and spa cleaner with telescopic handle. No cables. Extendible handle of 133 cm included. Lightweight and easy to handle.

Puliscifondo a batteria per piscine e spa con manico telescopico. Senza fili. Prolunga per manico estensibile da 133 cm inclusa. Leggero e maneggevole.

■ material de limpieza ■ cleaning material

LIMPIAFONDOS AUTOMÁTICOS AUTOMATIC CLEANERS NETTOYEURS AUTOMATIQUES PULISCIFONDI AUTOMATICI

ACROBAT REF. ACD10

9m - Ø 38

CBX PACK 1



8 412081 268477

Limpiafondos automático de membrana. Limpia el fondo y las paredes de cualquier piscina. Funciona con sistemas de filtración de una potencia mínima de 1/2CV.

Nettoyeur automatique avec système unique de membrane.

Nettoie le fond et les parois de la piscine. Il fonctionne avec des systèmes de filtration d'une puissance minimum de 1/2cv.

Automatic pool cleaner with membrane system. The Professional Vac cleans the bottom and walls of your pool. Works with 1/2 hp minimum.

Puliscifondo automatico con sistema a membrana. Il Professional Vac pulisce il fondo e le pareti della piscina. Funziona con sistemi di filtrazione che hanno una potenza minima di 1/2cv.



PROFESSIONAL VAC REF. 19007

9,6m - Ø 38

CBX PACK 1



8 427370 190070

Limpiafondos automático de membrana. Limpia el fondo y las paredes de cualquier piscina. Funciona con sistemas de filtración de una potencia mínima de 0,33CV.

Nettoyeur automatique avec système unique de membrane.

Nettoie le fond et les parois de la piscine. Il fonctionne avec des systèmes de filtration d'une puissance minimum de 0,33cv.

Automatic pool cleaner with membrane system. The Professional Vac cleans the bottom and walls of your pool. Works with 0,33 hp minimum.

Puliscifondo automatico con sistema a membrana. Il Professional Vac pulisce il fondo e le pareti della piscina. Funziona con sistemi di filtrazione che hanno una potenza minima di 0,33cv.



■ matériel de nettoyage ■ materiale di pulizia



Max. 1,80m



SILENCE VAC
REF. 90397

□ 9,6m - Ø 38

CBX PACK 2



Limpiafondos automático más silencioso que los sistemas tradicionales de "martillo". Limpia el fondo y las paredes de su piscina. Funciona con sistemas de filtración de una potencia mínima de ½cv y máxima de 1½cv.

Nettoyeur automatique plus silencieux que les systèmes traditionnels à "marteau". Nettoie le fond et les parois de la piscine. Il fonctionne avec des systèmes de filtration d'une puissance minimum de ½cv et maximale de 1½cv.

Automatic pool cleaner which is quieter than the traditional "hammer" systems. The Silence Vac cleans the bottom and walls of your pool. Works with ½ hp minimum and 1½hp maximum power filtration systems.

Puliscifondo automatico più silenzioso dei sistemi tradizionali a "martello". Il Silence Vac pulisce il fondo e le pareti della piscina. Funziona con sistemi di filtrazione che hanno una potenza minima di ½cv e massima di 1½cv.



CLASSIC VAC
REF. 19001

□ 8m - Ø 38

CBX PACK 1



Limpiafondos automático para piscinas enterradas y elevadas dotadas de un equipo de filtración con una potencia mínima de 3/4 cv.

Nettoyeur automatique pour piscines enterrées et hors-sol équipé d'une filtration avec une pompe d'une puissance minimum de 3/4cv.

Automatic pool cleaner for in ground and above ground pools equipped with filtering equipment with a minimum power pump of 3/4 hp.

Puliscifondo automatico per piscine interrate e fuori terra dotate di un sistema di filtrazione con una potenza minima di 3/4 cv.

■ material de limpieza ■ cleaning material

WIKI VAC

REF. 90399

6m - Ø 32

CBX PACK 2



8 427370 903991

Limpiafondos automático para piscinas autoportantes y elevadas. Funciona con equipos de filtración de baja potencia: a partir de 0,1cv. Dispone de un prefiltro exclusivo que permite proteger el cartucho y la filtración.

Nettoyeur automatique pour piscines autoportantes et hors-sol. Il fonctionne avec des filtrations de très faible puissance: à partir de 0,1cv minimum. Il dispose d'un préfiltre exclusif qui protège la cartouche et la filtration.

The automatic pool cleaner for inflatable or above ground pools. Works with low-power filtering equipment: ranging from 0.1hp. It has a unique pre-filter which protects the cartridge and filtration.

Puliscifondo per piscine autoportanti e fuoriterra. Funziona con un sistema di filtrazione a partire da 0,1 cv di potenza. È dotato di un prefiltro esclusivo che permette una maggior cura della cartuccia e della filtrazione.



SMALL CONFORT

REF. AR20682

6m - Ø 32

CBX PACK 4



8 412081 232287

Limpiafondos automático por aspiración. Se conecta directamente al skimmer y es compatible con bombas a partir de 1/3CV.

Nettoyeur de fond automatique par aspiration. Il se branche directement sur le skimmer et il est compatible avec des pompes à partir de 1/3 de CV.

Automatic suction pool cleaner that is directly connected to the skimmer. Compatible with pumps from 1/3HP.

Puliscifondo automatico ad aspirazione. Si collega direttamente allo skimmer ed è compatibile con pompe a partire da 1/3CV.



REF. PFAC17

CBX PACK 4



8 412081 302744

Prefiltro para limpiafondos de aspiración. Conector de manguera giratorio incluido. Contenedor transparente que permite saber cuándo esta lleno. Capacidad de 1,7 litros.

Préfiltre pour aspirateur. Raccord de tuyau rotatif inclus. Conteneur transparent qui vous permet de savoir quand il est plein. Capacité de 1,7 litres.

Prefilter to be used with suction cleaners. Big capacity prefilter. Swivel hose connector included. Clear container allows to see when basket is full. 1,7 liters capacity.

Prefiltro per Puliscifondo. Connettore per tubo flessibile incluso. Contenitore trasparente che ti consente di sapere quando è pieno. Capacità di 1,7 litri.



LIMPIAFONDOS DE ASPIRACIÓN MANUAL VACUUM CLEANERS
NETTOYEURS ASPIRANTS PULITORI AD ASPIRAZIONE MANUALE



MEDIUM VAC
REF. AR20637

□ 9m - Ø 32

CBX PACK 6



8 412081 231099

Kit de mantenimiento para piscinas autoportantes o elevadas. Contiene dos boquillas (una de ellas con cepillo).

Maintenance kit for inflatable or above ground pools. The pool cleaner includes: two suction nozzles, one with a brush.

Kit d'entretien pour piscines autoportantes ou hors-sol. Contient: un aspirateur de fond à aspiration manuelle qui inclut deux embouts.

Kit di mantenimento per piscine autoportanti o fuori terra. Contiene due aspiratori, uno con pennello



LITTLE VAC
REF. 08011A

□ 5m - Ø 32

CBX PACK 6



8 427370 080111

Kit de mantenimiento para piscinas autoportantes o elevadas.

Maintenance kit for inflatable or above ground pools.

Kit d'entretien pour piscines autoportantes ou hors-sol.

Kit di mantenimento per piscine autoportanti o fuori terra.

■ material de limpieza ■ cleaning material

KITS LIMPIAFONDOS VACUUM CLEANER KITS

KITS NETTOYEURS ASPIRANTS KIT PULITORI FONDO AD ASPIRAZIONE

REF. AR20641

CBX PACK 2



8 412081 224718

Limpiafondos para pértiga + pértiga 3 secciones + recogedor de fondo + termómetro flotante + dosificador oval + cepillo para liner + manguera 6m + bote de tiras reactivas (tester)

Bottom cleaner for pole + 3 section pole + leaf rake + floating thermometer + oval dispenser + brush for liner + 6m hose + can of reactive test strips (tester)

Pack d'entretien comprenant: un nettoyeur de fond + perche 3 sections + epuisette de fond + thermomètre flottant + doseur ovale pour galets de 200gr + brosse pour liner + 6m tuyau + boîte de bandelettes de test (tester)

Puliscifondi + pertica 3 sezioni + raccogliatore di fondo + termometro galleggiante + dosatore ovale + spazzola per liner + 6m tubo + confezione da striscie reattive (tester)



REF. AR2064

CBX PACK 4



8 412081 202433

Kit limpiafondos + pértiga 3,60m (3x1,20m) + manguera 6m

Vacuum head kit + handle 3,60m (3x1,20m) + 6m hose

Kit nettoyeur + manche 3,60m (3x1,20m) + tuyau 6m

Kit puliscifondo + pertica 3,60m (3x1,20m) + tubo 6m



REF. KMA05

CS PACK 6



8 412081 237664

Kit mantenimiento piscinas: analizador pH/Cl, cepillo 45 cm, recogehojas superficie, termómetro y limpiafondos

Pool maintenance kit: pH/Cl Test kit, 45 cm Brush, leaf net, thermometer and Vacuum head

Kit de nettoyage pour piscines: analyse pH/Cl, brosse 45 cm, époussette de surface, thermomètre et balai manuel

Kit di mantenimento per piscine: analizzatore ph/cl, spazzola 45 cm, raccogliatore di superficie, termometro e puliscifondo



REF. KMSPA

CS PACK 6



8 412081 264967

Kit mantenimiento para spa hinchable o rígido. Incluye: Recogehojas · cepillo · Esponja de la línea de flotación · Pértiga

Maintenance kit for Inflatable and rigid spas. Includes: Leaf skimmer · Brush · Water line cleaner sponge · Pole

Kit d'accessoires pour spa gonflable ou rigide. Le kit comprend: Une époussette · Une brosse · Eponge ligne d'eau · Manche

Mantenimento per spa gonfiabili o parete rigida. Include: Raccogliatore · Spazzola · Spugne per la linea di galleggiamento · Pertica



■ matériel de nettoyage ■ materiale di pulizia

LIMPIAFONDOS VENTURY VENTURY VACUUM ASPIRATEURS DE FOND VENTURY PULISCIFONDI VENTURY



REF. 08050

CS PACK 6



Kit piscina autoportante:
analyzer pH/Cl, cepillo,
recogehojas de superficie,
mango 1,20m (3 tramos)
termómetro tubular,
dosificador y jet vac ventury.

Special inflatable pool
kit: pH/chlorine test kit,
brush, leaf net, tubular
thermometer, 1,20m
handle (3 sections), floating
dispenser and ventury
vacuum.

Kit spécial piscine
autoportante: trousse
d'analyse pH/Cl, brosse,
épuisette de surface,
manche 1,20m (3 parties),
thermomètre tubulaire,
doseur pastilles
rétractable and jet vac ventury.

Kit speciale per piscina
autoportante: analizzatore
pH/Cl, spazzola, Raccogliatore
di superficie, manico 1,20m
(3 sezioni) termometro
tubolare, dosatore e
aspiratore jet vac ventury.



REF. 90111

DIS 3/4N PACK 8



Limpiafondos Micro-Ventury.
Nettoyeur Micro-Venturi.

Micro-Ventury Vacuum.
Puliscifondi Micro-Ventury.



REF. Y15

CBX PACK 12



Kit limpiafondos Ventury
+ pértiga.
Kit Aspirateur de fond
Venturi + manche.

Ventury vacuum kit
+ handle.
Aspiratore Ventury+
pértica.



REF. Y12

CS PACK 50



2 filtros para
limpiafondos ventury
2 filtres pour aspirateur
de fond

2 filters for ventury
bottom cleaner
2 filtri per puliscifondo venturi

■ material de limpieza ■ cleaning material

SERIE GRAPHITE GRAPHITE SERIE GAMME GRAPHITE GAMMA GRAPHITE

Recogehojas de superficie Leaf net
Époussette de surface Raccoglitore di superficie

REF. LSP40

CB PACK 6



Recogehojas de fondo Leaf rake
Époussette de fond Raccoglitore di fondo

REF. LRP40

CB PACK 6



Limpiafondos triangular Triangular suction pool cleaner
Balai triangulaire Puliscifondo triangolare

REF. VHTP40

CB PACK 6



Limpiafondos rectangular Vacuum head rectangular
Balai rectangulaire Puliscifondo rettangolare

REF. VHRP40

CB PACK 6



Ø 5x360 cm
Mango telescópico de aluminio Telescopic aluminium handle
Manche télescopique argenté Manico telescopico argentato

REF. TPP360

CB PACK 6



■ matériel de nettoyage ■ materiale di pulizia

Graphite
SERIES



Cepillo 45 cm
Brosse 45 cm

45 cm brushes
Spazzole 45 cm

REF. WBP45

CS PACK 6



Cepillo 25 cm
Brosse 25 cm

25 cm brushes
Spazzole 25 cm

REF. WBP25

CS PACK 6



Dosificador flotante
pastillas 250gr
Doseur pastilles
flottant 250 g

Tablets floating
dispenser 250gr
Dosatore galleggiante
pastiglie da 250 g

REF. FDP250

CB PACK 12



Dosificador flotante
pastillas 20gr
Doseur pastilles
flottant 20 g

Tablets floating
dispenser 20gr
Dosatore galleggiante
pastiglie da 20 g

REF. FDP20

CB PACK 12



Cepillo manual
multifunción
Brosse manuelle
multifonction

Multi-function
manual brush
Spazzola manuale
multifunzione

REF. HBP20

CS PACK 6



Termómetro digital
flotante
Thermomètre digital
flottant

Floating digital
thermometer
Termometro digitale
galleggiante

REF. THP24

CS PACK 9



■ material de limpieza ■ cleaning material

GAMA CONFORT CONFORT RANGE GAMME CONFORT GAMMA CONFORT

Recogehojas de superficie
Gama confort
Époussette de surface
Gamme confort

Confort range
Leaf net
Raccogliatore di superficie
Gamma confort



REF. 40030N

DISPACK 12



8 412081 272962

Recogehojas de fondo
Gama confort
Époussette de fond
Gamme confort

Confort range
leaf rake
Raccogliatore di fondo
Gamma confort



REF. 40032N

DIS PACK 12



8 412081 272955

Recogehojas
superficie aluminio
Époussette de surface
aluminium

Aluminium
Leaf net
Raccogliatore di
superficie alluminio



REF. RHSALN

DIS PACK 12



8 412081 272979

Recogehojas fondo
aluminio
Époussette de fond
aluminium

Aluminium
Leaf rake
Raccogliatore di
fondo alluminio



REF. RHFALN

DIS PACK 12



8 412081 272986

Termómetro UFO
Thermomètre UFO

UFO thermometer
Termometro UFO



REF. TTUFO

DIS PACK 12



8 412081 273068

Colgador metálico para
material de limpieza

Metalic hanger for
cleaning material

Support mural en métal
pour le rangement du
matériel

Portautensili metallico
per attrezzi di pulizia



REF. BHM5

BX PACK 6



8 412081 273075

■ matériel de nettoyage ■ materiale di pulizia



Cepillo 50 cm
Brosse 50 cm

50 cm brushes
Spazzole 50 cm

REF. 40041N

DIS PACK 12



8 412081 273013



Cepillo 30 cm
Brosse 30 cm

30 cm brushes
Spazzole 30 cm

REF. 40041SN

DIS PACK 12



8 412081 273020



Cepillo aluminio
Gran formato 50 cm
Brosse aluminium
Grand Format 50 cm

Big Format 50 cm
Aluminium brush
Spazzola alluminio
Gran Formato 50 cm

REF. 40046N

DIS PACK 12



8 412081 272993



Limpiafondos triangular
rotativo con cepillos
Balai triangulaire
rotatif avec brosses

Triangular swivelling vac
head with brushes
Puliscifondo triangolare
rotante con spazzole

REF. 40016N

DIS PACK 4



8 412081 273044



Limpiafondos ovalado
rotativo con cepillos
Balai oval rotatif avec
brosses

Oval swivelling vac head
with brushes
Puliscifondo ovale rotante
con spazzole

REF. 40017N

DIS PACK 6



8 412081 273037



Limpiafondos manual rotativo
8 ruedas con cepillos laterales
Balai manuel rotatif 8 roues
avec brosses latérales

Swivelling vacuum head 8
wheels with lateral brushes
Puliscifondo manuale con 8
ruote e spazzole laterali

REF. 40018N

DIS PACK 6



8 412081 273051



Cepillo manual
multifunción
Brosse manuelle
multifonction

Multifunctional
manual brush
Spazzola manuale
multifunzione

REF. 40040N

DIS PACK 12



8 412081 273006

■ material de limpieza ■ cleaning material

RECOGEHOJAS LEAF NETS AND RAKES ÉPUISETTES RACCOGLITORI

Recogehojas de fondo
+ mango telescópico
Épuiette de fond
+ manche télescopique

Leaf rake
+ telescopic handle
Raccoglitore di fondo
+ Manico telescopico

REF. 40031F

CB PACK 12



Recogehojas de
superficie + mango
telescópico

Leaf net
+ telescopic handle

Épuiette de surface
+ manche télescopique

Raccoglitore di superficie
+ Manico telescopico

REF. 40031

CB PACK 12



LIMPIAFONDOS MANUALES VACUUM HEADS BALAIS MANUELS PULISCIFONDO MANUALI

Limpiafondos de
aluminio

Aluminium vac
head

Balai en
aluminium

Alluminio
puliscifondo

REF. 40022

BX PACK 6

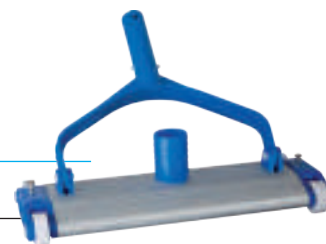

Empuñadura clip
Ø28mm

Clip handle
Ø28mm

Poignée clip
Ø28mm

Impugnatura clip
Ø28mm

REF. 40092

DIS 1/4N pack 6



■ matériel de nettoyage ■ materiale di pulizia

CEPILLOS BRUSHES
BROSSES SPAZZOLE



Cepillo aluminio para
eliminar algas

Brosse aluminium pour
éliminer les algues

Aluminium brush to
eliminate the algae

Spazzola alluminio
per eliminare le alghe



REF. CAA25

DIS 1/4N pack 16



Cepillo aspirante
Brosse aspirante

Vacuum brush
Spazzola con attacco
per aspirare



REF. 40802

DIS 3/4N pack 10



Cepillo aspirador limpia-
esquinas

Brosse aspirante
d'angle

Corners-cleaner
vacuum brush

Spazzola aspiratutto
per angoli



REF. 40806

DIS 1/4N pack 18



■ material de limpieza ■ cleaning material

TERMÓMETROS THERMOMETERS
THERMOMÈTRES TERMOMETRI

Termómetro pez payaso
Thermomètre de poisson clown

Clown fish thermometer
Termometro pesce pagliaccio



REF. TBF20

BXL PACK 12



Termómetro bola
Thermomètre boule

Ball thermometer
Termometro a sfera



REF. 40055

CB pack 15



Termómetro boya
Thermomètre bouée

Buoy thermometer
Termometro galleggiante



REF. 40054

DIS 1/2N pack 10



Termómetro tubular flotante
Thermomètre flottant tubulaire

Tubular floating thermometer
Termometro tubolare



REF. 40051

DIS 1/2N PACK 18



Termómetro "Big"
Doble lectura
"Big" Thermomètre
Double lecture

"Big" thermometer
Double reading
Termometro "Big"
Doppio lettura



REF. 40050

CS pack 12



■ matériel de nettoyage ■ materiale di pulizia

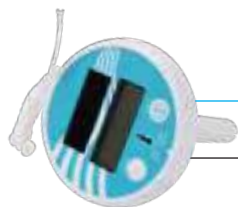

Termómetro digital
flotante
Thermomètre digital
flottant

Floating digital
thermometer
Termometro digitale
galleggiante



REF. 778204

CS PACK 12



Termómetros animal
Thermomètres animaux

Animals thermometer
Termometro animale

REF. 770326

DIS PACK 12



Kit mantenimiento
6 accesorios
Kit entretien
6 accessoires

Maintenance kit
6 accessories
Kit manutenzione
6 accessori

REF. 784880

CS PACK 6



Aspirador cepillo media
luna efecto venturi + bolsa

Jet vac with brush
and bag

Aspirateur brosse demi-lune
effet venturi + sac

Aspiratore con spazzola a
mezzaluna effetto venturi



REF. 772794

CS PACK 6



Bolsa de recambio aspirador
venturi modelo pequeño
Sac de rechange pour
aspirateur venturi petit
modèle

Replacement bag
for jet vac
Sacca di ricambio
per aspiratore venturi
modello piccolo

REF. 770344

PB PACK 24



■ material de limpieza ■ cleaning material

DOSIFICADORES DISPENSERS DOSEURS DOSATORI

Combi Thermo-
dosificador: Dosificador
Capacidad 1,5 Kg
(pastillas de 20 a
500 g) + Termómetro
+ Visor de consumo de
producto

Combi Thermo-doseur:
Doseur Capacité 1,5 Kg
(pastilles de 20 à 500 g) +
Thermomètre + Témoin
de consommation de
produit

Combi Thermo-dosifier:
Dosifier Capacity 1,5 kg (20
500 g tablets) +
Thermometer + Product
Consumption Viewer

Combi Thermo-Dosatore
Capacità 1,5 kg (Tavolette
da 20 a 500 g)
+ Termometro +
Controllo livello del
prodotto

REF. 40070

DIS 1/2N PACK 5



8 427370 400704



Combi Thermo-
dosificador: Dosificador
pastillas de 20 g +
Termómetro + Visor de
consumo de producto

Combi Thermo-doseur:
Doseur pastilles de 20 g +
Thermomètre + Témoin
de consommation de
produit

Combi Thermo-dosifier:
Dosifier 20g tablets +
Thermometer + Product
Consumption Viewer

Combi Thermo-
Dosatore Tavolette da
20 g + Termometro
+ Controllo livello del
prodotto

REF. DCT20

DIS 1/2N PACK 36



8 412081 241463



Dosificador flotante.
Capacidad: 7 pastillas
de 20 g

Doseur flottant.
Capacité 7 pastilles de
20 g

Floating dispenser.
Capacity: 7 tablets
20 g

Dosatore galleggiante.
Capacità 7 pastiglie da
20 g

REF. 40071

DIS 1/2N PACK 30



8 427370 400711



MANGOS TELESCÓPICOS TELESCOPIC HANDLES
MANCHES TÉLESCOPIQUES MANICO TELESCOPICO

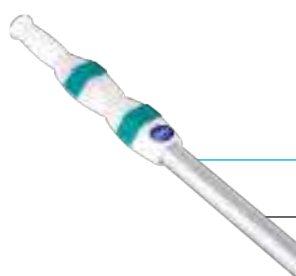

Mango telescópico de aluminio
Manche télescopique argenté
3,60 m (3 x 1,20m)

Telescopic aluminium handle
Manico telescopico argentato

REF. 40014

BX pack 12



8 427370 400148



Mango telescópico de aluminio
Manche télescopique argenté
4,80 m (2 x 2,40m)

Telescopic aluminium handle
Manico telescopico argentato

REF. 40011

BX pack 10



8 427370 400117



Mango telescópico de aluminio
Manche télescopique argenté
3,60 m (2 x 1,80m)

Telescopic aluminium handle
Manico telescopico argentato

REF. 40010

BX pack 10



8 427370 400100



Mango telescópico de aluminio
Manche télescopique argenté
2,40 m (2 x 1,20m)

Telescopic aluminium handle
Manico telescopico argentato

REF. 40013

BX pack 20



8 427370 400131

■ material de limpieza ■ cleaning material

CARDBOARD RANGE

Recogehojas de superficie clásico
Épousette de surface classique

Classic
Leaf net
Raccogliatore di superficie classico

REF. 772804

CB PACK 12



Recogehojas de superficie profesional
Épousette de surface professionnelle

Professional
Leaf net
Raccogliatore di superficie professionale

REF. 772868

CB PACK 12



Recogehojas de superficie + mango aluminio
Épousette de surface + manche aluminium

Leaf net + aluminium telescopic handle
Raccogliatore di superficie + Manico telescopico alluminio

REF. 772869

CB PACK 12



Recogehojas fondo clásico
Épousette de fond classique

Classic
Leaf rake
Raccogliatore di fondo classico

REF. 777580

CB PACK 12



Recogehojas fondo profesional
Épousette de fond professionnelle

Professional
Leaf rake
Raccogliatore di fondo professionale

REF. 772872

CB PACK 12



■ matériel de nettoyage ■ materiale di pulizia



Limpiafondos triangular rotativo con cepillos
Balai triangulaire rotatif avec brosses

Triangular swivelling vac head with brushes
Puliscifondo triangolare rotante con spazzole



REF. 777584

CS PACK 6



3 605217 775849



Limpiafondos ovalado rotativo con cepillos
Balai oval rotatif avec brosses

Oval swivelling vac head with brushes
Puliscifondo ovale rotante con spazzole

REF. 770306

CS PACK 6



3 605217 703064



Limpiafondos rotativo 8 ruedas con cepillos laterales
Balai rotatif 8 roues avec brosses latérales

Swivelling vacuum head 8 wheels with lateral brushes
Puliscifondo con 8 ruote e spazzole laterali



REF. 777573

CS PACK 6



3 605217 775733



Limpiafondos media luna clásico
Tête de Balai demi-lune classique

Half moon vacuum head classic
Puliscifondo mezza luna



REF. 777970

CS PACK 6



3 605217 779700



Cepillo aluminio Gran formato 45 cm
Brosse aluminium Grand Format 45 cm

Big Format 45 cm Aluminium brush
Spazzola alluminio Gran Formato 45 cm



REF. 772877

CB PACK 6



3 605217 728777



Cepillo de pared clásico de 45 cm
Brosse de paroi classique 45 cm

45 cm classic wall brush
Spazzola parete classico 45 cm

REF. 772876

CB PACK 12



3 605217 728760

■ material de limpieza ■ cleaning material

BOX

REF.786500

DIS PACK 1

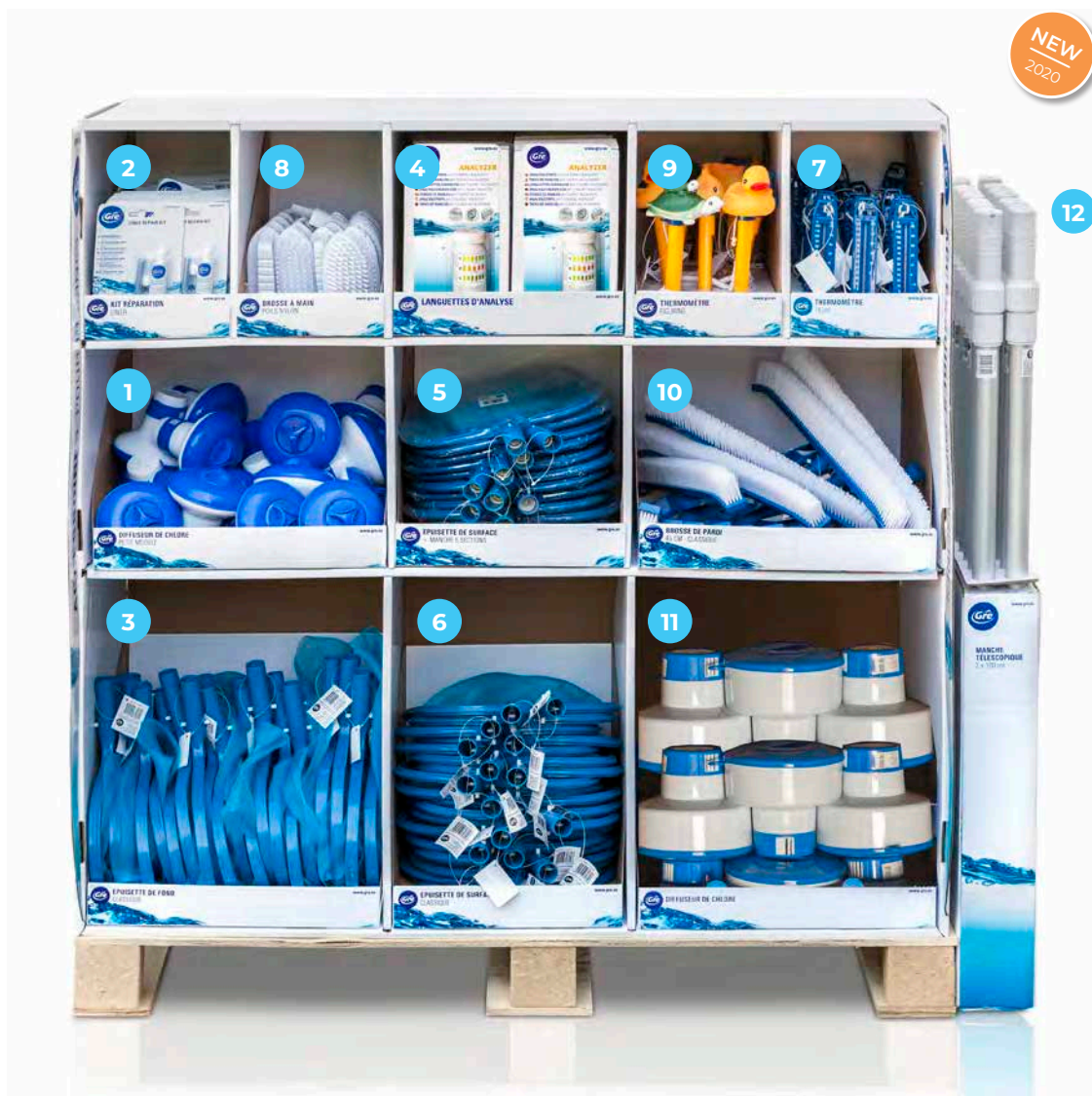

■ matériel de nettoyage ■ materiale di pulizia

REF	N°	Descripción. Describe. Désignation. Descrizione	CTD	EAN 13
778191	1	Dosificador. Dispenser. Diffuseur. Dosatore	24	 3 6 052 17 781918
621201	2	Kit reparación liner. Liner repair kit. Kit réparation liner. Kit riparazione liner	36	 3 6 052 16 212017
777580	3	Recogehojas fondo. Leaf rake. Époussette de fond. Raccogliatore di fondo	20	 3 6 052 17 775801
40068	4	Análisis cloro + pH + alcalinidad. Chlorine + pH + alkalinity analysis. Analyse chlore + pH + alcalinité. Analisi cloro + pH + alcalinità .	40	 8 4 273 70 400681
783810	5	Recogehojas superficie. Leaf net. Époussette surface. Raccogliatore superficie	12	 3 6 052 17 838100
772804	6	Recogehojas superficie PVC. PVC Leaf net. Époussette surface PVC. Raccogliatore superficie PVC	20	 3 6 052 17 728043
778201	7	Termómetro 16 cm. thermometer 16 cm. Thermomètre 16 cm. Termometro 16 cm.	33	 3 6 052 17 782014
770340	8	Cepillo manual. Hand brush. Brosse à main. Spazzola manuale	21	 3 6 052 17 703408
770326	9	Termómetros animal. Animals thermometer. Thermomètre animaux. Termometro animale	12	 3 6 052 17 703262
772876	10	Cepillo de pared 45 cm. 45 cm wall brush. Brosse de paroi 45 cm. Spazzola parete 45 cm	12	 3 6 052 17 728760
778192	11	Dosificador flotante. Tablets floating dispenser. Doseur de galets. Dosatore galleggiante.	12	 3 6 052 17 781925
770342	12	Mango telescópico. Telescopic handle. Manche télescopique. Manico telescopico	16	 3 6 052 17 703422

■ material de limpieza ■ cleaning material

ECO RANGE



Recogehojas de superficie Leaf net
Époussette de surface Raccoglitore di superficie

REF. 90115

DIS 3/4N PACK 24



Recogehojas de superficie + Leaf net + handle
mango 122cm 122cm

Epoussette de surface Raccoglitore di superficie
+ manche 122cm + manico 122cm

REF. 90117

CB PACK 24



Recogehojas fondo Leaf rake
Époussette de fond Raccoglitore di fondo

REF. 90120

DIS 3/4N PACK 16



Recogehojas de superficie + Leaf net + 5 section
mango 5secciones 160 cm pole 160 cm

Epoussette de surface + Raccoglitore di superficie +
perche 5 sections 160cm manico sezionabile 160cm

REF. 90184

CB PACK 12

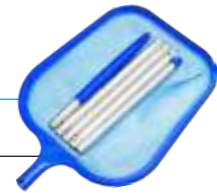

Mango telescópico Telescopic handle
3 x 120 cm 3 x 120 cm

Manche télescopique Manico telescopico
3 x 120 cm 3 x 120 cm

REF. 90100

CB PACK 10

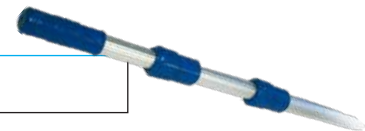

Limpiafondos 1/2 luna Vacuum head
Balai demi-lune Puliscifondo

REF. 90105

DIS 1/2N PACK 12



Aspirador cepillo media Jet vac with brush
luna

Aspirateur brosse Aspiratore con spazzola a
demi-lune mezzaluna

REF. 90110

DIS 3/4N PACK 8



Manguera limpiafondos Vacuum hose 9m
9m Ø38mm Ø38mm

Tuyau pour nettoyeur 9m Tubo puliscifondo 9m
Ø38mm Ø38mm

REF. 90135

BX pack 1



■ matériel de nettoyage ■ materiale di pulizia



Cepillo de 45 cm
Brosse 45 cm

45 cm brush
Spazzola 45 cm

REF. 90127 **DIS 3/4N PACK 24** 8 427370 901270



Cepillo de 20 cm
Brosse 20 cm

20 cm brush
Spazzola 20 cm

REF. 90125 **DIS 1/4N PACK 16** 8 427370 901256



Cepillo línea de agua
Brosse ligne d'eau

Waterline brush
Spazzola per bordo acqua

REF. 90128 **DIS 1/4N PACK 36** 8 427370 901287



Termómetro universal
Thermomètre universel

Universal thermometer
Termometro universale

REF. 90130 **DIS 1/4N PACK 30** 8 427370 901300



Termómetros animal
Thermomètre animaux

Animals thermometer
Termometro animale

REF. 90132 **DIS 1/4N PACK 60** 8 427370 901324



Dosificador flotante.
tabletas 200 gr
Doseur de galets
200 gr

Tablets floating
dispenser 200 gr
Dosatore galleggiante.
pastiglie 200 gr

REF. 90140 **DIS 3/4N PACK 12** 8 427370 901409



Dosificador de pastillas 20 gr
Doseur de pastilles 20 gr

Tablets dispenser 20 gr
Dosatore pastiglie 20 gr

REF. 90141 **DIS 3/4N PACK 40** 8 427370 901416



Analizador de cloro/bromo +
pH (Oto/Phenol)

Test kit chlorine/bromine +
pH (Oto/Phenol)

Trousse chlore/brome
+ pH (Oto/Phénol)

Kit analisi cloro/bromo +
pH (oto/Phenol)

REF. 90180 **DIS 1/4N PACK 32** 8 427370 901805



Recambio Oto/Phenol
Recharge Oto/Phénol

Test kit Oto/Phenol
Ricambio Oto/Phenol

REF. 90181 **DIS 1/4N PACK 60** 8 427370 901812

■ material de limpieza ■ cleaning material

ESPONJAS SPONGES EPONGES SPUGNE



Guante con esponja
para limpiar la línea de
flotación

Glove with
cleaning sponge
for water line

Gant avec éponge pour
le nettoyage de la ligne
de flottaison sur le liner

Guanto in spugna
per pulire la linea di
galleggiamento

REF. GFL5

CB pack 24



8 4 12081 264400



Esponjas mágicas para
la línea de flotación
4 unidades

Water line cleaner
magic sponges
4 units

Eponges magiques
nettoyant la ligne d'eau
4 unités

Spugne magiche per la
linea di galleggiamento
4 unità

REF. PGL4

DIS pack 12



8 4 12081 264431



Esponja de la línea de
flotación

Water line cleaner
sponges

Epongesligne
d'eau

Spugne per la linea di
galleggiamento

REF. 770334

CB PACK 6



3 605217 703347



■ matériel de nettoyage ■ materiale di pulizia

PROTECCIÓN INVIERNO WINTER PROTECTION
PROTECTION HIVER PROTEZIONE PER L'INVERNO



Flotador de hibernaje
Flotteur d'hivernage

Winterising fl oat
Gallegiante inverno

REF. 40580

BX PACK 10



Gizzmo - protección del
skimmer
Gizzmo - protection du
skimmer

Gizzmo - skimmer
protection
Gizzmo - protezione
per skimmer

REF. 40581

BX PACK 12



Tapón de invernaje 1,5"
Bouchon d'hivernage 1,5"

Winterising plug 1,5"
Tappo inverno 1.5"

REF. 40582

BX PACK 6



Tapón de invernaje 2"
Bouchon d'hivernage 2"

Winterising plug 2"
Tappo inverno 2"

REF. 40583

BX PACK 6



■ material de limpieza ■ cleaning material

MANGUERAS VACUUM HOSES TUYAUX FLOTTANTS TUBI GALLEGGIANTI

Manguera limpiafondos 15m
con 2 terminales Ø38mm
Tuyau pour nettoyeur de fond 15m
avec 2 embouts soudés Ø38mm

Vacuum hose 15m
with 2 cuffs Ø38mm
Tubo puliscifondo 15m
con 2 terminali da Ø38mm

REF. 40004

BX pack 1



8 427370 400049



Manguera limpiafondos 12m con
2 terminales Ø38mm
Tuyau pour nettoyeur de fond 12m
avec 2 embouts soudés Ø38mm

Vacuum hose 12m
with 2 cuffs Ø38mm
Tubo puliscifondo 12m
con 2 terminali da Ø38mm

REF. 40003

BX pack 1



8 427370 400032



Manguera limpiafondos 10m con
2 terminales Ø38mm
Tuyau pour nettoyeur de fond 10m
avec 2 embouts soudés Ø38mm

Vacuum hose 10m
with 2 cuffs Ø38mm
Tubo puliscifondo 10m
con 2 terminali da Ø38mm

REF. 40002

BX pack 1



8 427370 400025



Manguera limpiafondos 8m
con 2 terminales Ø38mm
Tuyau pour nettoyeur de fond 8m
avec 2 embouts soudés Ø38mm

Vacuum hose 8m
with 2 cuffs Ø38mm
Tubo puliscifondo 8m
con 2 terminali da Ø38mm

REF. 40001

BX pack 1



8 427370 400018



Manguera limpiafondos 6m con 2
terminales Ø38mm
Tuyau pour nettoyeur de fond 6m
avec 2 embouts soudés Ø38mm

Vacuum hose 6m
with 2 cuffs Ø38mm
Tubo puliscifondo 6m
con 2 terminali da Ø38mm

REF. AR210

BX pack 1



8 412081 960296



■ matériel de nettoyage ■ materiale di pulizia



Manguera limpiafondos 4m
con 2 terminales Ø38mm

Vacuum hose 4m
with 2 cuffs Ø38mm

Tuyau pour nettoyeur de fond
4m avec 2 embouts soudés
Ø38mm

Tubo puliscifondo 4m
con 2 terminali da Ø38mm

REF. AR212

BX pack 1



8 412081 240824



Manguera limpiafondos 12m
con 2 terminales Ø32mm

Vacuum hose 12m
with 2 cuffs Ø32mm

Tuyau pour nettoyeur de fond
12m avec 2 embouts soudés
Ø32mm

Tubo puliscifondo 12m
con 2 terminali da Ø32mm

REF. 770323

BXL pack 1



3 605217 703231



Manguera limpiafondos 7m
con 2 terminales Ø32mm

Vacuum hose 7m
with 2 cuffs Ø32mm

Tuyau pour nettoyeur de fond
7m avec 2 embouts soudés
Ø32mm

Tubo puliscifondo 7m
con 2 terminali da Ø32mm

REF. 770322

BXL pack 1



3 605217 703224



Enrollador de mangueras
flotantes hasta 15m.
(Manguera no incluida)

Vacuum hoses roller
maximum 15m.
(Vacuum hoses not included)

Enrouleur de tuyaux
flottants. Jusqu'à 15m.
(Tuyau non inclus)

Avvolgitore per tubo
galleggiante fino a 15 m. (Tubo
non incluso)

REF. 90165

CBX PACK 1



8 427370 901652



Terminal manguera flotante -
Ø38mm

Hose cuff - Ø38mm

Embout tuyau flottant -
Ø38mm

Raccordo per tubo Ø38 mm

REF. 40012

BX PACK 12



8 427370 400124



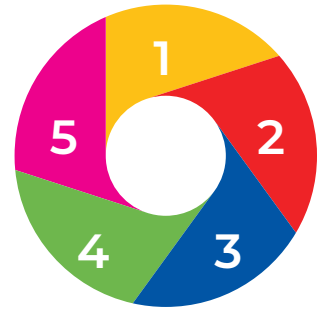

producto químico chemicals
produits d'entretien prodotti chimici



**MADE
IN
EU**

■ producto químico ■ chemicals

PASOS PARA CUIDAR DE SU PISCINA

STEPS TO TAKE CARE OF YOUR SWIMMING POOL

ÉTAPES À SUIVRE POUR PRENDRE SOIN DE VOTRE PISCINE

INDICAZIONI PER IL TRATTAMENTO DELLA PISCINA



Regular el pH
pH regulation
Réguler le pH
Correttori di pH

Higienizar el agua
Water sanitizing
Higiéniser l'eau
Igienizzazione dell'acqua

1

2

3a

3b

3c

¿Cómo?
How?
¿Comment?
¿Come?

Minorador de pH
pH reduce
Baisse le pH
Riduttore di pH

Incrementador de PH
pH increase
Augmente le pH
Incrementatore pH

Cloro choque
Shock chlorine
Chlore choc
Cloro shock

Cloro lento
Slow
chloration
Chlore lent
Cloro lento

Bromo
Bromine
Brome
Bromine

Oxígeno activo
Active oxygen
Oxygène actif
Ossigeno
attivo

¿Para qué?
Why?
¿Pourquoi?
¿Perché?

Obtener un pH entre 7,2 y 7,6
To have a pH value between
7,2 and 7,6
Obtenir un pH entre 7,2
et 7,6
Stabilizzare pH tra 7.2 e 7.6

Higienizar rápidamente y destruir los
organismos, hongos y bacterias
To sanitize quickly and to eliminate all
the organisms and bacteria
Higiéniser rapidement et détruire les
organismes, champignons et bactéries
igienizzare rapidamente e distruggere
tutti gli organismi, funghi e batteri

Desinfectar permanentemente
To have a permanent disinfection
Désinfecter en permanence
Disinfezione permanente

¿Cuándo?
When?
¿Quand?
¿Quando?

A diario
Daily
Chaque jour
Trattamento quotidiano

Al inicio de temporada / Después de
condiciones climáticas extremas / Uso
intensivo de la piscina
At the beginning of the swim season
/ After bad weather conditions / High
use level
Début de saison / Après des conditions
climatiques extrêmes / Usage intensif
de la piscine
Inizio stagione / Dopo che si sono
verificate
cambiamenti climatici molto forti / Uso
intensivo della piscina

A diario
Daily
Chaque jour
Trattamento quotidiano

Resultado
Result
Résultat
Risultato

pH ideal para la piel y
los ojos. Instalaciones en
perfecto estado
Ideal pH for skin and eyes.
Good conditions equipment
pH idéal pour la peau et les
yeux. Installations en parfait
état
pH stabile non genera fastidi
ad occhi e alla pelle

Agua limpia y libre de posibles
contagios
Clean water without contagious risk
Eau propre et libre de possibles
contagions
Acqua pulita e libera da ogni impurità

Agua limpia y libre de posibles contagios
Clean water without contagious risk
Eau propre et libre de possibles contagions
Acqua pulita e libera da ogni impurità

■ produits d'entretien ■ prodotti chimici



Tratamiento antialgas
Anti-algae treatment
Traitement anti-algues
Trattamento antialghe

Floculación
Flocculation
Floculation
Floculante

Complet 4
Actions

Total 5 Actions

Total 10 Actions

4

5

Antialgas concentrado
Concentrated algaecide
Anti-algues concentré
Antialghe concentrato

Antialgas Extra
Extra anti-algae
Anti-algues Extra
Antialghe extra

Floculante
Flocculant
Floculant
Floculante

Fórmula innovadora que permite en una sola aplicación, eliminar bacterias, virus y microorganismos en general
Thanks to its new formula, you can eliminate bacteria, virus and microorganisms
Formule innovatrice, qui permet avec une seule application, d'éliminer bactéries, virus et microorganismes en général
Formula innovativa che permette in una sola applicazione eliminare i batteri, virus e microorganismi in generale

Prevenir la aparición de algas
To avoid algae apparition
Prevenir l'apparition des algues
Prevenire la comparsa delle alghe

Eliminar las algas existentes
To eliminate the algae
Éliminer les algues existantes
Eliminare la presenza di alghe

Eliminar las partículas en suspensión
To eliminate particles in suspension
Éliminer les particules en suspension
Elimina le impurità

4 funciones:
- Cloro
- Antialgas
- Estabilizante
- Floculante

4 functions:
- Chlorine
- Antialgae
- Stabiliser
- Flocculant

4 fonctions:
- Chlore
- Anti-algues
- Stabilisant
- Floculant

4 funzioni:
- Cloro
- Antialghe
- Stabilizzante
- Floculante

5 funciones
- Cloro
- Antialgas
- Estabilizante
- Floculante
Anticalcáreo

5 functions:
- Chlorine
- Antialgae
- Stabiliser
- Flocculant
- Antilime

5 fonctions:
- Chlore
- Anti-algues
- Stabilisant
- Floculant
- Anticalcaire

5 funzioni:
- Cloro
- Antialghe
- Stabilizzante
- Floculante
- Anticalcare

10 funciones:
- Regulador de pH
- Bactericida
- Estabilizante de cloro
- Floculante
- Anticalcáreo
- Virucida
- Algicida
- Fungicida
- Algistático

10 functions:
- Germicide
- pH regulator
- Flocculent
- Chlorine stabilizer
- Coagulant
- Anti-Limescale Agent
- Algicide
- Virucide
- Fungicide

10 fonctions:
- Régulateur de pH
- Bactéricide
- Stabilisant de chlore
- Floculant
- Anticalcaire
- Coagulant
- Virucide
- Algicide
- Fongicide
- Algistatique

Según convenga
Depending on water quality
Selon convenance
Quando necessario

Semanalmente
Weekly
Chaque semaine
Settimanalmente

Agua sin algas
Water without algae
Eau sans algues
Acqua senza alghe

Agua cristalina
Crystalline water
Eau cristalline
Acqua cristallina

10 funzioni:
- Battericida
- Regulatore de pH
- Floculante
- Stabilizzante del cloro
- Coagulante
- Anticalcare
- Alghicida
- Virucida
- Alghistatico
- Funghicida

■ producto químico ■ chemicals

New! • ¡Novedad!
 New single-dose format more comfortable
 Nuevo formato en monodosis más cómodo



MINORADOR DE pH pH REDUCE
BAISSE LE pH RIDUTTORE pH

pH MINUS

MONODOSIS SINGLE-DOSE ECODOSES MONODOSI

Ref. PPHME 650 g DIS 5 412081 303055

Ref. PPHM 650 g DIS 5 412081 302966



INCREMENTADOR DE pH pH INCREASE
AUGMENTE LE pH INCREMENTATORE pH

pH PLUS

MONODOSIS SINGLE-DOSE ECODOSES MONODOSI

Ref. PPHPE 750 g DIS 5 412081 303046

Ref. PPHP 750 g DIS 5 412081 302959



CLORO CHOQUE SHOCK CHLORINE
CHLORE CHOC CLORO SHOCK

CLORCHOC

MONODOSIS SINGLE-DOSE ECODOSES MONODOSI

Ref. PCLSCHE 300 g DIS 5 412081 303062

Ref. PCLSCH 300 g DIS 5 412081 302973



COMPLET 4 ACCIONES COMPLET 4 ACTIONS
COMPLET 4 AZIONI

CHLORE 4 ACTIONS

MONODOSIS SINGLE-DOSE ECODOSES MONODOSI

Ref. PCLMULE 5x250 g DIS 6 412081 303079

Ref. PCLMUL 5x250 g DIS 6 412081 302980

Nouveauté! • Nuovo!

Nouveau format en écodoses très facile à utiliser
Nuovo formato monodosi più confortevole



**ANTIALGAS ANTI ALGAE
ANTI-ALGUES ANTIALGHE**

ANTI - ALGUES

MONODOSIS SINGLE-DOSE ECODOSSES MONODOSI

Ref. **PALGE** 8x20 g DIS 6 412081 303086

Ref. **PALG** 8x20 g DIS 6 412081 302997



**FLOCULANTE FLOCCULANT
FLOCCULANT FLOCCULANTE**

FLOCCULANT

MONODOSIS SINGLE-DOSE ECODOSSES MONODOSI

Ref. **PNATCLE** 4x30 g DIS 8 412081 303083

Ref. **PNATCL** 4x30 g DIS 8 412081 303000



Antialgas + Floculante + Antical + Agua libre de aceites y espuma
Antialgae + Flocculant + Anti lime + Water free of oils and foam
Anti-algues + Flocculant + Anti-calcaire + Eau sans huile ni mousse
Antialghe + Flocculante + Anticalcare + Acqua priva di oli e schiuma

MULTIPROTECT

MONODOSIS SINGLE-DOSE ECODOSSES MONODOSI

Ref. **PCPMPE** 8x35 g DIS 5 412081 303109

Ref. **PCPMP** 8x35 g DIS 5 412081 303017

Filtro de cartucho Cartridge filter Epurateur à cartouche Filtri a cartuccia

Ref. **PCPMPCE** 8x35 g DIS 5 412081 303116

Ref. **PCPMPC** 8x35 g DIS 5 412081 303024



**INVERNADOR WINTERISER
HIVERNAGE TRATTAMENTO PER L'INVERNO**

MONODOSIS SINGLE-DOSE ECODOSSES MONODOSI

Ref. **PWINTCE** 350 g DIS 6 412081 303123

Ref. **PWINTC** 350 g DIS 6 412081 303031



■ producto químico ■ chemicals

PRODUCTO QUÍMICO SIN BÓRICO BORIC FREE CHEMICALS

PRODUIT CHIMIQUE SANS BORIQUE PRODOTTO CHIMICO SENZA BORICO



smartcare
technology

 **BORIC ACID FREE**

 **LONG LASTING**

 **CLEANER**

Producto más sano.

Nuestro aditivo no es en ningún caso perjudicial para la salud.

Healthier product. Our additive is not harmful to health in any way.

Produit plus sain. Notre additif n'est pas nocif pour la santé.

Prodotto più sano. Il nostro additivo non è dannoso per la salute in alcun modo.

Más eficaz. Permite una disolución más lenta y homogénea de la pastilla.

More effective. It allows a slower and more homogeneous dissolution of the tablet.

Plus efficace. Cela permet une dissolution plus lente et plus homogène du comprimé.

Più efficace. Permette una dissoluzione più lenta e omogenea della compressa.

Más limpio. No deja ningún residuo: reduce el consumo de otros químicos y el de agua por limpiezas del filtro.

Cleaner. It does not leave any residue: it reduces the consumption of other chemicals and water.

Plus propre. Il ne laisse aucun résidu: il réduit la consommation d'autres produits chimiques et celle d'eau par le nettoyage du filtre.

Cleaner. Non lascia alcun residuo: riduce il consumo di altri prodotti chimici e quello dell'acqua mediante pulizia del filtro.

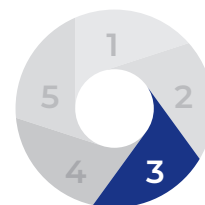

CLORO LENTO TRICHLORINE CHLORE LENT CLORO LENTO

Para conseguir una higienización preventiva y continua del agua, es necesario mantener una tasa de cloración libre. Por ello, conviene efectuar una cloración permanente o "cloración lenta".

To have a preventive and continue sanitizing, it is necessary to keep a free chloration value. For this reason, people must do a permanent chloration or a "slow chloration".

Pour avoir une hygiénisation préventive et continue, il est nécessaire de maintenir un taux de chloration libre. Pour cette raison, il faut effectuer une chloration permanente ou «chloration lente».

Per ottenere una igienizzazione preventiva e continua dell'acqua, è necessario mantenere un valore di cloro "libero". Per questo è bene effettuare una clorazione continua o una "clorazione lenta".

CLORLENT

TABLETAS 250g 250g TABLETS GALETS 250g PASTIGLIE 250g

	Ref. 76087	1,5 Kg	pack 20	
---	-------------------	--------	---------	---

	Ref. 76086	4 Kg	pack 4	
---	-------------------	------	--------	---



COMPLET 4 ACCIONES COMPLET 4 ACTIONS COMPLET 4 AZIONI

Cloro + Antialgas + Estabilizante + Floculante
Chlorine + Antialgae + Stabiliser + Flocculant
Chlore + Anti-algues + Stabilisant + Flocculant
Cloro + Antialghe + Stabilizzante + Flocculante

COMPLET 4 ACTIONS

TABLETAS 250g 250g TABLETS GALETS 250g PASTIGLIE 250g

	Ref. 76090	1,5 Kg	pack 18	
---	-------------------	--------	---------	---

	Ref. 76088	4 Kg	pack 4	
---	-------------------	------	--------	---

	Ref. 76089	4 Kg	pack 60	
---	-------------------	------	---------	---

TOTAL 5 ACCIONES TOTAL 5 ACTIONS TOTAL 5 AZIONI

Cloro + Antialgas + Estabilizante + Floculante + Antical
Chlorine + Antialgae + Stabiliser + Flocculant + Anti lime
Chlore + Anti-algues + Stabilisant + Flocculant + Anti-calcaire
Cloro + Antialghe + Stabilizzante + Flocculante + Anticalcare

TOTAL 5 ACTIONS

TABLETAS 250g 250g TABLETS GALETS 250g PASTIGLIE 250g

	Ref. 76092	1,5 Kg	pack 18	
---	-------------------	--------	---------	---

	Ref. 76091	4 Kg	pack 4	
---	-------------------	------	--------	---

■ producto químico ■ chemicals

Cálculo de volumen de agua

Para un correcto suministro del producto químico, es importante calcular el volumen de agua de la piscina.

Calculate the pool water volume

It is important to calculate the pool water volume to do a correct chemical treatment.

Calcul de volume d'eau

Pour un bon dosage du produit chimique, il est nécessaire de calculer le volume d'eau de la piscine.

Calcolo del volume d'acqua

Per un corretto dosaggio del prodotto chimico è importante calcolare il volume d'acqua di una piscina.

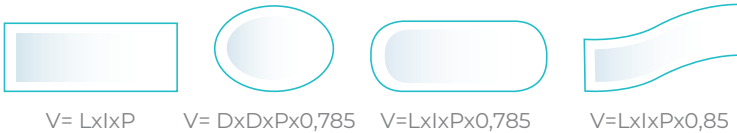

V	Volumen en m ³	Volume in m ³	Volume en m ³	Volume in m ³
L	Longitud en m	Length in m	Longueur en m	Lunghezza in m
I	Anchura en m	Width in m	Largeur en m	Larghezza in m
D	Diámetro en m	Diameter in m	Diamètre en m	Diametro in m
P	Profundidad en m	Depth in m	Profondeur en m	Profondità media in m

Ejemplo Example Exemple Esempio

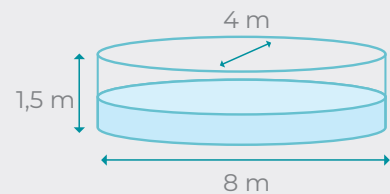

$$1,5 \text{ m} \times 8 \times 4 \times 0,785 = \mathbf{37,68 \text{ m}^3}$$

LEYENDA LEGEND LÉGENDE LEGENDA

	500 g				1 L
	1 Kg		10 Kg		
	1 Kg /1,5 Kg		1 L		1 kg
	3 kg		3 L		1 L / 0,5 L
	5 Kg		5 L		1/2 BOX PALET
	5 Kg		10/20 L		

REGULADORES DE PH PH REGULATORS
RÉGULATEURS DE PH CORRETTORI DI PH

El pH indica la acidez o la basicidad del agua. En una piscina debe mantenerse ajustado entre los valores 7.2 y 7.6, ya que además de conservar las instalaciones en óptimas condiciones, es el ideal para la piel y los ojos de los bañistas.
 pH shows if water is acid or basic. Pool water pH must be between 7.2 and 7.6, because it helps to conserve the equipment in good conditions and it is ideal for swimmer eyes and skin.
 Le pH indique l'acidité ou la basicité de l'eau. L'eau de la piscine doit se maintenir entre les taux 7.2 et 7.6, car il aide à mieux conserver les installations et est l'idéal pour la peau et les yeux des baigneurs.
 Il pH indica la acidità e la basicità dell'acqua. In una piscina il valore di riferimento deve essere sempre tra 7.2 e 7.6, dal momento che, oltre a favorire il trattamento chimico che viene effettuato, è il valore ideale affinché la pelle e gli occhi dei bagnanti non si irritino.

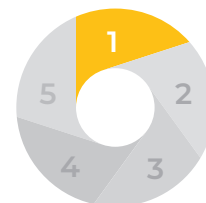

INCREMENTADOR DE pH pH INCREASE
AUGMENTE LE pH INCREMENTATORE pH

pH PLUS
 GRANULADO GRANULES GRANULÉS GRANULATO

 Ref. **76018** 1 Kg pack 20 

 Ref. **76001** 5 Kg pack 4 

Incrementador de pH: para aumentar y estabilizar el pH
 pH increase: to increase and stabilize pH
 Augmente le pH: pour augmenter et stabiliser le pH
 Per aumentare e stabilizzare il pH

MINORADOR DE pH pH REDUCE
BAISSE LE pH RIDUTTORE pH

pH MINUS
 GRANULADO GRANULES GRANULÉS GRANULATO

 Ref. **76019** 1,5 Kg pack 20 

 Ref. **76002** 5 Kg pack 4 

 Ref. **76083** 20 l pack 1 

Minorador de pH: para bajar y estabilizar el pH
 pH reduce: to lower and stabilize pH
 Baisse le pH: pour baisser et stabiliser le pH
 Per abbassare e stabilizzare il pH



■ producto químico ■ chemicals



CLORO CHOQUE SHOCK CHLORINE CHLORE CHOC CLORO SHOCK

El Cloro Choque permite destruir rápida y eficazmente todos los organismos, hongos y bacterias. Conviene realizar una cloración de choque: Al inicio de la temporada de baño / Después de condiciones climáticas extremas / En caso de uso intensivo de la piscina.

It eliminates quickly all the organisms and bacteria. It is necessary to do a Shock chlorination: At the beginning of the swim season / After bad weather conditions / High use level.

Le Chlore Choc permet de détruire rapidement tous les organismes, champignons et bactéries. Il convient d'effectuer une chloration choc: Au début de la saison de baignade / Après des conditions climatiques extrêmes / En cas d'usage intensif de la piscine. Permette di eliminare rapidamente ed efficacemente tutti gli organismi, funghi e batteri. E' utile usare questo tipo di prodotto: All'inizio della stagione / Dopo condizioni climatiche estreme / In caso di un uso intensivo della piscina.

PASTILLAS 20g 20g TABLETS PASTILLES 20g PASTIGLIE 20g



Ref. **76074** 1 Kg pack 20 8 427370 760747



Ref. **76075** 3 Kg pack 4 8 427370 760754



Ref. **76076** 5 Kg pack 4 8 427370 760761

Con un 50% de cloro activo mínimo (triclora).
Disolución instantánea.
Minimum 50% active chlorine (trichlorine). Instant
disolution.

50% chlore actif minimum (trichlore). Dissolution
instantanée.

Con un mínimo del 50% di cloro attivo (triclora).
Dissoluzione istantanea.

CLORCHOC

GRANULADO GRANULES GRANULÉS GRANULATO



Ref. **76021** 1 Kg pack 20 8 427370 760211



Ref. **76062** 1 Kg pack 200 8 427370 760624



Ref. **76069** 3 Kg pack 4 8 427370 760693

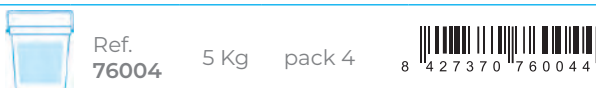

Ref. **76004** 5 Kg pack 4 8 427370 760044

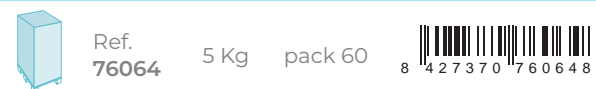

Ref. **76064** 5 Kg pack 60 8 427370 760648

Con un 55% de cloro activo mínimo. Disolución
rápida.

Minimum 55% active chlorine. Quick disolution.

55% chlore actif minimum. Dissolution rapide.

Con un 55% di cloro minimo attivo. Dissoluzione
rapida.



CLORO LENTO TRICHLORINE CHLORE LENT CLORO LENTO

Para conseguir una higienización preventiva y continua del agua, es necesario mantener una tasa de cloración libre. Por ello, conviene efectuar una cloración permanente o "cloración lenta".

To have a preventive and continue sanitizing, it is necessary to keep a free chloration value. For this reason, people must do a permanent chloration or a "slow chloration".

Pour avoir une hygiénisation préventive et continue, il est nécessaire de maintenir un taux de chloration libre. Pour cette raison, il faut effectuer une chloration permanente ou «chloration lente».

Per ottenere una igienizzazione preventiva e continua dell'acqua, è necessario mantenere un valore di cloro "libero". Per questo è bene effettuare una clorazione continua o una "clorazione lenta".

CLORLENT

TABLETAS 250g 250g TABLETS GALETS 250g PASTIGLIE 250g



Ref. **76022** 1 Kg pack 18 8 427370 760228



Ref. **76005** 5 Kg pack 4 8 427370 760051

GRANULADO GRANULES GRANULÉS GRANULATO



Ref. **76023** 1 Kg pack 20 8 427370 760235

■ produits d'entretien ■ prodotti chimici

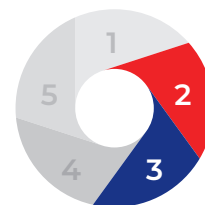

BROMO BROMINE BROME BROMO

Diferencias respecto al cloro: menos olor, no daña la piel ni el cabello. Más eficacia en las aguas calientes y/o calcáreas.

Differences compared to chlorine: less smell, does not dry out skin and hair. More efficient in hot and/or calcareous water.

Différences par rapport au chlore: moins d'odeur, ne dessèche pas la peau ni les cheveux. Plus efficace dans les eaux chaudes et/ou calcaires.

Differenze rispetto al cloro: meno odore, non danneggia la pelle né i capelli. Più effi cace con l'acqua molto calda e/o calcarea.

BROM'LENT

PASTILLAS 20g 20g TABLETS PASTILLES 20g PASTIGLIE 20g



BROM CHOC

GRANULADO GRANULES GRANULÉS GRANULATO



BROM MULTIACCIONES

PASTILLAS 20g 20g TABLETS PASTILLES 20g PASTIGLIE 20g



Bromo multi-Acciones
Bromine multi-Actions
Brome multi-Actions
Bromo multi funzioni



OXÍGENO ACTIVO ACTIVE OXYGEN OXYGÈNE ACTIF OSSIGENO ATTIVO

Ofrece muchas ventajas, ya que proporciona una desinfección muy eficaz y a diferencia del cloro, no provoca irritaciones oculares ni desprende olores desagradables. Producto que necesita de un dosificador.

This product offers a lot of advantages. It disinfects pool water and contrary to chlorine, it does not cause eye irritation neither and bad smells. This product needs a dispenser.

Ce produit offre beaucoup d'avantages par rapport au chlore, car il ne provoque aucune irritation oculaire, ôte les mauvaises odeurs et en même temps fait une désinfection très efficace. Il a besoin d'un doseur. Offre molti vantaggi, dal momento che sviluppa una igienizzazione molto efficace e, a differenza del cloro, non irrita gli occhi e non ha un odore sgradevole. E' un prodotto che necessita del dosatore.

ACTI OXY

LÍQUIDO LIQUID LIQUIDE LIQUIDO

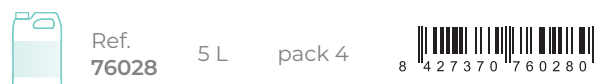

■ producto químico ■ chemicals

Multifunciones Multiactions Multi-actions Multi funzioni

Se trata de un producto revolucionario, ya que gracias a su fórmula innovadora permite en una sola aplicación, eliminar las bacterias, virus y microorganismos en general, evitar el desarrollo de algas, al mismo tiempo que mantiene transparente y cristalina el agua.
Revolution product: Thanks to its new formula, allows in a single application eliminate bacteria, virus and micro organisms, avoid algae and have clear and crystalline water.

Il s'agit d'un produit révolutionnaire. Grâce à sa formule innovatrice, il permet avec une seule application, d'éliminer les bactéries, virus et micro organismes en général, d'éviter l'apparition d'algues, ainsi que de conserver l'eau transparente et cristalline.

Si tratta di un prodotto rivoluzionario proprio perché, grazie alla sua formula innovatrice, permette, in una sola applicazione, di eliminare i batteri, virus e tutti i microrganismi evitando il proliferare di alghe, mantenendo allo stesso tempo l'acqua trasparente e cristallina.

COMPLET 4 ACCIONES COMPLET 4 ACTIONS COMPLET 4 AZIONI

Cloro + Antialgas + Estabilizante + Floculante
Chlorine + Antialgae + Stabiliser + Flocculant
Chlore + Anti-algues + Stabilisant + Flocculant
Cloro + Antialghe + Stabilizzante + Floculante

COMPLET 4 ACTIONS



TABLETAS 250g 250g TABLETS GALETS 250g PASTIGLIE 250g

 Ref. 76007 1 Kg pack 18 

 Ref. 76063 1 Kg pack 200 

 Ref. 76067 3 Kg pack 4 



 Ref. 76006 5 Kg pack 4 

 Ref. 76055 5 Kg pack 60 

 Ref. 76031 10 Kg pack 2 

PASTILLAS 20g 20g TABLETS PASTILLES 20g PASTIGLIE 20g

 Ref. 76032 1 Kg pack 20 

 Ref. 76033 5 Kg pack 4 

GRANULADO GRANULES GRANULÉS GRANULATO

 Ref. 76034 5 Kg pack 4 

50 BLOQUES BLOCKS BLOCS PASTIGLI 500g



 Ref. 76084 25 Kg pack 50 



COMPLET 4 ACTIONS- SPECIAL LINER

TABLETAS 250g 250g TABLETS GALETS 250g PASTIGLIE 250g

 Ref. 76039 1 Kg pack 18 

 Ref. 76012 5 Kg pack 4 

Sin sulfato de cobre
Without copper sulphate.
Sans sulfate de cuivre
Senza solfato di rame



**BOYA MULTIFUNCIÓN
MULTIACTION FLOAT
BOUÉE MULTI-ACTION
TRATTAMENTO GALLEGGIANTE MULTI
FUNZIONE**

HIVER FLOAT

PASTILLAS TABLETS PASTILLES PASTIGLIE



Ref. 76085 1,75 Kg pack 8 



**TOTAL 5 ACCIONES TOTAL 5 ACTIONS
TOTAL 5 ACTIONS TOTAL 5 AZIONI**

Cloro + Antialgas + Estabilizante + Floculante + Antical
Chlorine + Antialgae + Stabiliser + Flocculant + Anti lime
Chlore + Anti-algues + Stabilisant + Flocculant + Anti-calcaire
Cloro + Antialghe + Stabilizzante + Flocculante + Anticalcare

TOTAL 5 ACTIONS

TABLETAS 250g 250g TABLETS GALETS 250g PASTIGLIE 250g



Ref. 76082 1 Kg pack 18 



Ref. 76068 3 Kg pack 4 



Ref. 76036 5 Kg pack 4 



Ref. 76037 10 Kg pack 2 



**MULTIFUNCIÓN MONODOSES
MONODOSE MULTI-ACTIONS
MULTI-ACTIONS MONODOSE
MULTI FUNZIONI MONODOSI**



Cloro + Antialgas + Estabilizante + Floculante
Chlorine + Antialgae + Stabiliser + Flocculant
Chlore + Anti-algues + Stabilisant + Flocculant
Cloro + Antialghe + Stabilizzante + Flocculante

MULTIACTIONS

TABLETAS 250g 250g TABLETS GALETS 250g PASTIGLIE 250g



Ref. 76058 4 Kg pack 16 

16 dosis de 250g. Fácil de usar, dosis exacta. Para piscinas hasta 60m³
250gr 16 dose. Easy to use, accurate dose. Pools up to 60m³.
16 doses de 250g. Facile à utiliser, dose précise. Pour piscines jusqu'à 60m³.
16 dosi da 250 grammi. Semplice da utilizzare: eroga sempre la dose corretta. Per piscine fino a 60 m³

**TOTAL 10 ACCIONES TOTAL 10 ACTIONS
TOTAL 10 ACTIONS TOTAL 10 AZIONI**

Desinfectante + Bactericida + Floculante + Coagulante + Algicida + Algistático + Regulador de pH + Estabilizante de cloro + Anticalcáreo + Virucida + Fungicida
Disinfectant+ Germicide + Flocculent + Coagulant + Algicide + Algistatic + pH regulator + Chlorine stabilizer + Anti-Limescale Agent + Virucide+ Fungicide
Désinfectant + Bactéricide + Flocculant + Coagulant + Algicide + Algistatique + Régulateur de pH + Stabilisant de chlore + Anticalcaire + Virucide + Fongicide
Disinfectante + Battericida + Flocculante + Coagulante + Alghicida + Alghistatico + Regolatore del pH + Stabilizzante del cloro + Anticalcare + Virucida + Funghicida

TOTAL 10 ACTIONS

TABLETAS 250g 250g TABLETS GALETS 250g PASTIGLIE 250g



Ref. 76065 1 Kg pack 18 



Ref. 76038 5 Kg pack 4 

■ producto químico ■ chemicals

Tratamiento antialgas Anti-algae treatment Traitement anti-algues Trattamento antialghe





ANTI-ALGUES EXTRA EXTRA ANTI ALGAE ANTI-ALGUES EXTRA ANTI-ALGHE EXTRA

ANTIALG XTRA

LÍQUIDO LIQUID LIQUIDE LIQUIDO

 Ref. 76041 1 L pack 12 

 Ref. 76072 3 L pack 6 



 Ref. 76042 5 L pack 4 



3 acciones. Extra: para eliminar todas las algas.
3 actions. Extra: to eliminate the algae.
3 actions. Extra: pour éliminer la totalité des algues.
3 azioni. Extra. Per eliminare tutti i tipi di alghe.



ANTIALG

LÍQUIDO LIQUID LIQUIDE LIQUIDO

 Ref. 76009 1 L pack 12 

 Ref. 76071 3 L pack 6 

 Ref. 76008 5 L pack 4 

 Ref. 76056 5 L pack 48 

Para prevenir la aparición de algas.
To prevent the appearance of algae
Pour prévenir l'apparition d'algues.
Per prevenire la comparsa delle alghe.

Las algas son organismos vegetales unicelulares que pueden desarrollarse y multiplicarse rápidamente en el agua, sobre todo cuando su temperatura es templada. Algae are vegetal unicellular organisms that can quickly develop and multiply themselves in the water, specially when the temperature of the water is warm.

Les algues sont des organismes végétaux unicellulaires qui peuvent apparaître et se multiplier très rapidement dans l'eau, surtout quand la température de l'eau est tempérée.



Le alghe sono organismi vegetali unicellulari che possono svilupparsi e moltiplicarsi soprattutto quando la temperatura dell'acqua è abbastanza calda.





ANTI-ALGUES CONCENTRADO CONCENTRATED ANTI ALGAE ANTI-ALGUES CONCENTRÉ ANTI-ALGHE CONCENTRATO

ANTIALG COMPACT XTRA



LÍQUIDO LIQUID LIQUIDE LIQUIDO



 Ref. 76013 1 L pack 12 

 Ref. 76014 0,5 L pack 24 

ANTIALG COMPACT

LÍQUIDO LIQUID LIQUIDE LIQUIDO

 Ref. 76015 1 L pack 12 

 Ref. 76016 0,5 L pack 24 

Floculante Flocculant Floculant Flocculante

La floculación permite obtener un agua cristalina. Existen dos tipos de floculación: la que se realiza dentro del filtro y la floculación dentro del vaso. La primera permite aumentar la fineza de filtración y eliminar de esta manera las partículas más finas. Ésta se efectúa gracias a los cartuchos floculantes (incompatibles con filtros de cartucho) colocados en el cesto del skimmer. La segunda permite agrupar entre ellas las impurezas que no pueden ser filtradas individualmente y que son el origen de un agua turbia. Esta operación se efectúa con el floculante líquido.

Flocculation allows to obtain a crystalline water. There are two kind of flocculation: inside the filter and in the pool. With the first one we increase the fineness of filtration in order to eliminate smaller particles. For this process we introduce flocculants cartridges (incompatible with cartridge filters) in the skimmer basket. The second one helps us to group all the impurities that are the beginning of brown water thanks to liquid flocculant.

La floculation permet d'obtenir une eau cristalline. Il y a deux types de floculation: celle qui se fait dans le filtre et la floculation dans le bassin. La première permet d'augmenter la finesse de filtration et d'éliminer de cette façon les particules plus fine. S'effectue grâce aux cartouches floculantes (incompatibles avec les filtres à cartouche) dans le panier du skimmer. La deuxième permet de regrouper entre elles les impuretés qui ne peuvent pas être filtrées et qui sont l'origine des eaux troubles. Cette opération se fait avec le floculant liquide.

La flocculazione permette di ottenere un'acqua cristallina. Esistono due tipi di flocculazione: quella che si realizza all'interno del filtro e quella diluendo il prodotto in un contenitore. La prima permette di migliorare la filtrazione ed eliminare le particelle più fini e si effettua grazie alle cartucce flocculanti (incompatibili con i filtri a cartuccia) poste dentro il cesto dello skimmer. La seconda permette di raggruppare tra loro le impurità che non possono essere filtrate individualmente e che sono la causa dell'acqua torbida. Questo procedimento si effettua con il flocculante liquido.



CARTUCHOS CARTRIDGES CARTOUCHES CARTUCCIA 125g

Ref. 76044 1 Kg pack 14 8 427370 760440

Para mejorar la calidad de filtración (filtros de arena únicamente). Producto de mantenimiento.
To increase filtration quality (sand filters only).
Product Maintenance.
Pour améliorer la qualité de filtration (filtres à sable uniquement).
Produit de maintenance.
Per migliorare la qualità della filtrazione (solo per filtri a sabbia).
Prodotto di mantenimento.

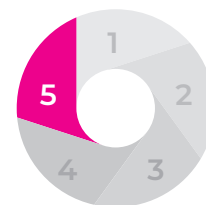

FLOCULANTE LÍQUIDO LIQUID FLOCCULANT FLOCULANT LIQUIDE FLOCCULANTE LIQUIDO

FLOCULANT

LÍQUIDO LIQUID LIQUIDE LIQUIDO

Ref. 76011 1 L pack 12 8 427370 760112

Ref. 76073 3 L pack 6 8 427370 760730

Ref. 76010 5 L pack 4 8 427370 760105

Para clarificar el agua y eliminar las materias en suspensión.
Recupera el agua turbia.
To clarify water and eliminate substances in suspension.
Retrieve the cloudy water.
Pour clarifier l'eau et éliminer les matières en suspension.
Récupère l'eau trouble.
Rende acqua cristallina ed elimina le particelle in superficie.
Recupera l'acqua torbida.

■ producto químico ■ chemicals

PRODUCTOS COMPLEMENTARIOS COMPLEMENTARY PRODUCTS PRODUITS COMPLÉMENTAIRES PRODOTTI COMPLEMENTARI



DESINCRUSTANTE DE SUPERFICIE SURFACE DESCALER DÉTARTRANT DE SURFACE PULITORE SUPERFICI D'ACQUA

DETRATANT SURFACE

LÍQUIDO LIQUID LIQUIDE LIQUIDO



Ref.
76046

1 L pack 12



Para eliminar incrustaciones de cal.
To eliminate lime scales.
Pour éliminer les incrustations calcaires.
Per evitare la incrostazione del calcare.

LIMPIADOR DE BORDES WATERLINE CLEANER NETTOYANT LIGNE D'EAU PULITORE SUPERFICI D'ACQUA

NETTOYANT LIGNE D'EAU

LÍQUIDO LIQUID LIQUIDE LIQUIDO



Ref.
76047

1 L pack 12



Para eliminar la suciedad de la línea de flotación.
To eliminate the dirt on the waterline.
Pour éliminer la saleté sur la ligne d'eau.
Per eliminare particelle in superficie.

TAC PLUS

GRANULADO GRANULES GRANULÉS GRANULATO



Ref.
76081

5 Kg pack 4



Incrementador de alcalinidad
Alkalinity increase
Augmente l'alcalinité
Elevatore di alcalinità

ANTICALCÁREO ANTI LIME ANTI-CALCAIRE ANTICALCARE

ANTICALC

LÍQUIDO LIQUID LIQUIDE LIQUIDO



Ref.
76049

1 L pack 12



Ref.
76048

5 L pack 4



Para evitar la formación de cal.
Secuestrante de metales (hierro, cobre...)
To prevent lime formation.
Metal Sequestering Agents (iron, copper...)
Pour éviter la formation de calcaire.
Séquestrant de métaux (fer, cuivre, etc.)
Evita la formazione del calcare.
Sequestrante di metalli (ferro, rame)

PRODUCTO QUÍMICO PARA EL INVIERNO
CHEMICAL PRODUCTS FOR WINTER
PRODUITS CHIMIQUES POUR L'HIVER
PRODOTTI CHIMICI PER L'INVERNO

Le facilitará la puesta en marcha de la piscina después del invierno, evitando la formación de algas y de cal.

Realizar el proceso cuando la temperatura del agua de la piscina sea inferior a 15°C.

- 1) Limpiar la piscina.
- 2) Ajustar el pH entre 7,2 - 7,6
- 3) Realizar una cloración de choque
- 4) Dejar en funcionamiento el filtro hasta el día siguiente 5)
- Realizar una limpieza del filtro
- 6) Añadir el invernador

It makes easier for you the start-up of the pool after winter, avoiding algae and lime formation.

Please carry out the following if the temperature of the water drops below 15°C.

- 1) Clean the swimming pool
- 2) Set the pH balance between 7.2 – 7.6
- 3) Carry out a chlorine crash course
- 4) Leave the filter running until the following day
- 5) Clean the filter
- 6) Add the winterizing agent



INVERNADOR WINTERISER
HIVERNAGE TRATTAMENTO PER L'INVERNO

HIVERNAGE

LÍQUIDO LIQUID LIQUIDE LIQUIDO



Ref. 76050

1 L

pack 12



Ref. 76051

5 L

pack 4



Vous facilite la mise en route de la piscine après l'hiver en évitant la formation d'algues et de calcaire. Réaliser le processus lorsque la température de l'eau de la piscine est inférieure à 15°C.

- 1) Nettoyer la piscine
- 2) Ajuster le pH entre 7,2 - 7,6
- 3) Réaliser une chloration de choc
- 4) Laisser fonctionner le filtre jusqu'au lendemain
- 5) Nettoyer le filtre
- 6) Ajouter l'hivernant

Renderà più semplice l'inizio della nuova Stagione, dopo l'inverno, evitando la formazione di alghe e calcare.

Realizzare la procedura quando la temperatura dell'acqua della piscina è inferiore a 15°C.

- 1) Pulire la piscina
- 2) Regolare il pH tra 7,2 e 7,6
- 3) Effettuare una clorazione d'urto
- 4) Lasciare in funzione il filtro fino al giorno successivo
- 5) Effettuare una pulizia del filtro
- 6) Aggiungere lo svernante



INVERNADOR CONCENTRADO
CONCENTRATED WINTERISER
HIVERNAGE
CONCENTRÉ TRATTAMENTO PER L'INVERNO
CONCENTRATO

HIVERNAGE CONCENTRÉ

LÍQUIDO LIQUID LIQUIDE LIQUIDO



Ref. 76017

1 L

pack 12



INVERNADOR CON BOYA MULTIFUNCIÓN
MULTIACTION FLOAT WINTERISER
BOUÉE HIVERNAGE MULTI-ACTION
TRATTAMENTO PER L'INVERNO
GALLEGGIANTE MULTI FUNZIONE

HIVER FLOAT

PASTILLAS TABLETS PASTILLES PASTIGLIE



Ref. 76080

1,75 Kg

pack 8



■ producto químico ■ chemicals

GAMA QUÍMICO ECO ECO CHEMICALS PRODUITS D'ENTRETIEN ECO PRODOTTI CHIMICI ECO

REGULADORES DE PH • PH REGULATORS • RÉGULATEURS DE PH • CORRETTORI DI PH

	Minorador de pH granulado • Granules pH reduce • pH moins granulés • Riduttore pH granulato				
	5 Kg		REF. 90001	PACK 4	
	Minorador de pH liquido • Liquid pH reduce • pH moins liquide • Riduttore pH liquido				
	1l		REF. 90047	PACK 12	
	5l		REF. 90002	PACK 4	
	25l		REF. 90004	PACK 1	
	Incrementador de pH granulado • Granules pH increase • Augmente le pH granulés • Incrementatore pH granulato				
	4,5 Kg		REF. 90005	PACK 4	
	Incrementador de pH granulado • Granules pH increase • Augmente le pH granulés • Incrementatore pH granulato				
	1l		REF. 90048	PACK 12	
	5l		REF. 90006	PACK 4	

HIGIENIZANTES • SANITIZINGS • HYGIÉNISATION • IGIENIZZANTI

	Cloro lento tabletas 250 gr • Slow chlorine 250 gr tablets • Chlore lent galets 250 gr • Cloro Lento pastiglie 250g				
	1 Kg		REF. 90055	PACK 18	
	5 Kg		REF. 90010	PACK 4	
	PALETTE 5 Kg	 	REF. 90058	PAL 120	
	10 Kg		REF. 90012	PACK 2	
	Cloro choque pastillas 20 gr • Shock chlorine 20 gr tablets • Chlore choc pastilles 20 gr • Cloro shock pastiglie 20g				
	1 Kg		REF. 90078	PACK 20	
	5 Kg		REF. 90073	PACK 4	
	BOX 5 Kg	 	REF. 90203	BOX 42	
	PALETTE 5 Kg	 	REF. 90072	PAL 120	
	10 Kg		REF. 90074	PACK 2	

■ produits d'entretien ■ prodotti chimici



Cloro choque granulado • Granules shock chlorine • Chlore choc granulés • Cloro shock granulato

1 Kg		REF. 90050	PACK 20	
5 Kg		REF. 90020	PACK 4	
PALETTE 5 Kg		REF. 90060	PAL 120	
10 Kg		REF. 90021	PACK 2	



Cloro 4 acciones tabletas 250 gr • Chlorine 4 actions 250 gr tablets • Chlore 4 actions gallets 250 gr • Cloro 4 azioni pastiglie 250g

1 Kg		REF. 90052	PACK 18	
5 Kg		REF. 90025	PACK 4	
BOX 5 Kg		REF. 90200	BOX 60	
PALETTE 5 Kg		REF. 90057	PAL 120	
10 Kg		REF. 90027	PACK 2	
25 Kg		REF. 90028	PACK 1	



Cloro 5 acciones tabletas 250 gr • Chlorine 5 actions 250 gr tablets • Chlore 5 actions galets 250 gr • Cloro 5 azioni pastiglie 250g

5 Kg		REF. 90051	PACK 4	
------	--	------------	--------	--

TRATAMIENTO ANTIALGAS • ANTI-ALGAE TREATMENT • TRAITMENT ANTI-ALGUES • TRATTAMENTO ANTIALGHE

Antialgas liquido concentrado • Liquid anti-algae • Anti-algues liquide • Antialghe liquido concentrato



1l		REF. 90053	PACK 12	
5l		REF. 90030	PACK 4	
BOX 5l		REF. 90202	BOX 48	
10l		REF. 90032	PACK 1	

FLOCULANTE • FLOCCULANT • FLOCULANT • FLOCCULANTE

Floculante liquido • Liquid flocculant • Floculant liquide • Flocculante liquido



1l		REF. 90054	PACK 12	
5l		REF. 90042	PACK 4	
1Kg		REF. 90046	PACK 14	

Floculante cartucho • Cartridge flocculant • Floculant cartouche • Flocculante a cartuccia

INVERNADOR • WINTERISER • HIVERNAGE • PRODOTTI CHIMICI PER L'INVERNO

Invernador liquido • Liquid winteriser • Hivernage liquide • Trattamento per l'inverno liquido

5l		REF. 90035	PACK 4	
----	--	------------	--------	--

■ producto químico ■ chemicals

REF. 90175

DIS PACK 24



Repulsivo Anti Insectos a base de aceites esenciales 100% naturales. Dosifi cador de 3 pastillas de 30g.

Répulsif Anti Insectes à base d'huiles essentielles 100% naturelles. Doseur de 3 pastilles de 30g.

Anti Insect repellent using 100% natural essential oils. 30 g 3 tablet dosifier.

Repellente anti-insetti a base di oli essenziali 100% naturali. Dosatore di 3 pastiglie da 30g.



REF. 90178

DIS PACK 12



Repulsivo Anti Insectos a base de aceites esenciales 100% naturales. Caja de 6 pastillas de 30g.

Répulsif Anti Insectes à base d'huiles essentielles 100% naturelles. Boite carton de 6 pastilles de 30g.

Anti Insect repellent using 100% natural essential oils. 30g 6 tablet box.

Repellente anti-insetti a base di oli essenziali 100% naturali. Confezione di 6 pastiglie da 30g.



REF. 90147

DIS PACK 12



Stop Aguas Verdes

Recupera las aguas verdes gracias a una nueva generación de polimeros hidrosolubles. Caja de 6 pastillas de 20g.

Stop Eaux Vertes

Il récupère les eaux vertes grâce à une nouvelle génération de polymères hydrosolubles. Boite carton de 6 pastilles de 20g.

Stop Green Waters

Get back the green waters of your pool thanks to a new generation of water soluble polymers. 20g 6 tablet box.

Stop Acque Verdi

Recupera le acque verdi grazie ad una nuova generazione di polimeri idrosolubili. Confezione di 6 pastiglie da 20g.





REF. 90143

DIS PACK 12



Stop Aguas Turbias

Recupera las aguas turbias, y consigue un agua limpia y cristalina.
Caja de 6 pastillas de 30g.

Stop Eaux Troubles

Traite les eaux troubles, et rend l'eau propre et cristalline.
Boite carton de 6 pastilles de 30g.

Stop Cloudy Waters

Get back the cloudy waters to obtain a cristal-clear water.
30g 6 tablet box.

Stop Acque Torbide

Recupera le acque torbide, la sua efficacia permette di avere un'acqua limpida e cristallina.
Confezione di 6 pastiglie da 30g.



REF. SATC6

DIS PACK 12



Stop Aguas Turbias

Recupera las aguas turbias, y consigue un agua limpia y cristalina. Para piscinas con filtro de cartucho.
Caja de 6 pastillas de 17g.

Stop Eaux Troubles

Traite les eaux troubles, et rend l'eau propre et cristalline. Pour les piscines avec filtre à cartouche.
Boite carton de 6 pastilles de 17g.

Stop Cloudy Waters

Get back the cloudy waters to obtain a cristal-clear water. For pools with cartridge filter.
17g 6 tablet box.

Stop Acque Torbide

Recupera le acque torbide, la sua efficacia permette di avere un'acqua limpida e cristallina. Per le piscine con filtro a cartuccia.
Confezione di 6 pastiglie da 17g.

■ producto químico ■ chemicals

POOLP'OS POOLP'OS POOLP'OS POOLP'OS

- Solución de tratamiento "Todo en Uno". Ideal piscinas elevadas con o sin filtración. Tratamiento mensual.
- 4 Acciones: Higienizante, Antibacterias, Antialgas y Floculante
- No hay manipulación directa de producto químico. No perjudica la filtración gracias a su forma optimizada que deja el circuito de agua intacto. El POOLP'O sube a la superficie una vez acabado el producto químico, avisando de la necesidad de empezar un nuevo tratamiento.

- Solution de traitement "Tout en Un". Idéal Piscines hors-sol avec ou sans filtration. Traitement mensuel.
- 4 Actions: Hygiénisant, Anti-bactéries, Anti-algues, Floculant.
- Pas de manipulation directe de produit chimique. Ne gêne pas la filtration grâce à sa forme optimisée qui laisse le circuit de l'eau intact. Ne gêne pas le volet du skimmer de part sa petite taille. Le POOLP'O remonte à la surface une fois le produit consommé vous avisant de la nécessité de recommencer un traitement.

- Treatment solution "All in One" for Above ground Pools with and without filtration. Monthly treatment.
- 4 actions: Sanitizing, Anti-bacteria, Anti-algae and Flocculant.
- No direct handling of chemical product. It does not obstruct filtration thanks to its form optimized - which leaves the circuit of water intact. It goes up once product is finished, so you know you should start a new treatment.

- Soluzione "Tutto in uno". Adatto per piscine fuori terra con o senza filtrazione. Trattamento mensile
- 4 azioni: Igienizzanti, Anti- batteri, Antialghe e Floculante
- Non c'è contatto diretto con il prodotto chimico. Non danneggia la filtrazione grazie alla sua forma che lascia libero il circuito dell'acqua. El Poolp'o sale in superficie una volta terminato il prodotto chimico, avvisando della necessità di dover iniziare un nuovo trattamento

REF. 08012 BX PACK 16 8 427370 080128

POOLP'O 0-10m³ (250g)
POOLP'O 0-10m³ (250g)

REF. 08112 DIS 18 8 427370 081125

Display POOLP'O 0-10m³ (250g) 18 unidades
POOLP'O 0-10 m³ (250g) Display 18 unités

Display POOLP'O 0-10 m³ (250g) 18 units
Display POOLP'O 0-10 m³ (250g) 18 unità



REF. 08013A BX PACK 16 8 427370 080135

POOLP'O 10-20m³ (500g)
POOLP'O 10-20m³ (500g)

REF. 08113 DIS 18 8 427370 081132

Display POOLP'O 10-20m³ (500g) 18 unidades
POOLP'O 10-20m³ (500g) Display 18 unités

Display POOLP'O 10-20m³ (500g) 18 units
Display POOLP'O 10-20m³ (500g) 18 unità



REF. 08099A BX PACK 9 8 412081 250885

POOLP'O 10-30m³ (700g)
Dosificador flotante con tratamiento químico. Duración 3 semanas

POOLP'O 10-30m³ (700g)
Doseur flottant chimique tout en un. Durée 3 semaines.

POOLP'O 10-30m³ (700g)
Chemical treatment floating dispenser. 3 weeks

POOLP'O 10-30m³ (700g)
Dispenser galleggiante con trattamento chimici. 3 settimane.



KITS PISCINA POOL KITS
KITS POUR PISCINE KIT PER PISCINE



REF. 76053

PACK 12



Kit para piscina de 0 a 5m³
Cloro lento pastillas de 5 g - 500 g + Dosificador + Pelota

Kit for 0-5m³ pool
Trichlorine 5g tablets - 500 g + Dispenser + Ball

Kit pour piscine de 0 à 5m³
Chlore lent pastilles de 5 g - 500 g + Doseur + Ballon

Kit per piscine da 0 a 5m³
Cloro lento pastiglie da 5g - 500g + dosatore + palla gonfiabile



REF. 76054

PACK 6



Kit para piscina de 5 a 15m³
Multifunciones pastillas 20g, 1Kg + Dosificador + Termómetro + Analizador + Manguitos + Kit reparación liner

Kit for 5-15m³ pool
Multiactions 20g tablets, 1Kg + Dispenser + Thermometer + Test kit + Arm-bands + Liner repair kit

Kit pour piscine de 5 à 15m³
Multifonctions pastilles 20g, 1 kg + Doseur + Thermomètre + Trousse d'analyse + Brassards + Kit réparation liner

Kit per piscine da 5 a 15m³
4 azioni pastiglie da 20g, formato 1 Kg + Dosatore + termometro + Kit analisi + Bracciali + Kit riparazione liner



DIS PACK 12

REF. KTSPA

REF. KTSPA

REF. KTSPA



Kit tratamiento para Spa
Spa desinfectante 30g x4 + pH plus 20g x2 + pH menos 30g x2

Kit with chemical treatment for Spa
Spa disinfect 30g x4 + pH reduce 20g x2 + pH increase 30g x2

Kit traitement pour Spa
Sachets de désinfection 30g x4 + augmente pH 20g x2 + baisse pH 30g x2

Kit tratamiento per Spa
disinfezione Spa 30g x4 + incrementatore pH 20g x2 + riduttore pH 30g x2



REF. 778776

PACK 12



Clean SPA 3 en 1
Pastillas de 20 gr - 1 Kg.

Clean SPA 3 in 1
20g tablets, 1Kg

Clean SPA 3 en 1
Pastilles 20g, -1 kg

Clean SPA 3 in 1
Pastiglie da 20g, formato 1 Kg

Referencia no disponible para España

■ producto químico ■ chemicals

JUNIOR POOL

REF. KKP525

DIS PACK 18



8 412081 272597

**Kit tratamiento químico
para piscinas pequeñas
sin filtración**

5 bolsas de 25 ml

**Kit traitement chimie pour
petits bassins sans filtration**
5 x 25 ml

**Disinfection for small pools
without filter**
5 x 25 ml

**Kit trattamento per piscina
piccola senza filtrazione**
5 x 25 ml



TESTERS DIGITALES DIGITAL TESTERS TESTEURS DIGITAL TESTER DIGITALE

REF. 40817

BL PACK 12



0 909440 208208

Recambio para el
Aquacheck True Test: 25
tiras analíticas.

Recharge pour Aquacheck
TruTest: 25 languettes
d'analyse

Aquacheck True Test refill:
25 test strips.

Ricarica di Aquacheck
TruTest: 25 strisce di analisi.



REF. 38813

CS PACK 6



0 909441 040036

Aquacheck

Lector digital de tiras de
análisis TruTest. Analiza los
niveles de cloro/bromo libre,
valor pH y alcalinidad total.

Aquacheck

Lecteur digital de bandelettes
d'analyse TruTest. Résultats
de Chlore/Brome libre, pH et
Alcalinité totale.

Aquacheck

Digital Test Strip Reader.
Tests for: Free Chlorine, pH,
Total Alkalinity.

Aquacheck

Digital Test striscia lettore
TruTest: cloro / bromo-libero,
il pH e l'alcalinità totale.



■ produits d'entretien ■ prodotti chimici



REF. 40068

1/8 BL PACK 16



Análisis cloro + pH +
alcalinidad (50 tiras).

Analyse chlore + pH +
alcalinité (50 languettes).

Chlorine + pH + alkalinity
analysis (50 strips).

Analisi cloro + pH + alcalinità
(50 strisce).



REF. 40069

BX PACK 12



Analiza el nivel de sal en
agua (16 tiras).

Analyse le niveau de Sel de
l'eau (16 languettes).

Salt level in water analysis
(16 strips).

Analizza il livello di sale
nell'acqua (16 strisce).

MONODOSES MONODOSE
MONODOSE MONODOSI



REF. UFG90

DIS PACK 36



Ultraflock
Gel flocculante en monodosis
de 90g.

Ultraflock
Floculant Gel gousses de 90g.

Ultraflock
Flocculant Gel 90g pods.

Ultraflock
90g flocculante gel.

ANALIZADORES TEST KITS
TROUSSES D'ANALYSE KIT TEST

REF. 40060

BL PACK 16



8 427370 400605

Analizador de cloro/bromo +
pH (Oto/Phenol)

Trousse chlore/brome + pH
(Oto/Phénol)

Test kit chlorine/bromine +
pH (Oto/Phenol)

Kit analisi cloro/bromo + pH
(oto/Phenol)



REF. 40061

BL PACK 12



8 427370 400612

Recambio Oto/Phenol
Recharge Oto/Phénol

Refi II Oto/Phenol
Ricambio Oto/Phenol



REF. 40062

DIS 1/8 CS PACK 24



8 427370 400629

Comparador cloro + pH -
pastillas DPD1

Trousse chlore + pH -
pastilles DPD1

Test kit chlorine + pH - DPD1
tablets

Kit analisi cloro + ph -
pastiglie DPD1



REF. 40063

DIS 1/8 BL PACK 24



8 427370 400636

Recambio pastillas DPD1
Recharge pastilles DPD1

Refi II DPD1 tablets
Ricarica pastiglie DPD1





REF. 40066

DIS 1/8 CS PACK 24



Kit de análisis de oxígeno/
bromo + pH - pastillas DPD4

Trousse d'oxygène/brome +
pH pastilles DPD4

Oxygen / bromine + pH test
kit - DPD4 tablets

Kit analisi ossigeno/bromo +
pH pastiglie DPD4



REF. 40067

DIS 1/8 BL PACK 24



Recambio pastillas DPD4

Recharge pastilles DPD4

Refi II DPD4 tablets

Ricarica pastiglie DPD4

material plv pos material matériels plv materiale pos



EXPOSITOR PISCINA CHAPA STEEL POOL EXHIBITOR
EXPOSANTS PISCINE ACIER EXPOSITORI PISCINE PARETI IN ACCIAIO



TOTEMS CARTÓN CARDBOARD TOTEMS
TOTEMS CARTON TOTEMS CARTONE



FOLLETOS LEAFLETS
DÉPLIANTS VOLANTINI



EXPOSITOR ROBOTS
ROBOTS EXHIBITOR
EXPOSITEURS ROBOTS
EXPOSITORI ROBOTS

TOTEM ENTERRADAS
IN GROUND
POOLS TOTEM
TOTEM PISCINES
ENTERRÉES
TOTEM PISCINE
INTERRATA



PISCINA DE EXPOSICIÓN
EXHIBITOR WOODEN POOL
PISCINE BOIS D'EXPOSITION
EXPOSITORI PISCINA IN LEGNO



Nos reservamos el derecho de cambiar total o parcialmente las características de nuestros artículos o el contenido de este documento sin previo aviso. Fotos e imágenes no contractuales.

We reserve the right to change all or part of the articles or contents of this document without prior notice. Photos and pictures are not contractual.

Nous nous réservons le droit de modifier totalement ou en partie les caractéristiques de nos articles ou le contenu de ce document sans préavis. Photos et images non contractuelles.

Ci riserviamo il diritto di cambiare totalmente o parzialmente le caratteristiche tecniche dei nostri prodotti ed il contenuto di questo documento senza nessun preavviso. La Fotografia o il disegno è solo a scopo illustrativo ed informativo.

Sede social Headquarters | **Siège social** | **Sede centrale**

Manufacturas GRE S.A. | Aritz Bidea n° 57 | Belako Industrialdea | Apartado 69 | 48100 Mungia (Bizkaia) Spain

Tel. (34) 946 741 116 | Fax (34) 946 741 708 | gre@gre.es

Bureau Commercial France

Pintor Velazquez n°10 | 08213 Polinyà (Barcelona) | Spain

Tel : 09 73 32 57 01 | Fax : 09 73 32 57 00 | gre@grefrance.fr

Servicio Postventa | **After-sales service** | **Service après-vente** | **Servizio post-vendita**

WWW.SERVICE-GRE.COM

www.grepool.com



www.grepool.com

Manufacturas GRE S.A. | Aritz Bidea nº 57 | Belako Industrialdea | Apartado 69 | 48100 Mungia (Bizkaia) Spain
Tel. (34) 946 741 116 | Fax (34) 946 741 708 | gre@gre.es

FLUIDRA